



This is a digital copy of a book that was preserved for generations on library shelves before it was carefully scanned by Google as part of a project to make the world's books discoverable online.

It has survived long enough for the copyright to expire and the book to enter the public domain. A public domain book is one that was never subject to copyright or whose legal copyright term has expired. Whether a book is in the public domain may vary country to country. Public domain books are our gateways to the past, representing a wealth of history, culture and knowledge that's often difficult to discover.

Marks, notations and other marginalia present in the original volume will appear in this file - a reminder of this book's long journey from the publisher to a library and finally to you.

Usage guidelines

Google is proud to partner with libraries to digitize public domain materials and make them widely accessible. Public domain books belong to the public and we are merely their custodians. Nevertheless, this work is expensive, so in order to keep providing this resource, we have taken steps to prevent abuse by commercial parties, including placing technical restrictions on automated querying.

We also ask that you:

- + *Make non-commercial use of the files* We designed Google Book Search for use by individuals, and we request that you use these files for personal, non-commercial purposes.
- + *Refrain from automated querying* Do not send automated queries of any sort to Google's system: If you are conducting research on machine translation, optical character recognition or other areas where access to a large amount of text is helpful, please contact us. We encourage the use of public domain materials for these purposes and may be able to help.
- + *Maintain attribution* The Google "watermark" you see on each file is essential for informing people about this project and helping them find additional materials through Google Book Search. Please do not remove it.
- + *Keep it legal* Whatever your use, remember that you are responsible for ensuring that what you are doing is legal. Do not assume that just because we believe a book is in the public domain for users in the United States, that the work is also in the public domain for users in other countries. Whether a book is still in copyright varies from country to country, and we can't offer guidance on whether any specific use of any specific book is allowed. Please do not assume that a book's appearance in Google Book Search means it can be used in any manner anywhere in the world. Copyright infringement liability can be quite severe.

About Google Book Search

Google's mission is to organize the world's information and to make it universally accessible and useful. Google Book Search helps readers discover the world's books while helping authors and publishers reach new audiences. You can search through the full text of this book on the web at <http://books.google.com/>

Library
of the
University of Wisconsin



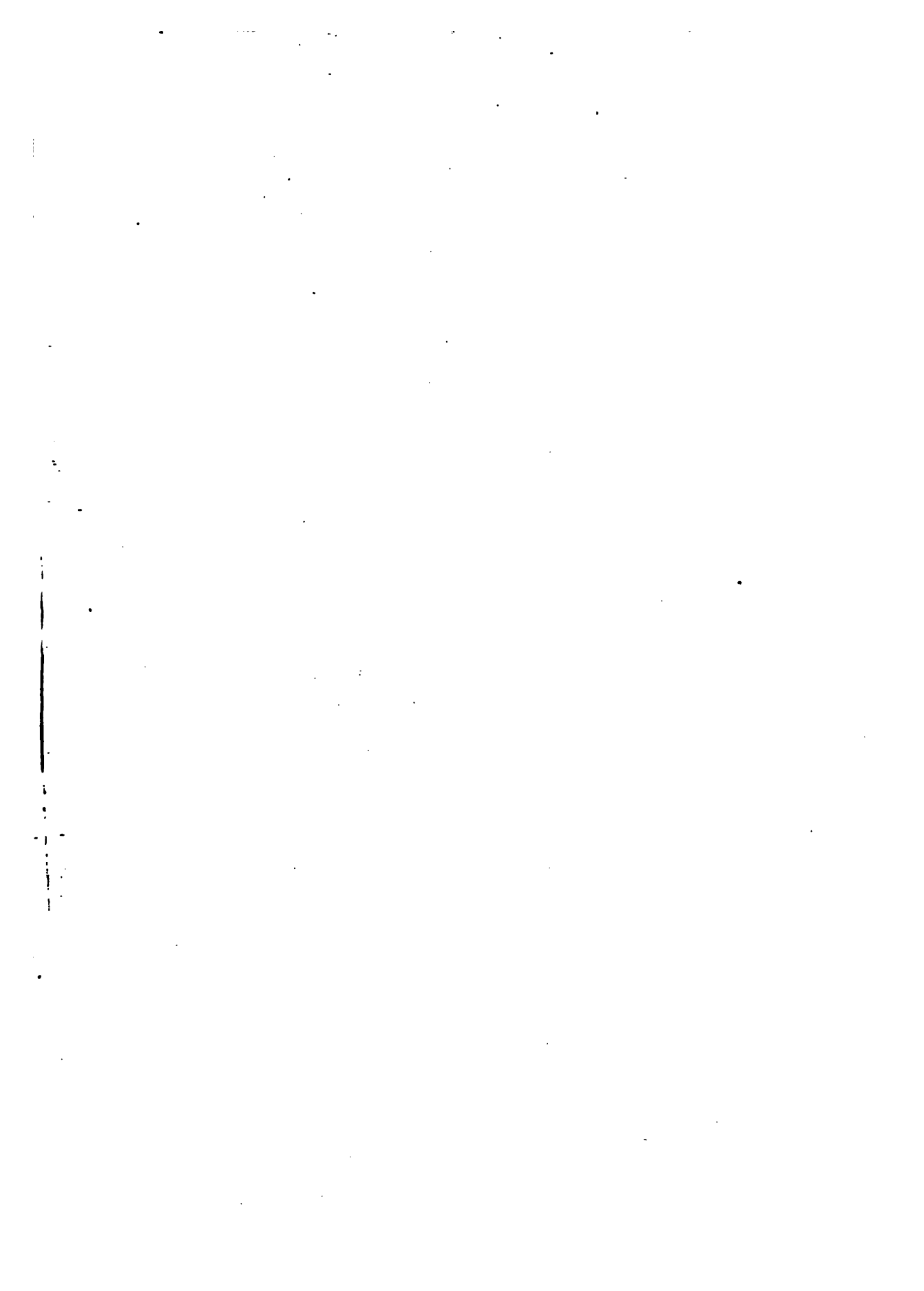



CONCRETE-STEEL CONSTRUCTION

(DER EISENBETONBAU)

BY

PROFESSOR EMIL MÖRSCH

Of the Zurich Polytechnic, Zurich, Switzerland

AUTHORIZED TRANSLATION FROM THE

THIRD (1908) GERMAN EDITION, REVISED AND ENLARGED

BY

E. P. GOODRICH

Consulting Engineer

NEW YORK

THE ENGINEERING NEWS PUBLISHING COMPANY

LONDON: ARCHIBALD CONSTABLE AND COMPANY, LTD.

1909

Copyright, 1909,

BY

THE ENGINEERING NEWS PUBLISHING COMPANY

Entered at Stationers' Hall, London, E.C., 1909

139340

6132369

FEB 10 1910

SDHC

NI 3

EGG

PREFACE TO SECOND EDITION

In the absence of a uniform literature, and in view of the number of profusely recommended systems, the first edition of this work, published by the firm of Wayss & Freytag in 1902, effected the purpose of familiarizing those interested in the scientific principles of reinforced concrete with all the experimental researches available at that time. The firm in question was impelled to publish it because systems based on wholly unscientific methods of calculation, and offering no adequate security, were being pushed into recognition by systematic advertisement, so that the danger was imminent that reinforced concrete would forfeit a large proportion of the confidence it already enjoyed, especially if a few failures should occur.

More than a year after the publication, in connection with the first edition, of information in regard to reinforced concrete, were published the "Leitsätze" (Recommendations) of the Verbands Deutscher Architekten und Ingenieur-Vereine, and of the Deutscher Beton Verein, as well as the "Regulations" (Bestimmungen) of the Prussian government, but they harmonized exactly with those of the first edition. The publication of the second edition had another purpose. The "Leitsätze" and the official "Regulations" had inspired widespread confidence in the new method of building, but even the best of directions could not altogether obviate mistakes and failures, where the proper knowledge of the coöperative effects of the two materials—steel and concrete—was lacking. In addition to this, all directions presumed a knowledge of approved rules of construction, as the "Leitsätze" could not possibly be amplified into a book of instructions on reinforced concrete. This knowledge was, however, very difficult to obtain from the class journals and other literature, because in these, all sorts of systems were simultaneously described, and conflicting opinions were also expressed.

The active part taken by the firm of Wayss & Freytag, as well as the undersigned, Prof. E. Mörsch, in the compilation of the preliminary "Recommendations," and the interest they manifested in making them final, caused them to bring out the present second edition, which represents a complete revision of the first edition, and facilitates the application of the "Leitsätze."

The general portion deals with examples chiefly relating to the practical reinforcement of T-beams, columns, and arches, under the most widely varied loads. The succeeding, and most comprehensive part, treats of the theory of reinforced concrete, covers exhaustively the properties of materials, and then

applies the theory in the closest possible manner to the results of the tests. The author has avoided a repetition of useless theories on reinforced work, of which there is no lack. On the other hand, he has succeeded in showing by means of tests that the methods of calculation given in the "Leitsätze" (which are identical with those published in the first edition) are well founded and useful. At the same time the actual distribution of stress in reinforced sections was thoroughly studied. The firm of Wayss & Freytag placed the whole of their experimental data (in great part hitherto unpublished) at the disposal of the author in the preparation of the work. In addition Bach gave the valuable results of the tests conducted for the reinforced concrete commission of the Jubiläumstiftung der Deutschen Industrie, published in the course of the current year, especially those relating to adhesion.

The third portion, covering the uses of reinforced concrete, reviews the most important fields of its utilization. All the examples cited represent work done by the firm of Wayss & Freytag, and, for the most part, executed under the direction of the author in his capacity as director of the Technical Bureau of the before-mentioned firm, selected from their fifteen years' experience in reinforced concrete work. This limitation of the choice of examples is warranted, inasmuch as all the reinforced construction work completed by the firm in question during the past five years has been calculated in accordance with the methods recommended in the "Leitsätze," and in accord with the rules given in the theoretical and general sections of the book regarding construction work.

The field of employment for reinforced concrete is constantly widening; there can therefore be no claim raised that it has been completely covered; only the most important features have been presented. But the operations of this single firm give an excellent idea of the versatility of the employment of reinforced concrete.

The firm is well aware that the material herewith presented is of service to their competitors, but believe that by a general deepening of knowledge of reinforced concrete, they are rendering the most service to the subject.

WAYSS & FREYTAG.

Neustadt, a. d. Haardt, November, 1905.

PROFESSOR E. MÖRSCH.

Zurich, November, 1905.

PREFACE TO THIRD EDITION

OWING to the quick sale of the second edition, at the request of the publishers and of the firm of Wayss & Freytag, the undersigned undertook the preparation of a third edition. Of the new experiments conducted by the firm in the interim, special attention must be called to those relating to shear in T-beams and those made upon continuous beams.

These experiments, in connection with the recently published results of the tests undertaken for the Reinforced Concrete Commission of the Jubiläumstiftung der Deutschen Industrie, by the Testing Laboratory at Stuttgart, made possible a detailed treatment of the subject in question. Compared with the preceding editions it is here that the principal additions occur. In addition, the theoretical chapters relating to flexure and bending with axial stress, were considerably extended. In the applications, the chapters on buildings, columns, and silos have likewise been enlarged.

In the preface to the second edition, the grounds were given that led to the exclusive use of the work of the firm of Wayss & Freytag. These reasons still apply in regard to the new edition, for most of the examples referred to in the applications were made under the author's direction, and he also furnished the firm with the suggestions for the new tests. The author has also collaborated, as a member of the Commission, in the program of tests conducted by the Testing Laboratory at Stuttgart.

In view of the present general development of reinforced concrete the standpoint of this work may possibly be designated as one-sided. It may be answered that the present advance in the art is, in large part, due to the efforts of the firm of Wayss & Freytag, and that, on the other hand, no complete presentation of all of the applications of reinforced concrete are contemplated, because the scope of this work is much too limited.

PROFESSOR E. MÖRSCH.

Zurich, November, 1907.

PUBLISHERS' NOTE

PROFESSOR MORSCH'S "*Eisenbetonbau*" is probably the clearest exposition of European methods of reinforced concrete construction that has yet been published. It has for some years been a recognized standard in Europe and has also had a considerable demand in this country, but the comparatively limited usefulness of the German edition to American engineers prompted us to make arrangements with Professor Mörsch for the rights of translation and publication of the book in the English language.

In the original German edition there is no division into chapters, but for the sake of clearness and system, and in conformity with American custom, the translation has been divided into parts, (1) The Theory of Reinforced Concrete, and (2) The Applications of Reinforced Concrete, which have been subdivided into Chapters and an Appendix.

On account of the impossibility of securing the original drawings and photographs from which to make reproductions for illustration, it was necessary to import electros of the cuts used in the German book. Wherever possible, the wording of these has been translated into English and altered in the cut, but in many cases such alterations were impossible and the German lettering has been left.

The measurements used in the German editions were in the metric system only; in the translation, the metric system has been retained, but the English equivalents are given wherever measurements are quoted, as well as in all tables. Furthermore, a table of metric and English equivalents has been included at the end of the book.

It is hoped that the efforts of the publishers to make available to English-speaking engineers the contents of this valuable work will merit their approval and appreciation.

THE ENGINEERING NEWS PUBLISHING COMPANY,
Book Department.

New York, November, 1909.

CONTENTS

INTRODUCTION

| | PAGE |
|-----------------------|------|
| CHAPTER I. Slabs..... | 4 |
| T-Beams | 8 |
| Columns | 11 |
| Arches | 14 |

PART I

THEORY OF REINFORCED CONCRETE

| | |
|---|-----|
| CHAPTER II. Strength and Elasticity | 15 |
| Steel | 16 |
| Concrete | 18 |
| Strength and Elasticity of Concrete | 19 |
| Elasticity Test of Concrete | 23 |
| CHAPTER III. Shear, Adhesion, Torsion | 31 |
| CHAPTER IV. Extensibility | 50 |
| CHAPTER V. Compression | 59 |
| CHAPTER VI. Simple Bending | 74 |
| Rectangular Sections—Slabs | 76 |
| Rectangular Sections, Double Reinforcement..... | 87 |
| CHAPTER VII. Actual Ultimate Bending Tests of Reinforced Slabs in their Relation to Theory | 90 |
| Bending Tests of Concrete Beams with Double Reinforce- ment | 93 |
| CHAPTER VIII. Bending with Axial Forces | 119 |
| Bending with Axial Tension | 127 |
| Graphical Methods of Calculation | 130 |
| Method of Computation for Stage IIa | 137 |
| CHAPTER IX. Effects of Shearing Forces | 139 |
| Formulas for Shearing and Adhesive Stresses | 141 |

| | PAGE |
|---|------|
| CHAPTER X. Experiments Concerning the Action of Shearing Forces . . . | 151 |
| CHAPTER XI. Stuttgart Experiments Concerning Shear, Continuous Members, etc. | 174 |
| Deductions from the Experiments. | 181 |
| Shearing Stresses in Beams of Variable Depth. | 190 |
| Deformation | 192 |
| Computation of Forces and Moments | 194 |
| Experiments with Continuous T-Beams | 199 |

PART II

APPLICATIONS OF REINFORCED CONCRETE

| | |
|--|-----|
| CHAPTER XII. Historical. | 204 |
| Buildings | 209 |
| Stairs | 232 |
| Arches in Buildings | 235 |
| Spread Footings | 241 |
| Sunken Well Casings | 244 |
| Water-tight Cellars | 247 |
| Piles | 250 |
| CHAPTER XIII. Bridges | 256 |
| With Horizontal Members. Slab Culverts | 256 |
| Arch Construction | 267 |
| Reservoirs | 284 |
| Silos | 287 |

APPENDIX

| | |
|---|-----|
| PRELIMINARY RECOMMENDATIONS (LEITSÄTZE) FOR THE DESIGN, CONSTRUCTION, AND TESTING OF REIN- FORCED CONCRETE STRUCTURES | 317 |
|---|-----|

- I. General.
- II. Building Preliminaries.
- III. Checking Plans.
- IV. Building Construction.
 - a. Supervision of Work and Employees.
 - b. Materials and Their Handling.
 1. Reinforcement.
 2. Cement.
 3. Sand, Gravel, and other Aggregates.
 4. Concrete.
 - c. Forms and Supports. Time of Removal.
 - d. Protection of Structural Parts.

- V. Inspection and Test of Work.
 - a. Tests during Erection.
 - b. Tests after Completion.
 - c. Duties of the Contractor.
- VI. Exceptions.

APPENDIX TO THE FOREGOING RECOMMENDATIONS REGARDING METHODS OF CALCULATION TO BE USED IN TESTING REINFORCED CONCRETE STRUCTURES... 321

- I. Fundamental Assumptions.
 - a. External Forces.
 - 1. Loads.
 - 2. Reactions, Moments, and Shears.
 - b. Internal Forces.
 - c. Safe Stresses.
- II. Approximate Methods of Computations.
 - a. Simple Bending.
 - 1. Rectangular Sections. Slabs.
 - 2. T-Beams.
 - b. Compression.
- III. Supports for Safe Loads .
- IV. Examples of the Method of Computation for a Few Simple Cases.
 - a. Simple Bending.
 - 1. Slabs.
 - 2. T-Beams.
 - 3. Continuous T-Beams.
 - b. Compression, Columns.

REGULATIONS OF THE ROYAL PRUSSIAN MINISTRY OF PUBLIC WORKS, FOR THE CONSTRUCTION OF REINFORCED CONCRETE BUILDING, MAY 24, 1907 333

- I. General.
 - a. Testing.
 - b. Construction.
 - c. Removal of Forms.
- II. Recommendations for Statical Computations.
 - a. Dead Load.
 - b. Determination of External Forces.
 - c. Determination of Internal Forces.
 - d. Permissible Stresses.
- III. Methods of Calculation, with Examples.
 - a. Simple Bending.
 - b. Central Loading.
 - c. Eccentric Loading.
 - d. Examples



CONCRETE-STEEL CONSTRUCTION

(Der Eisenbetonbau)

CHAPTER I

INTRODUCTION

REINFORCED CONCRETE (Eisenbeton) is the name given to all varieties of construction in which are combined cement-concrete and steel, in such manner that the two elements acting together, statically resist all external forces.

In this connection it is to be understood that the concrete resists compressive stresses principally, while the steel resists tensile ones in large measure—that is, gives the concrete a higher tensile strength. In this type of construction many advantages and valuable properties result from the combination of these two quite dissimilar materials. Buildings erected in this manner combine the massiveness of concrete with the lightness of steel construction, and their wide distribution and daily growth in numbers is due to considerable economic advantages possessed by reinforced concrete over corresponding work in stone, wood or iron. Besides being cheaper in first cost than iron or wood, practically all maintenance charges can be eliminated in reinforced concrete, because of the rational manner in which use is made of the wearing qualities of the two elements. Another excellent property of reinforced-concrete work is its resistance to fire. Because of this quality, concrete has been employed for some time in building work, in the shape of partitions and stairways, and for the fireproofing of steel beams and columns. Now, columns and beams are built of the same materials which were formerly used simply for fireproofing purposes, and in this way is secured a more uniform and cheaper fireproof construction.

These several advantages, and the usefulness of reinforced concrete for the structural parts of beams, columns, and floor slabs, arise from the following fundamental properties of concrete and steel in combination:

1. **Steel Covered with Concrete is most Perfectly Protected by it against Corrosion.** This is now a recognized fact, but it should be added that only with relatively rich mixtures, and with a plastic condition of the concrete (not earth-moist) can there be attained the intimate covering and adhesion necessary to give proper protection. If a leaner and drier mixture is employed, it

is necessary to wash the reinforcement with cement grout just before the deposit of the concrete, to obtain the desired adhesion and security against rust.

As a proof of the existence of this property of protecting against rust, there may be cited the numerous reinforced-concrete reservoirs and sewers which have already stood for several decades and as yet show no signs of any corrosion of the reinforcement. Some examinations of twenty-year old sewers showed the steel absolutely uninjured and of the same color as when it left the rolling mill. Additional proofs are constantly being adduced by the repeated loading of structures, and through the demolition of old reservoirs and floors, in none of which has ever been disclosed any corrosion of properly covered reinforcement, even when of considerable age. Bauschinger gives the following report of some observations as to freedom from corrosion in several test specimens which had been broken in October, 1887, and had lain in the open air till 1892:

"From several slabs, the concrete covering the reinforcement was knocked away with a hammer. The chips broke only in small pieces where the concrete was struck, showing good adhesion between the steel and the concrete, and the exposed reinforcement was entirely free from rust, even close to fractured edges.

"A tank was cracked and otherwise damaged through rough treatment during transportation, so that the reinforcement was partially exposed. Naturally, the portion longest exposed showed corrosion, and some rust was revealed when the concrete was removed adjacent to an old crack. However, when the metal was exposed under an unbroken, hard surface, no rust was revealed and the same adhesion was observed as in the slabs.

"On July 23, 1892, several fragments of floor slabs 6 to 8 cm. (2.4 to 3.1 in.) thick, were examined. They had lain around the end of a sewer, and the pieces next the entrance were most of the time covered with water which often contained sewage. According to a statement of the owner, the pieces had been in place about four years, and had been purchased by him at the sale of the fragments of the tests made in 1887. They plainly showed the fractured ends from which the reinforcement stuck about 5 cm. (2 in.). On one piece which lay somewhat lower than the others, the reinforcement was scarcely 1 cm. (0.4 in.) beneath the upper surface. This upper layer was chiseled away, the concrete proving very hard and adhering firmly to the steel. The latter was absolutely rustless to within a distance of 1 cm. (0.4 in.) from the fractured edge." (See *Beton und Eisen*, No. IV, 1904, p. 193.)

2. The Adhesion between Embedded Steel and Cement Concrete is Considerable and about equal to the shearing strength of concrete. This adhesion can be demonstrated by direct experiment, but its presence is clearly shown by the great bending strength of reinforced concrete slabs as compared with those of plain concrete. This bending resistance, with reinforcement aggregating 1% of the cross-section, amounts to 178 kg/cm² (2532 lbs/in²) and increases to 247 kg/cm² (3513 lbs/in²) with 1.45% of reinforcement; whereas the bending strength of a plain concrete slab of similar section amounts at most to 47 kg/cm² (668 lbs/in²). If adhesion were lacking, slabs with embedded steel would show smaller bending strength than similar slabs without reinforcement, because of the diminished net concrete section.

For some time adhesive strength was assumed as 40 kg/cm² (569 lbs/in²) as found by Bauschinger, and until lately its actual value was considered unim-

portant, since adhesion was never taken into account in making computations. However, this point is of great importance, and the anchorage of reinforcing rods should always be investigated.

Other tests will be discussed later.

With an adhesive strength of 35 kg/cm^2 (498 lbs/in^2), the length to which a rod must be embedded in concrete so that its tensile strength (3600 kg/cm^2 , or $51,200 \text{ lbs/in}^2$) is exceeded by the adhesion developed, will be, for a round rod of

| | |
|-----------------------|------------|
| 10 mm. diameter, | 26 cm. |
| ($\frac{3}{8}$ in.) | (10.2 in.) |
| 20 mm. “ | 52 cm. |
| ($\frac{3}{4}$ in.) | (20.4 in.) |
| 30 mm. “ | 78 cm. |
| ($1\frac{1}{8}$ in.) | (30.6 in.) |

and it is seen that the transfer of stress from the concrete to the steel, or *vice versa*, may be considered as proportional for shorter lengths.

Furthermore, as an additional precaution against slipping (which costs very little extra) the ends of all rods should be hooked.

3. The Coefficients of Linear Expansion by Heat of Steel and Concrete are Practically Identical. The coefficients were determined by Bonniceau (*Annals des ponts et chaussées*, 1863, p. 181) for 1° C. as

0.00001235 for steel rods, and

0.00001370 for Portland cement concrete,

but it is to be understood that the coefficient for concrete is subject to small variations from differences in the quality of the aggregate.

Some experiments of Keller published in No. 24 of the *Tonindustriezeitung*, 1894, may be cited further. The concrete of the test specimens consisted of part gravel, of particles of 20 mm. ($\frac{3}{4}$ in.) diameter, and part Rhine sand. The average coefficients of linear expansion for 1° C. , between -16° and $+72^\circ \text{ C.}$, were as follows:

| | | |
|--------------|-------------|-----------|
| Mixture 1:0, | coefficient | 0.0000126 |
| “ 1:2, | “ | 0.0000101 |
| “ 1:4, | “ | 0.0000104 |
| “ 1:8, | “ | 0.0000095 |

The coefficient for steel is usually assumed as 0.000012.

Since the coefficients of expansion by heat are so nearly equal, the objection formerly made against reinforced concrete is therefore groundless—that the necessary adhesion which must exist between two such dissimilar materials as compose it, would be endangered by changes of temperature. In any case, the temperature of thoroughly encased steel cannot be far different from that of its concrete cover. Furthermore, being poor conductors, such bodies will

absorb very little heat, and this absorption will take place only very slowly and at points directly exposed to temperature effects. The concrete cover therefore protects the reinforcement very effectively against temperature change.

According to official fire tests, a failure of adhesion which would be dangerous to strength does not take place even with large and sudden temperature changes (see "Das System Monier," 1887, by G. A. Wayss). With usual differences in temperature the variation in expansion is compensated by small internal stresses (*Zeitschrift des Oesterr. Arch- und Ingenieur-Vereins*, 1897, No. 50).

The variation in volume of concrete, due to its humidity, has the greatest influence upon the distribution of the stress between the steel and the concrete. Through experiments, especially those of the French Commission,* it has been determined that concrete which sets in air, shrinks; while that which sets under water expands. General, accurate figures for the different kinds of cement, and their different mixtures, cannot be given, although these phenomena are worthy of more attention on the part of designers than they have hitherto received.

The several structural parts of reinforced concrete buildings are slabs, T-beams, columns and arches—the characteristics of each of which will first be briefly described.

SLABS

Slabs are the simplest reinforced-concrete constructions built to resist bending stresses. It is well known that in a slab simply supported at each end and centrally loaded, the upper layers are subjected to compressive stresses, while the lower layers are acted upon by tensile ones. Since the tensile strength of concrete is much smaller than its compressive strength, the failure of such a concrete slab will take place through exceeding the ultimate tensile strength. It is the province of the added reinforcement to overcome this defect, and increase the resultant strength of the structure, by carrying the major part of the tensile stresses. The reinforcement must be designed so as to have its strength in a proper ratio to the compressive strength of the concrete.

In slabs assumed as simply supported at the ends, the reinforcing rods should run parallel with the lines of action of the tensile stresses, and should lie as close to the bottom of the slab as is consistent with proper protection. With good mortar, small rods may be properly covered with 0.5 cm. (0.2 in.) of concrete; while slightly heavier material should have at least 1 cm. (0.4 in.) of covering, and still larger rods should be placed at greater distances above the bottom of the slab. Usually, in addition to these "carrying rods," others at right angles to them, called "distributing rods," are installed. They are primarily employed to keep the carrying rods properly spaced during the construction of the slab, and the two series are therefore wired together at points of intersection.

Of course, the number and size of these distributing rods must depend upon

* Commission du ciment armé. Expériences, rapports, etc., relatives à l'emploi du béton armé. Paris. H. Dunod et F. Pinat, 1907.

the conditions of loading and support. They also assist in distributing concentrated loads over a larger carrying area of the slab.

If the slabs are supported on four sides, the heavier carrying rods are laid in the direction of the shorter span, and the smaller distributing rods, perpendicular to it. The section of the carrying rods must vary as the span and the load to be carried. Their spacing should be from 5 to 15 cm. (2 to 6 in.), and it is to be noted that light rods, closely spaced, carry more than larger rods with greater spacing. The criterion for calculating this spacing is the unit adhesive stress on the surface of the rods over the supports. The diameter of the distributing rods is usually 5 to 7 mm. ($\frac{3}{16}$ to $\frac{1}{4}$ in.) and their spacing 10 to 40 cm. (4 to 16 ins.).

The distributing rods have another important province in cases where conditions are such that stresses due to temperature change are set up in the slab at right angles to the carrying rods. In such cases the distributing rods take up the stresses and thereby prevent cracking. Sometimes a light system of reinforcement is installed near the upper surface of a slab. This is done where absolute freedom from cracking is necessary, and where large secondary stresses are to be expected, due to shrinkage or temperature change.

Above, have been considered only slabs freely supported at their ends. In most constructions, however, a certain amount of restraint is experienced where slabs are supported in outside walls, and many slabs run continuously over girders of rolled beams or of reinforced concrete. Because of this restraint, due to continuity of structure, the moment at the middle of the slab span is reduced, but bending moments of opposite kind are produced over the supports, and because of this condition, reinforcement must be introduced near the tops of the slabs in the vicinity of the supports, so as to take up the tensile stresses

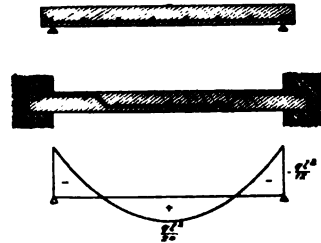

FIG. 1.

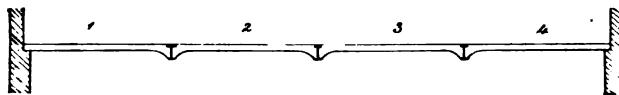

FIG. 2.

at those points. In this way is derived the type of bent rod, originally used by Monier, which corresponds (in its relation to the neutral axis) with the line of maximum moments. A single type of bent rods is usually not sufficient, since moving loads must be considered. More frequently, both a maximum and a minimum moment line is involved, to which the reinforcement must correspond. Frequently, too, it is necessary to employ continuous top rods, especially when a short span adjoins a long one. (See Fig. 1.)

Fig. 3 shows in detail the arrangement of reinforcement employed in the continuous slab of Fig. 2, consisting of four spans supported between I-beams. The dotted line in Fig. 4, which is drawn between the two maximum moment lines, represents the moments under conditions of perfect restraint at the ends

and a uniformly distributed load. Under such conditions the moment is $\frac{ql^2}{24}$ in the center, and $-\frac{ql^2}{12}$ at the ends.

Continuous reinforced concrete floors between I-beams are usually constructed with slightly arched ceilings, the arches being formed by constructing haunches down to the lower flanges of the beams. The advantage of these

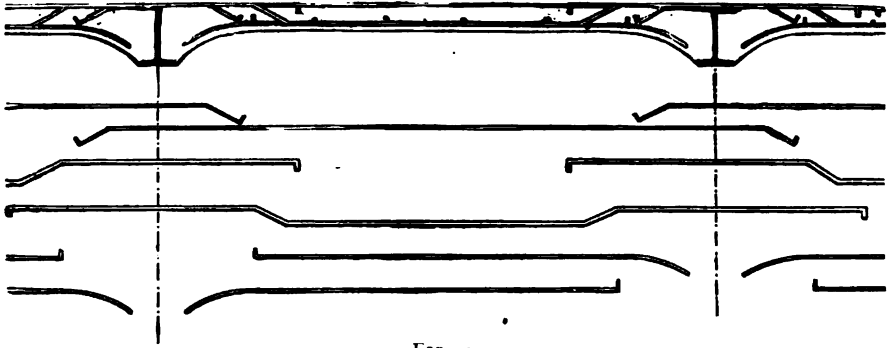

FIG. 3.

haunches is that for the moments near the supports (which exceed those at the centers) the concrete has been so increased in depth that no special increase in reinforcement is necessary. An increase in the section of concrete at the supports is needed, if the slab thickness at the center of the span is so thin as just to resist the compression at that point. If this thickness were carried over the intermediate supports, the concrete would be over-stressed at those points. According to the theory of continuous beams with variable section, because

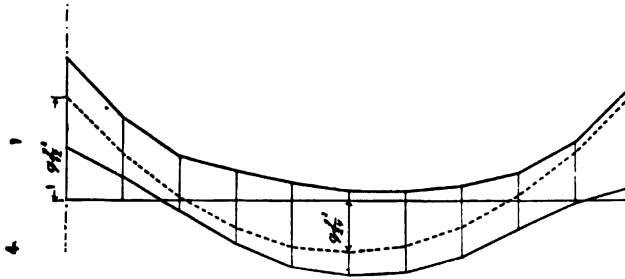

FIG. 4.

of the arch form of the slab, a slight reduction results in the moments at the centers of the spans, with a corresponding increase of those over the supports. Since ample reinforcement is generally provided at the latter points, the exact and detailed computation of moments may be omitted in most practical cases.

In the same manner, floor slabs which run continuously over reinforced concrete girders must be reinforced. (See Fig. 5.) For want of accurate knowledge concerning the matter, no account is taken, in either case, of the torsional resistance exerted by the rolled steel or reinforced concrete beams. Thus, a somewhat larger factor of safety is secured.

In thin slabs up to about 10 cm. (3.9 in.) thickness, the bending of the rods should be done with a slope of 1:3. In thicker and shorter slabs the slope can be steeper—1:2 to 1:1½. It is evident, in this connection, that in all continuous slabs, without regard to an arrangement to fit the distribution of moments, so much reinforcement must be bent that the bent portion is able to carry the whole load of the central portion of the slab over into the ends, which act as cantilevers, even though the slab be cracked entirely through in the vicinity of the bends. This rule is easy to follow, and is the more important the less the amount

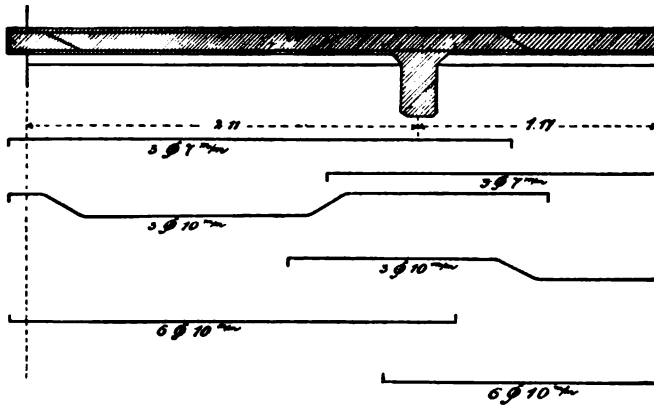

FIG. 5.

of straight reinforcement and the more the concrete is exposed to outside stresses from shrinkage and temperature change.

Instead of finishing the ends of the straight and bent rods as hooks, it is evident, under such circumstances, that the ends which lie next the centers of the slabs can remain straight and simply be anchored in the zone of compression of the concrete.

The number of "systems" of reinforced concrete floors is large, and new "systems" are constantly being devised. In most cases, however, their newness does not include any improvements. As stated before, many systems are at fault in that no reinforcement is provided near the upper surface over the beams, as computations show necessary, reinforcement being used only near the bottom; while others employ a wrong distribution between the upper and lower systems of rods.

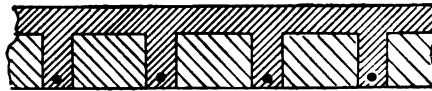

FIG. 6.

One improvement in such floor systems aims at a separation, as far as possible, of the zones of tension and compression, without essentially increasing the total weight of the structure. This is accomplished by employing numerous small ribs separated by hollow blocks or grooves filled with light pumice concrete. The reinforcement is placed in the lower parts of the ribs. (Fig. 6.)

T-BEAMS

If the hollow blocks above described, or the other light filling material, is omitted, the floor construction consists of T-beams of concrete with the steel enclosed by the stems of the T's. If the ribs are arranged further apart, and are built proportionately larger, then what was formerly the compression zone



FIG. 7.

must now be treated, in accordance with established rules, as a restrained reinforced concrete slab between beams.

In this way is developed a construction in which the slabs and beams combine to form a statically effective T-section.

It is also possible to design slabs and independent beams of proper strength and of simple rectangular sections, but it is clear that by making the slabs carry the compressive stresses, a considerable economy is practised. The stressing of the concrete slab in two directions at right angles to each other, is not at all hazardous, and occurs in numerous other types of construction. From a theoretical standpoint, a slab strengthened with ribs is more economical of material than a slab of uniform thickness. At a certain span, the greater cost of installing the ribs equals the saving in material, so that T-beams can first be built economically with spans of between 3 and 4 meters (10 to 13 ft.).

Between the slabs and beams, naturally occur shearing stresses, for the transference of which most builders arrange special vertical reinforcing members called stirrups (Bügel) consisting of 6 to 10 mm. ($\frac{1}{4}$ to $\frac{3}{8}$ in.) round rods, or of thin, flat iron. These enclose the bottom reinforcing rods and thus prevent the formation in the concrete of the ribs, of possible longitudinal cracks

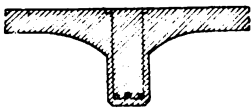

FIG. 8.

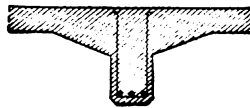

FIG. 9.

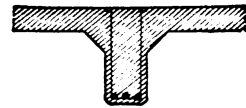

FIG. 10

which might be caused by the hooked ends of the main reinforcing rods. The stirrups thus increase the adhesive strength, so that it equals at least that employed in calculations.

As proved by tests which will be described later, stirrups with none but straight main reinforcing rods have only a small effect on the increase of the shearing strength of the ribs, so that their practical value consists in more securely connecting the slabs and beams, and producing a better distribution of the adhesion.

So as to secure the best transfer of forces from one to the other, the connection between beams and slabs is variously designed, as illustrated in Figs. 8 to 10. By so doing, the advantage is also gained of strengthening the slabs where greatest moments occur. With this design, arched ceilings between reinforced concrete beams are produced. (Fig. 8.)

As with flat slabs, a single low layer of reinforcement is not found satisfactory, especially if there is any restraint at the ends, or, if the beams are continuous,

over several supports. Similarly, at points of negative moment, steel must be introduced near the tops of the T-beams, or by carrying certain rods up and over the supports.

Under certain load conditions, continuous top reinforcement may be necessary, especially with unequal spans. Furthermore, at the simply supported ends of the slabs of heavily-loaded T-beams, some of the lower reinforcement should be bent upwards (at an angle of about 45°) so as to take up the shearing stresses, or rather, the diagonal tensile stresses in the slabs, for which reinforcement must be provided. Since the moments decrease toward the ends of the slabs, not all of the rods are necessary close to the bottom in the vicinity of the supports, so that a part can advantageously be bent upward.

The ribs are usually located underneath the slabs, but there are also cases in which they may be placed above them. One or the other arrangement will be employed, according to circumstances.

Since the moments are partly positive and partly negative for restrained and continuous beams, no special advantages are gained with ribs located above the slabs.

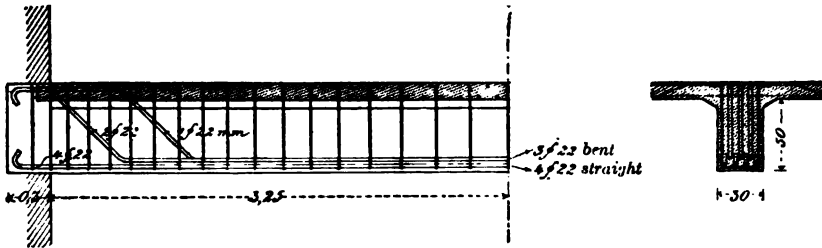

FIG. 11.

At the intermediate supports, where the greatest moments are found, the compression occurs along the lower edge of the beam. In order to lessen the unit stress, the beam section is increased at such points by means of a bracket or knee, producing a slightly arched effect. In cases where the ribs are located above the slabs it is possible to do without these knees, since the whole width of the slab between ribs serves as a zone of compression.

The knees or brackets at the intermediate supports have the added advantage of considerably reducing the unit shearing stresses, partly because of the increased depth of beam, but principally because the compressive stresses along the lower edges of the beam at such points act obliquely upward and thus equilibrate a part of the diagonal forces. (See Fig. 13.)

Figs. 11 and 12 respectively, illustrate advantageous arrangements of reinforcing rods for a simply supported and a continuous T-beam. Bending the rods upward at the intermediate support, and anchoring them in the adjoining beam brings about an economy in their use in resisting the regular distribution of moments; and furthermore, this bent form increases the resistance of the stem of the T-beam against shearing forces. Viewed in this light, it is evidently to be recommended (with reference to better anchorage in the concrete of the ribs), that some at least of the upper steel which terminates near the

intermediate supports should be bent obliquely downward, as shown in Fig. 14. In that figure is also shown how the knees may be reinforced so as to increase their compressive strength.

If the stem of the T-beam does not afford enough room to allow all the reinforcing rods to be placed side by side, they may be arranged in layers, in which case it is possible to place the bent rods on top, as shown in Fig. 11. This should be done only in case of necessity, since the rods are more effective statically when closer together than when they are arranged in two or more

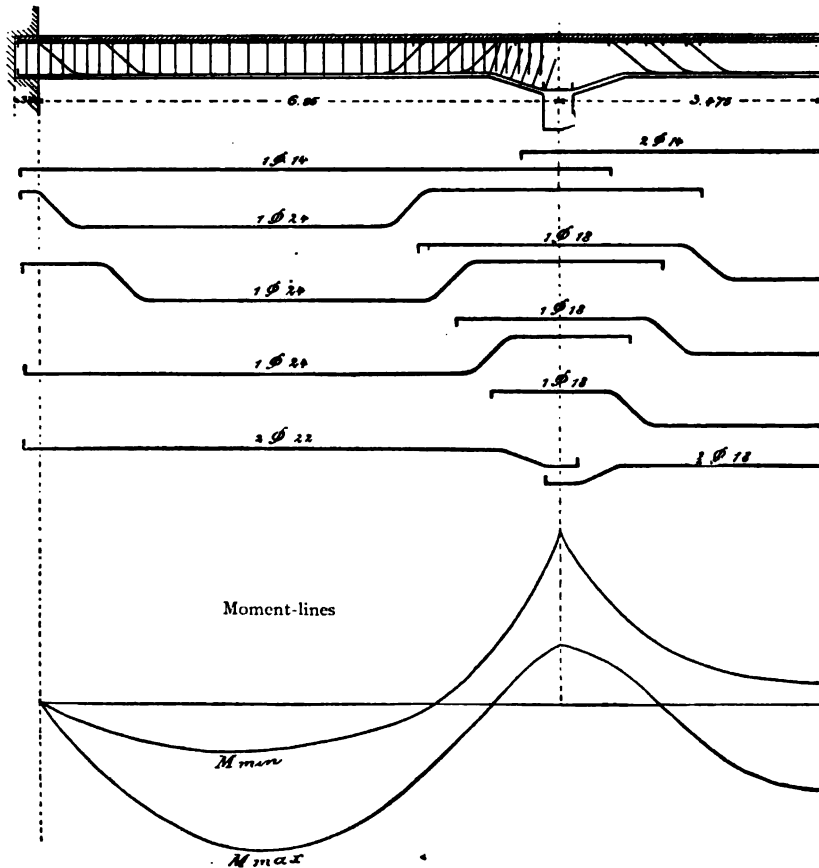

FIG. 12.—Reinforcement and moment lines for continuous beams of three spans.

layers, because their centroid is then lower. With continuous beams over spans of varying lengths, if a long span is fully loaded it may be necessary to provide continuous top reinforcement in the adjacent shorter spans. The amount of restraint afforded continuous beams by intermediate reinforced concrete supports or partition walls, is comparatively small and may well be neglected. The same is even truer in the case of the end supports, since positive restraint will occur only in the rarest instances, where special means have been adopted to provide it.

At simply supported ends of T-beams care should be taken to run some of

the lower rods straight over the supports. The required number is to be determined by the necessary adhesion.

With large spans the standard lengths of rods will not suffice, so that welding will be necessary. The weld should be located where the rod is not fully loaded, which, in general, is in a bend.

If a room of given dimensions is to be floored, it is first divided into panels by main girders, with intermediate supports if necessary. These girders are then connected by simple slabs, or beams may be introduced between the girders so as to diminish the slab spans. In that case the slabs are supported on all four sides, and require a correspondingly light reinforcement, especially in a direction parallel with their greatest dimension. The principal reinforcement is placed in the opposite direction, or perpendicular to the beams.

When both girders and beams are employed, and the slabs are used as flanges of the girders, these slabs will be thrown into compression and their

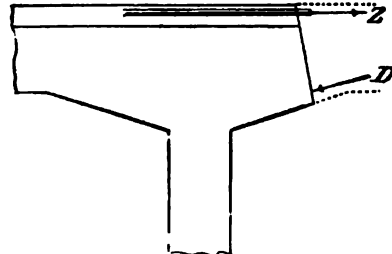

FIG. 13.

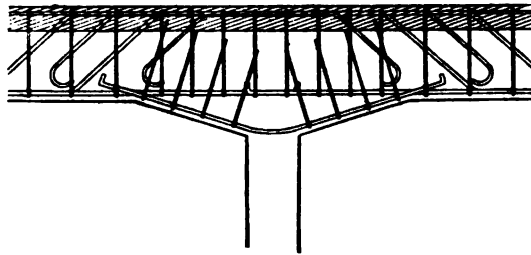

FIG. 14.—Reinforcement for an intermediate support of a continuous beam.

stress must be added to their proper stresses from bending. For that reason it is recommended that only small widths of slabs be used in computing girders, and that the slabs be constructed with haunches, where slabs and girders meet.

COLUMNS

In columns, several varieties are to be distinguished. Some are reinforced with vertical round rods, others with rolled shapes which are made into rigid frames, and since 1902 the spiral reinforcement invented and patented by Considère has been employed. Further, in the first two varieties, the horizontal connections between the vertical pieces are of special importance in connection with the strength of the column. Instead of temporary wooden forms, reinforced cylinders or cement blocks can also be used, the latter being especially applicable to bridge piers. In building work, the concrete columns take the place of cast or wrought iron ones, and must be as small in diameter as possible. Consequently, the use of a permanent shell is out of the question.

By the term "reinforced-concrete column" is usually understood one containing vertical round rods. Such a column is constructed in the following way:

A concrete column of any section contains a certain number of vertical rods which are placed close to the surface. At certain points the rods are fastened

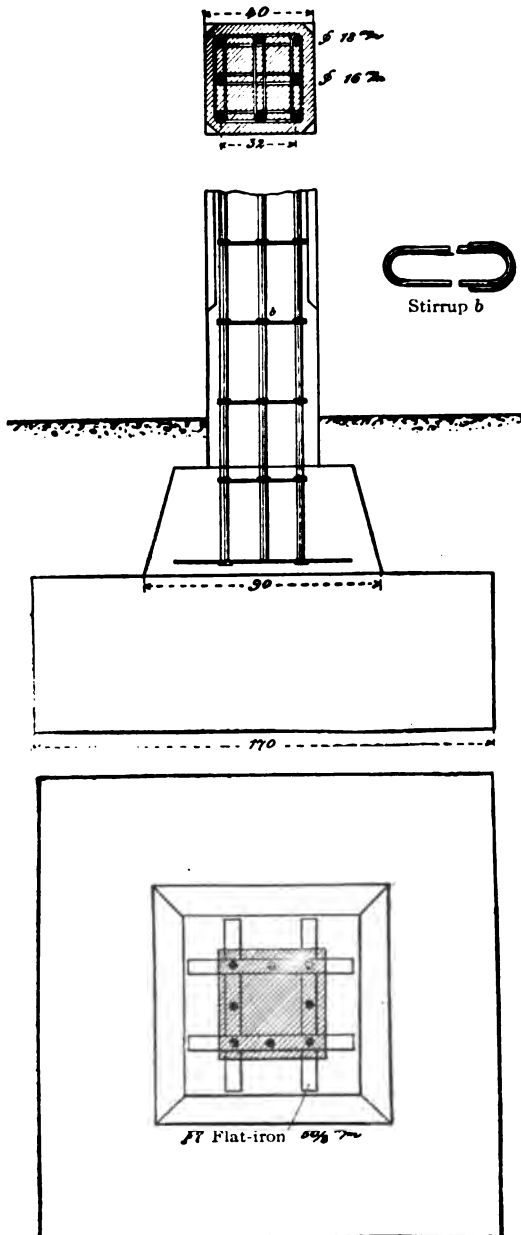

FIG. 15.—Base and section of a reinforced concrete column.

together with horizontal wire ties. The whole reinforcement thus forms a skeleton, which encloses the concrete and prevents lateral bulging. The result is that even in long columns, ignoring the necessary safety against bending, the strength of plain cubes will be attained. The latter is higher than that of prisms. The ties are placed from 20 to 40 cm. (8 to 16 ins.) apart.

For a square column, the reinforcement usually consists of four rods located in the corners, with ties of 7 to 8 mm. (approximately $\frac{1}{4}$ to $\frac{3}{16}$ in.) wire. With large dimensions, eight rods are used. (See Figs. 15 and 16.)

The lower ends of the vertical reinforcing rods rest on a grid of flat bars, so that the load carried by the rods may be distributed over a larger area of concrete. This grid is usually placed in a separate concrete pedestal, which distributes the column load over a larger surface of the foundation concrete proper, corresponding with the lesser allowable unit stress of the latter. In columns which extend through several stories of a building, the sections diminish upward, and the rods have to be offset at each change of diameter. Further, rods have to be spliced, which can be

done simply by slipping a short piece of pipe over the blunt ends. (Fig. 17.)

Greater resistance against bending is afforded, however, by lapping the

vertical rods from 50 to 80 cm. (20 to 30 ins. approximately) and by having their ends hooked. (See Fig. 18.)

Naturally, the column section may be rectangular, hexagonal, octagonal, circular, etc., and the number of reinforcing rods can be increased in proportion to the load. With eccentric loading, they should all be placed on one side. The interiors of columns can also be made hollow by enclosing pipes in the concrete. These can serve for rain leaders, or may contain gas or water mains.

The diameter changes to correspond with the load to be carried, and with the factor of safety desired. It may run from 20 by 20 cm. (8 by 8 ins.) to 70 by 70 cm. and more (28 by 28 ins.). The diameter of the rods may vary from 14 to 40 mm. ($\frac{1}{2}$ in. to $1\frac{1}{2}$ ins. approximately).

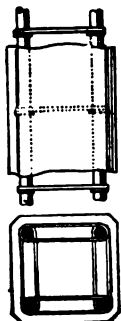

FIG. 16.



FIG. 17.

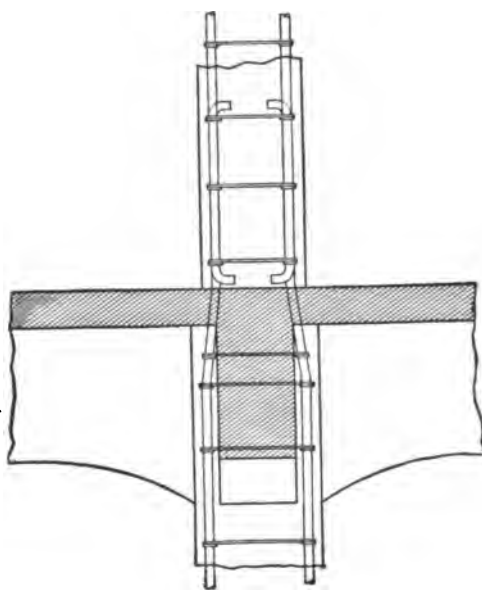

FIG. 18.

Splicing of rods in concrete columns.

Columns of spirally reinforced concrete designed by Considère have relatively light-strength longitudinal rods, while the greater part of the load is carried by a spiral wrapping which encloses the longitudinal rods and the concrete core within them. This spiral affords great resistance against the bulging of the concrete under load. The spirals should be covered by concrete, so that the best shape for such a column is round, octagonal, or hexagonal. The first publication by Considère concerning his "béton fretté," or hooped concrete, was in "Génie Civil," in November, 1902. His investigations on concrete cylinders with spiral reinforcement disclosed an efficiency 2.4 times greater for the reinforcing material than when used simply as straight rods, and the strength of the concrete was increased to 800 kg/cm^2 ($11,400 \text{ lbs/in}^2$), or about quadrupled. Practical applications are already quite numerous and are especially useful in cases where it is necessary that a very heavily loaded column should have a small diameter.

ARCHES

The reinforcement for small arches can be determined in the same manner as for simple slabs. Since no bending moments act on an arch with a parabolic profile and uniform loading, a system of lightly interwoven reinforcement near the soffit is usually sufficient. Usually, however, such simple reinforcement is not enough, a second layer near the upper surface extending from the abutments over the haunches being needed. In bridge arches which are subjected to variations of load, reinforcement is introduced throughout near both the upper and lower arch surfaces.

Reinforced concrete arches have the advantage over arches of plain concrete that the reinforced arch can withstand tensile stresses as well as compressive ones. For short spans it is thus possible to secure reinforced arches, which make full use of the compressive strength of the concrete. Under such conditions, arches of much less thickness are secured than when non-reinforced concrete is used, the thickness of which for short spans must be made so great as to prevent the appearance of appreciable tensile stresses.

In arches of larger span, properly designed to meet the conditions involved, tensile stresses do not occur, and the question of reinforcement lessens in importance since it does not change the unit compressive stresses enough to compensate for its employment. With wide spans, the profile of the arch is of considerable importance, so that the unit compressive strength of the concrete shall not be exceeded; while, with short spans, and with the introduction of reinforcement, the form of the arch can be freely chosen within certain limits. Cases often occur in building work where the form of an arch must be selected for architectural reasons not corresponding at all with the statical conditions, and only a reinforced arch can be employed.

Just as in slabs, so in arches—lateral reinforcement is employed, which serves the same purpose as the distributing rods in slabs, and is similarly designated. The upper and lower systems of reinforcement in arches are held in the desired relative positions by means of wire ties.

Besides round rods, rolled shapes are sometimes used in arches (Melan system). Then the arch is composed of a series of parallel ribs which are entirely embedded in concrete. In floor arches and other small structures, the ribs are T-bars, rails or wide-flanged I-beams, and are connected with each other only at the points of support. With larger spans and deeper ribs, the latter are built as lattice girders, and bars are run between them. These serve mainly as supports for the arch forms.

PART I

CHAPTER II

THEORY OF REINFORCED CONCRETE

STRENGTH AND ELASTICITY

IN the early stages of the development of reinforced concrete, its builders had at hand no recognized methods of calculation, and Monier and François Coignet erected their work solely by practical instinct and experience. Of late, a real rivalry has developed in the production of new theories concerning reinforced concrete, and their authors have been anxious to explain the particular excellence inherent in a combination of steel and concrete, with reference to their combined statical action. Practice has here been far ahead of theory. The principal question in controversy has been whether the tensile strength of the concrete in bending should be considered. Among practical builders this question was really decided at the start, and decided against its inclusion, because absolutely no attention is paid to it and the steel is stressed to the maximum safe limit. The tensile strength of the concrete is entirely ignored. On this assumption was based the first method of theoretical computation of slabs, devised by Koenen (Government architect) in Berlin in 1886, and his method has been used by the majority ever since.

Theoretical investigators, unfamiliar with the practical side of concrete construction, usually considered the tensile strength of the concrete, and some even went so far in the older methods as to assume the elasticity in tension and compression as equal. Later, the modulus of elasticity in tension was accepted as smaller than that for compression, and a parabola was assumed as the stress-strain curve. Finally, the stress curve for concrete in tension was found by Considère's investigations to be a straight line parallel with that of the steel. It is evident that with such assumptions, results are obtainable which appear extremely accurate to the several authors; but long formulas are not attractive to practical builders, and in this connection it is to be observed that the employment of a parabola for the stress-strain curve is actually less accurate than the use of a straight line, because a certain amount of violence must be used if the stress-strain curve is forced into parabolic form. But, ignoring this point, such methods of calculation do not provide the desired degree of safety, and may even become actually dangerous if too small a percentage of reinforcement is used.

It is not the object of this book to give a review of all proposed methods of calculation. This would be useless, and furthermore, the methods of checking designs contained in the "Vorläufige Leitsätze für Eisenbetonbauten" (Tentative

Recommendations concerning Reinforced Concrete Construction) published in 1904 by the Verband Deutscher Architekten- und Ingenieurverein and the Deutscher Beton-Verein, and in the "Bestimmungen für die Ausführung von Konstruktionen aus Eisenbeton bei Hochbauten" (Regulations for the Execution of Constructions in Reinforced Concrete in General Building Work), issued by the Prussian government, are identical with those contained in the first edition of this book (1902). The new requirements of the French Ministry of Public Works of October 20, 1906, for posts and telegraphs, also contain the same assumptions and methods of computation. Therefore, here will be discussed only the theory above described, which has been proved best by several years of trial and in a large number of constructions. Since the first edition, the results of numerous experiments have been secured which test the accuracy of these methods of calculation and especially explain the importance of shear in T-beams.

Methods of calculation will therefore be found in close connection with the results of experiments. In no other subject is it more important to rely as completely on the results of tests, if disagreeable experiences are to be avoided, since the present knowledge concerning reinforced concrete is at best imperfect and liable to surprises. Before turning to the methods of calculation, which are very simple, a review will be made of the strength and elastic properties of steel and plain concrete, so that the formulas may be more susceptible of daily use.

STEEL (EISEN)

The properties of steel (wrought iron or steel) are well known to-day. In calculations relative to steel construction, the relation between stresses and strains is assumed, and the limiting ratio will never be exceeded in actual loading. Furthermore, the tensile strength is the same as the compressive strength,

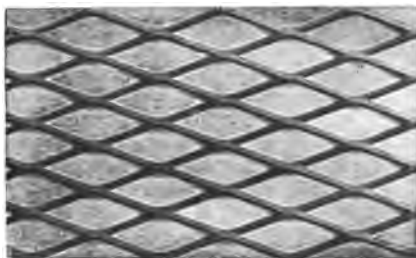

FIG. 19.

and the elastic behavior is the same under tensile and compressive stresses. As to the modulus of elasticity and the safe working stress, opinions do not differ materially. Usually, wrought iron in the form of rods is employed* for reinforcement. In Table I some results are given for ordinary material from stock. In it, d represents the diameter of the machined test specimen, not of the rod from which the specimen was prepared.

In special locations, such as arch bridges, the steel reinforcement can be

* In Europe.—TRANS.

used in the form of rolled shapes or of lattice girders. The American expanded metal (Fig. 19) invented by Golding, made by stamping and bending sheet metal, has been highly recommended for the reinforcement of slabs. Any required strength can be obtained by change of thickness, and size of mesh. However, when using expanded metal one does not have as easy a means of adapting the design to the variation of the moments, as with the use of round rods, so that expanded metal can be used only for simple slabs. The lighter grades are used for ornamental plaster beams of various kinds. In stamping the meshes from the sheet, the material experiences a heavy stress, and, since the strength and ability of ingot iron to stretch are damaged by stamping, the sheets must be annealed in order to remove this defect.

TABLE I

RESULTS OF TESTS ON ROUND IRON MADE BY THE TESTING LABORATORY OF THE ROYAL TECHNICAL HIGH SCHOOL, STUTTGART

| Diameter | | Elastic Limit | | Tensile Strength | | Modulus of Elasticity | | Stretch in Length of rod | Reduction in Area |
|----------|------|--------------------|-----------------------|--------------------|-----------------------|-----------------------|-----------------------|--------------------------|-------------------|
| mm. | in. | kg/cm ² | lbs./in. ² | kg/cm ² | lbs./in. ² | kg/cm ² | lbs./in. ² | % | % |
| 10 | 0.39 | 2994 | 42590 | 4178 | 59430 | 2192000 | 31180000 | — | — |
| 10 | 0.39 | 3026 | 43040 | 4182 | 59480 | 2143000 | 30480000 | 26.4 | 66.9 |
| 10 | 0.39 | 3104 | 44150 | 4123 | 58640 | 2140000 | 30440000 | 27.0 | 69.1 |
| 10 | 0.39 | 3117 | 44330 | 4234 | 60220 | 2172000 | 30890000 | 24.8 | 66.9 |
| 10 | 0.39 | 3038 | 43210 | 4329 | 61570 | — | — | — | 71.0 |
| 15 | 0.59 | 2710 | 38550 | 3810 | 54190 | 2116000 | 30100000 | 27.2 | 55.3 |
| 15 | 0.59 | 2725 | 38760 | 4146 | 58970 | 2150000 | 30580000 | 30.0 | 71.7 |
| 15 | 0.59 | 2627 | 37370 | 3870 | 55050 | 2140000 | 30440000 | 26.4 | 55.6 |
| 15 | 0.59 | 2938 | 41790 | 4124 | 58660 | 2133000 | 30340000 | 28.0 | 71.6 |
| 15 | 0.59 | 3277 | 46610 | 4610 | 65570 | — | — | 30.0 | 53.7 |
| 20 | 0.79 | 2650 | 37690 | 3940 | 56020 | 2184000 | 31060000 | 30.3 | 64.4 |
| 20 | 0.79 | 2166 | 30810 | 3790 | 53910 | 2165000 | 30790000 | 31.2 | 64.0 |
| 20 | 0.79 | 2681 | 38130 | 3991 | 56760 | 2161000 | 30740000 | 30.4 | 64.4 |
| 20 | 0.79 | 2627 | 37360 | 3845 | 54690 | 2177000 | 30960000 | 31.2 | 63.6 |

In America various forms of reinforcement are employed, all of which are designed to prevent slipping of the rod in the concrete. In the Ransome rod (Fig. 20), this is secured by twisting the square steel bar; in the Johnson bar,

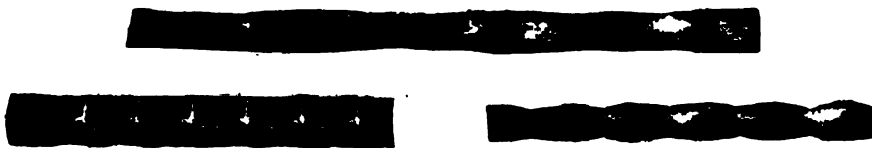

FIG. 20.

elevations on the surfaces of the rods are produced in the rolling; and the Thatcher or knotted bar is provided with swellings, while maintaining a constant sectional area. These "knots" may well have the desired effect when

the rod is anchored in a large mass of concrete, but they will act in an opposite manner in the small stems of T-beams, especially at their bottoms, where they will have a splitting effect and thus cause premature failure of bond. It will be shown later that the adhesion in the case of ordinary round rods with hooked ends is ample to transfer all actual stresses, and furthermore, the arrangement of the principal reinforcement may be so designed with respect to the shearing stresses that no occasion should arise to make up any deficiency through the use of those costly special bars.

CONCRETE

For reinforced concrete work only rich mixtures of fine-grained materials should be employed. Practically, only with rich, wet concrete, will the necessary adhesion and rust prevention be secured, because only then will the tamping force enough grout against the reinforcement to completely coat it. This coating of grout adheres to the concrete in spite of cracks and even rupture between the concrete and the steel, and forms the real rust preventative, as can be demonstrated. When using drier and poorer concrete, it is important to coat the reinforcement with cement grout immediately before depositing the concrete.

The sand aggregate exerts a great effect in determining the quality of the concrete. With the cement it forms the mortar, and on the strength of this mortar depends the strength of the concrete. The strength of the latter is usually somewhat greater than when no gravel is used. In the "Mitteilungen über Druckelastizität und Druckfestigkeit von Betonkörpern mit Verschiedenem Wasserzusatz" (Communication Concerning the Compressive Strength and Elasticity of Concrete Specimens with Different Admixtures of Water), Stuttgart, 1906, pages 11 and 14, the following figures are given, which are of interest in this connection:

The compressive strength of mortar taken from a 1:2½:5 mixture, amounted, in

| 28 days | 100 days |
|---|---|
| to 294 kg/cm ² (4182 lbs/in ²) | 332 kg/cm ² (4722 lbs/in ²), |

while the strength of the corresponding earth-moist concrete of 1:2½:5 mixture was

| | |
|--|---|
| 225 kg/cm ² (3200 lbs/in ²) | 321 kg/cm ² (4566 lbs/in ²). |
|--|---|

Similarly, for a 1:4:8 mixture (pages 10 and 13), the results were

| | |
|---|---|
| Mortar 280 kg/cm ² (3982 lbs/in ²) | 258 kg/cm ² (2670 lbs/in ²). |
| Concrete 230 kg/cm ² (3271 lbs/in ²) | 254 kg/cm ² (2513 lbs/in ²). |

The "Leitsätze" of the Verbandes Deutscher Architekten- und Ingenieurverein recommended that in the composition of concrete for reinforced work, the mortar contain sand of graded sizes of particles up to 7 mm. (0.28 in.), and be mixed not poorer than 1:3. Further, that the addition of gravel or stone chips in

quantities up to that of the sand was permissible. The size of the gravel or stone should be between 7 mm. (0.28 in.) and 25 mm. (0.98 in.).

Of cement, only the best Portland should be used corresponding at least with the "Normen"* since not enough experience has been obtained concerning other cements, especially as to their action on reinforcement.

Under certain conditions, pumice may advantageously be used as the principal aggregate of concrete. On account of its smaller strength, pumice concrete can only be used for light slab construction, principally roofs, where, besides the advantage of its lighter weight, it also has that of insulating against temperature changes. Although pumice-concrete is principally used in arches, between steel beams, it can also be used in the slabs of reinforced floors, provided the beams are made of gravel concrete. Pumice-concrete is usually made with river sand as part of the aggregate.

STRENGTH AND ELASTICITY OF CONCRETE

Compressive Strength.—The resistance which concrete offers to crushing is quite variable, and changes with the proportions of the mixture and with the properties of the sand, gravel, and broken stone, as well as with the tamping during making. The form and size of the test specimen also influences the apparent strength. The compressive strength per square centimeter decreases when the section of the specimen is enlarged. The apparent strength is especially dependant upon the ratio of the height of the specimen to its base. When this ratio is small (as in mortar joints) the strength is considerable. But when the height is several times the diameter of the base, failure will occur along a diagonal plane, because the shearing strength has been exceeded, and the compressive strength, which is not involved, appears small when the breaking load is divided by the area of section. The compressive strength of concrete cubes is called the "cubic strength" (Würfelfestigkeit) of concrete, and is usually assumed as the allowable compressive strength in reinforced work, because in such constructions, diagonal shearing is prevented by the use of proper reinforcement.

As to the increase of strength with age, some very interesting tests are available. They were made in connection with the erection of the bridge over the Danube at Munderkingen. With 1 part cement, 2½ parts sand, and 5 parts pebbles, mixed wet, the test cubes 20 cm. (7.8 in.) on each edge developed the stresses shown in Table II.

TABLE II

LONG TIME COMPRESSIVE STRENGTH TESTS OF CONCRETE

- After 7 days an average compressive strength of 202 kg/cm² (2873 lbs/in²).
- After 28 days an average compressive strength of 254 kg/cm² (3613 lbs/in²).
- After 5 months an average compressive strength of 332 kg/cm² (4722 lbs/in²).
- After 2 years, 8 months an average compressive strength of 520 kg/cm² (7396 lbs/in²).
- After 9 years an average compressive strength of 570 kg/cm² (8107 lbs/in²).

Lately, discussion has turned much to the question of earth-moist or plastic concrete. As plastic concrete is here understood it contains 50 per cent more

* German standard.—TRANS.

water than necessary, so that it can be placed in thicker layers and be brought to a proper consistency by a less number of blows of the tamper than can moist concrete. To solve the problem as to whether moist or plastic concrete was the better, a large number of experiments were made at the Testing Laboratory of the Technical High School of Stuttgart on the compressive strength and elasticity of different proportions. The results of the tests, published by Bach* are of considerable value. Even by these the question is not conclusively answered, since with exactly the same materials the above described specimens, which were made in Ehingen and in Biebrich, gave variously divergent results. While the specimens from Ehingen almost invariably gave substantially higher results for the plastic concrete, the specimens prepared in Biebrich showed a superiority for the moist concrete, but within two years the plastic concrete increased as much in strength as did the moist. The use of the moist concrete requires particularly expert workmanship and rigorous inspection, but even then involves the troubles incident to defective work. On the other hand, a considerable security is obtained with regard to the uniformity of the mass when plastic concrete, that is, such as has an excess of water, is used. In reinforced concrete work, plastic concrete is especially valuable, since tamping is often almost impossible through several layers of reinforcement.

Prismatic specimens, like Fig. 21, on which elasticity tests were made, gave the following compressive strengths, (each result is the average of three observations; mixture, 1 cement to 3 gravel and sand; plastic):

After 3 months, 172 kg/cm² (2446 lbs/in²)

After 2 years, 308 kg/cm² (4381 lbs/in²)

The strength of reinforced concrete buildings, therefore, increases with time, so that one-fifth of the cubic strength at an age of twenty-eight days may well be assumed as the safe working stress. According to the "Leitsätze," under ordinary weather conditions, at an age of twenty-eight days the concrete should develop a compressive strength in 30 cm. (12 ins. approximately) cubes, of 180-200 kg/cm² (2560-2845 lbs/in²). If this strength is not developed with any particular sand when mixed in mortar proportions of 1 to 3, then more cement is to be added. Moreover, the 1:3 mortar mixture is to be considered the extreme limit, especially with regard to the securing of ample protection against rust.

Tensile Strength. The results of tensile tests are more variable than those of compression. All the conditions which affect the apparent compressive strength, affect the tensile strength as well, and the shape and size of the test specimen is of even more importance.

In the majority of cases, tensile tests are made on mortar specimens, that is, on bodies composed only of cement and sand, and are prepared only to afford a test of the cement. Few tests on regular concrete specimens have ever been made. The latter give lower results than do specimens made of mortar, as is

* "Mittelungen über die Herstellung von Betonkörpern mit Verschiedenem Wasserzusatz, sowie über die Druckfestigkeit und Druckelastizität derselben," Stuttgart, 1903. Konrad Wittwer. (Report Concerning the Manufacture of Concrete Specimens with varying Percentages of Water, together with their Compressive Strength and Elasticity.) The second edition (1906) contains the experiments on specimens two years old.

shown by the experiments made in connection with some elasticity tests at the Testing Laboratory in Stuttgart, the specimens for which are illustrated in Fig. 21.

The results contained in Table III are averages of three tests of specimens made of Heidelberg cement and Rhine sand and gravel, mixed wet:

TABLE III
TENSILE STRENGTH OF CONCRETE

| Mixture | Age | Tensile Strength |
|---------|----------|--|
| 1:3 | 3 months | 12.6 kg/cm ² (179 lbs/in ²) |
| 1:3 | 2 years | 15.5 kg/cm ² (220 lbs/in ²) |
| 1:4 | 3 months | 9.2 kg/cm ² (130 lbs/in ²) |

Even on similar specimens the results are quite variable, as is shown by the fact that the number 15.5 is the average of 8.8, 15.8, and 22.0.

Elasticity of Concrete.—Just as it is impossible to assign a definite value to the breaking strength, so it is impossible to do so for the modulus of elasticity of concrete, since all the above mentioned points influence the elasticity as well as the strength. For this reason the results obtained by different observers cannot be compared, and therefore it is necessary to make special tests in practical cases or to select results made under comparable conditions.

Experiments concerning the elastic deformation of Portland cement concrete under pressure have been made by Durand-Claye,* by Bauschinger, and by the committee on arches of the Oesterr. Ingenieur- und Architektenverein, etc.; but the most accurate and best known are those made by Bach.

All former tests were defective in that they employed specimens of too small dimensions. Further, no distinction was made between elastic and permanent deformations.

This point was first brought out by Bach in his experiments for the Württ. Ministerialabteilung für Strassen und Wasserbau, in 1895.† His cylindrical specimens were 25 cm. (9.8 in.) in diameter, and 1 meter (39.4 in.) long. The shortening in a length of 75 cm. (29.5 ins.) was measured at two diametrically opposite points. The experiments were conducted as follows:

A load corresponding to 8 kg/cm² (113.8 lbs/in²) was brought to bear on the specimen and then removed. This operation was repeated several times, until only pure elastic deformation resulted. The load was then increased to 16 kg/cm² (226.6 lbs/in²), and the same process of loading and unloading repeated until the maximum permanent set for this load had been attained. In this manner the operation was continued, and with each increment the total deformation, elastic deformation, and permanent set were measured. Curves were drawn to represent the values thus obtained. A definite elastic limit was not disclosed by these curves; rather, from the start the shortening seemed to increase with the stress.

In specimens made with Blaubeurer cement, a straight line can be substituted for the stress-strain curve up to stresses of about 40 kg/cm² (569 lbs/in²).

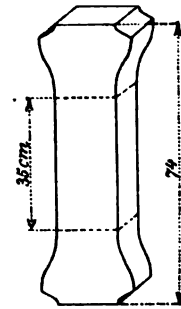

FIG. 21.

* Annales des ponts et chaussées, 1888.

† Zeitschrift des Vereins Deutscher Ingenieure, 1895-1897.

The deformation curves found by Bach are so regular that they may be represented by an exponential equation, the relation between the compression and the stress being such that

$$E = \alpha \sigma^m$$

where E is the deformation in unit length, σ the corresponding stress, and α and m are coefficients which depend upon the properties of the material. Similar relations have been deduced for sandstone, granite, cast iron, etc., for all materials in which no constant proportionality exists between the stresses and the strains, and in which the tensile and compressive elasticities differ considerably.

The equations of Table IV* have been deduced for several different mixtures, but they are not correct for all brands of cement:

TABLE IV

EXPONENTIAL EQUATIONS OF STRESS-STRAIN CURVE OF CONCRETE

| | | |
|------------------------------|--|---|
| 1 cement: 2½ sand: 5 gravel, | $E = \frac{1}{298000} \sigma^{1.14}$, | $\left(\frac{1}{5676100}\right)$ coefficient for inches and lbs.) |
| 1 cement: 2½ sand: 5 stone, | $E = \frac{1}{457000} \sigma^{1.16}$, | $\left(\frac{1}{9190500}\right)$ coefficient for inches and lbs.) |
| 1 cement: 3 sand, | $E = \frac{1}{315000} \sigma^{1.15}$, | $\left(\frac{1}{6520300}\right)$ coefficient for inches and lbs.) |
| 1 cement: 1½ sand, | $E = \frac{1}{356000} \sigma^{1.11}$, | $\left(\frac{1}{7567200}\right)$ coefficient for inches and lbs.) |

Considerable information concerning the compressive elasticity of much tamped concrete of different mixtures and degrees of humidity is to be found in the above mentioned "Mittelungen über die Herstellung von Betonkörper," etc., of Bach, 1903 and 1906.

The dearth of elastic tests on such concrete as is used in reinforced construction work, and the comparatively few tests which had been made on the elasticity of concrete in tension for the arch committee of the Osterr. Ingen- und Arch.-Verein, by Grut and Nielsen, led to the making of some further tests on the elasticity of concrete in compression and tension, at the Testing Laboratory of the Royal Technical High School of Stuttgart.

Specimens like those illustrated in Fig. 21, were made of Mannheimer Portland cement and Rhine sand and gravel. The aggregate consisted of about 3 parts sand of 0 to 5 mm. (0 to 0.2 in.) grains, and 2 parts of gravel of 5 to 20 mm. (0.2 to 0.78 in.) pebbles.

The results are shown graphically in Figs. 22 to 25 inclusive, and are also given in Tables V to VII. The numbers are always the averages of three tests. Six specimens were prepared of each of the mixtures, 1:3, 1:4, and 1:7, with 8 per cent and 14 per cent of water, one-half being tested in compression and the other half in tension. The measured length was 350 mm. (13.8 ins.). The repetition of load was omitted, so that the experiments would not take so long and be so tedious, and to produce an equivalent result at each step, the load was maintained for three minutes. The age of the specimens was quite uniform, viz., 80 to 90 days. Consideration is here given only to the 1:3 and 1:4 mixtures, because the results obtained from the 1:7 mixture were of less value compared with the other two, and because such proportions are not used for reinforced concrete.

* In metric units.—TRANS.

ELASTICITY TESTS OF CONCRETE

TABLE V
1:3 MIXTURE

| Unit Stress | | 8% Water | | | 14% Water | | | | |
|---------------------------|-----------------------------|---------------------------|--------|----------------------------------|---------------------------|--------|---------|----------------------------------|--|
| Metric Kg/cm ² | English lbs/in ² | Deformation in Millionths | E | | Deformation in Millionths | E | | | |
| | | | Metric | English | | Metric | English | | |
| Compression | 61.3 | 871.9 | 255 | 240000 | 3413000 | 293 | 209000 | 2973000 | |
| | 49.0 | 697.0 | 198 | 247000 | 3513000 | 227 | 216000 | 3072000 | |
| | 36.8 | 523.4 | 143 | 257000 | 3655000 | 165 | 222000 | 3158000 | |
| | 30.6 | 435.2 | 117 | 261000 | 3712000 | 135 | 227000 | 3226000 | |
| | 24.5 | 348.5 | 92 | 266000 | 3783000 | 104 | 235000 | 3342000 | |
| | 18.3 | 260.3 | 67 | 273000 | 3883000 | 76 | 241000 | 3428000 | |
| | 15.3 | 217.6 | 55 | 278000 | 3954000 | 62 | 246000 | 3499000 | |
| | 12.2 | 173.5 | 43 | 284000 | 4039000 | 48 | 254000 | 3613000 | |
| | 9.2 | 130.8 | 32 | 287000 | 4082000 | 36 | 260000 | 3698000 | |
| | 6.1 | 86.8 | 21 | 290000 | 4125000 | 23 | 265000 | 3769000 | |
| | 3.0 | 42.7 | 10 | 300000 | 4267000 | 11 | 272000 | 3869000 | |
| 0 | 0 | | | | | | | | |
| Tension | 1.6 | 22.8 | 6 | 267000 | 3798000 | 7 | 230000 | 3271000 | |
| | 3.1 | 44.0 | 13 | 238000 | 3385000 | 15 | 207000 | 2954000 | |
| | 4.6 | 65.4 | 20 | 230000 | 3271000 | 23 | 200000 | 2845000 | |
| | 6.2 | 88.1 | 28 | 221000 | 3143000 | 32 | 194000 | 2759000 | |
| | 7.7 | 109.4 | 38 | 203000 | 2887000 | 44 | 175000 | 2489000 | |
| | 9.2 | 130.8 | 47 | 196000 | 2788000 | | | | |
| | | | | Tensile Strength 12.6 (179.2) | | | | Tensile Strength 10.5 (149.3) | |

TABLE VI
1:4 MIXTURE.

| Unit Stress | | 8% Water | | | 14% Water | | | | |
|-------------|---------|---------------------------|--------|---------------------------------|---------------------------|--------|---------|---------------------------------|--|
| Metric | English | Deformation in Millionths | E | | Deformation in Millionths | E | | | |
| | | | Metric | English | | Metric | English | | |
| Compression | 61.3 | 871.9 | 290 | 211000 | 3001000 | 360 | 170000 | 2418000 | |
| | 49.0 | 697.0 | 225 | 218000 | 3101000 | 276 | 177000 | 2518000 | |
| | 36.7 | 522.0 | 163 | 225000 | 3200000 | 198 | 185000 | 2631000 | |
| | 30.6 | 435.2 | 133 | 230000 | 3271000 | 160 | 191000 | 2716000 | |
| | 24.5 | 348.5 | 104 | 235000 | 3342000 | 124 | 198000 | 2816000 | |
| | 18.3 | 260.3 | 76 | 241000 | 3428000 | 90 | 203000 | 2887000 | |
| | 15.3 | 217.6 | 62 | 247000 | 3513000 | 73 | 210000 | 2987000 | |
| | 12.2 | 173.5 | 49 | 250000 | 3556000 | 58 | 215000 | 3058000 | |
| | 9.2 | 130.8 | 36 | 257000 | 3655000 | 42 | 219000 | 3115000 | |
| | 6.1 | 86.8 | 23 | 265000 | 3769000 | 27 | 226000 | 3214000 | |
| | 3.0 | 42.7 | 11 | 273000 | 3883000 | 12 | 250000 | 3556000 | |
| 0 | 0 | | | | | | | | |
| Tension | 1.6 | 22.8 | 6 | 266000 | 3783000 | 6 | 250000 | 3556000 | |
| | 3.1 | 44.1 | 13 | 240000 | 3414000 | 14 | 221000 | 3143000 | |
| | 4.6 | 65.4 | 21 | 224000 | 3186000 | 22 | 200000 | 2845000 | |
| | 6.2 | 88.2 | 31 | 200000 | 2845000 | 32 | 194000 | 2759000 | |
| | 7.8 | 110.9 | 41 | 190000 | 2702000 | | | | |
| | | | | Tensile Strength 9.2 (130.8) | | | | Tensile Strength 8.8 (125.2) | |

When deformations are taken as ordinates and stresses as abscissas, the curves of Figs. 22 to 25 are obtained:

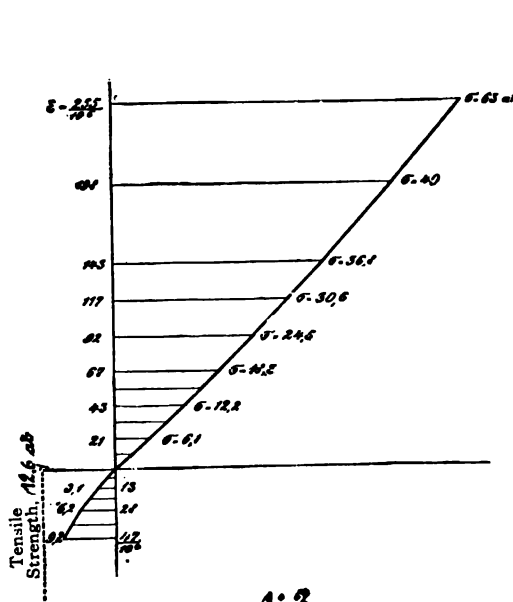

1:3
8% water

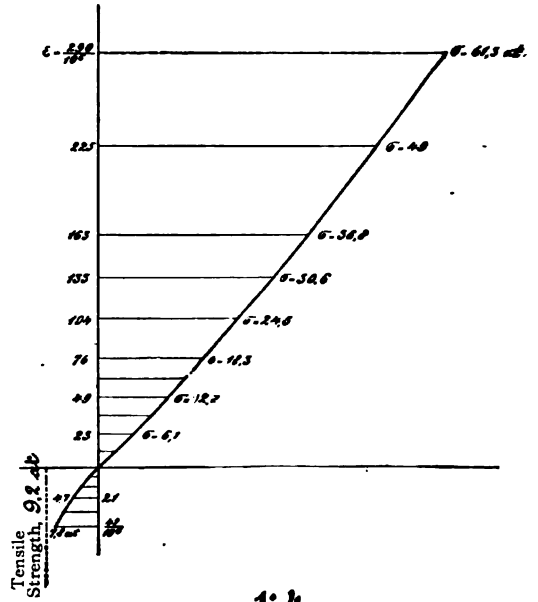

1:4
8% water

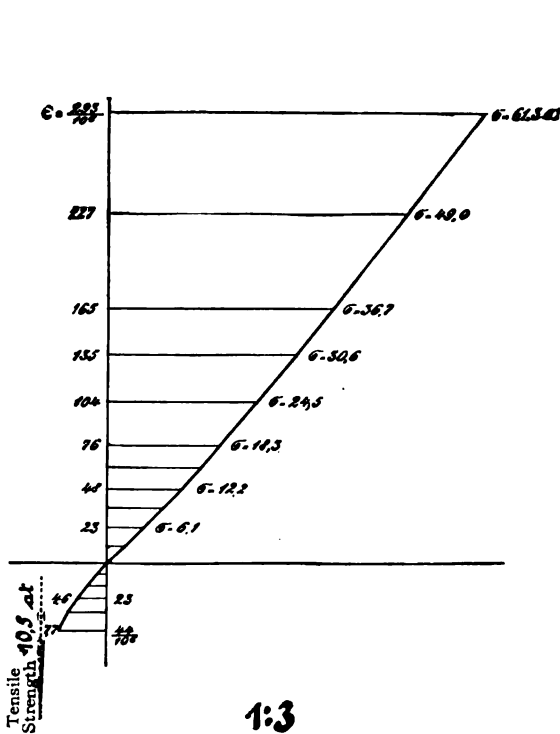

1:3
14% water

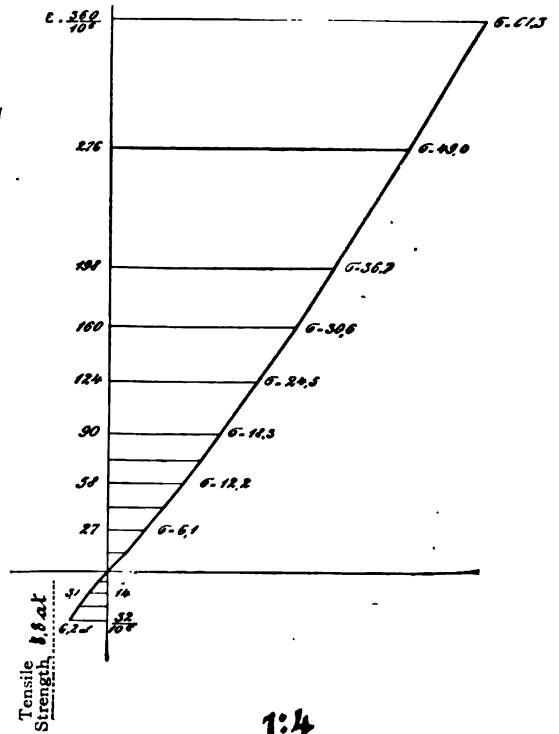

1:4
14% water

FIGS. 22-25.—Stress-strain curves for concrete.

The deformation curves are quite regular in shape. The tensile strength of large concrete specimens is always considerably less than of octagonal mortar ones, since the latter can be compacted much better than can larger ones. Concerning the percentage of water used, it is to be noted that the specimens were molded in water-tight cast-iron forms; that the sand and gravel was not absolutely dry, and that the addition of 14 per cent of water (especially with the poorer mixtures) proved superabundant—a condition not reached in practice even with plastic concrete. Measurements of deformations cannot be carried as near to the ultimate strength as is to be desired, because of the danger of damaging the measuring instruments.

Just as the ultimate strength of concrete increases with age, so does the modulus of elasticity. This can be seen from the experimental results of Table VII obtained on specimens two years old mixed 1:3, with 14 per cent of water. The results of tests on three-month old specimens are also given for comparison.

TABLE VII
ELASTICITY TESTS OF OLD CONCRETE

| Unit Stress | | Three Months Old | | | Two Years Old | | | Remarks | |
|--------------------|---------------------|-----------------------------------|--------|---------|-----------------------------------|--------|---------|-------------------------|---------|
| Kg/cm ² | lbs/in ² | Deformation in Millionths | E | | Deformation in Millionths | E | | | |
| | | | Metric | English | | Metric | English | | |
| Compression | 86.0 | 1223.1 | | | 334 | 257000 | 3655000 | Average of three tests. | |
| | 73.7 | 1048.2 | | | 280 | 263000 | 3741000 | | |
| | 61.3 | 871.9 | 293 | 209000 | 2973000 | 229 | 268000 | | 3812000 |
| | 49.0 | 697.0 | 227 | 216000 | 3072000 | 180 | 272000 | | 3869000 |
| | 36.8 | 523.4 | 165 | 222000 | 3158000 | 132 | 278000 | | 3954000 |
| | 30.6 | 435.2 | 135 | 227000 | 3229000 | 109 | 280000 | | 3983000 |
| | 24.5 | 348.5 | 104 | 235000 | 3342000 | 87 | 283000 | | 4025000 |
| | 18.3 | 260.3 | 76 | 241000 | 3428000 | 64 | 286000 | | 4068000 |
| | 12.2 | 173.5 | 48 | 254000 | 3613000 | 42 | 290000 | | 4125000 |
| | 6.1 | | 23 | 265000 | 3769000 | 20 | 305000 | | 4330000 |
| 0 | 0 | | | | | | | One single test each. | |
| Tension | 1.6 | 22.8 | 7 | 230000 | 3271000 | 4.7 | 340000 | | 4836000 |
| | 3.1 | 44.1 | 15 | 207000 | 2944000 | 9.8 | 316000 | | 4495000 |
| | 4.6 | 65.4 | 23 | 200000 | 2845000 | 14.8 | 311000 | | 4423000 |
| | 6.2 | 88.2 | 32 | 194000 | 2759000 | 20.0 | 310000 | | 4409000 |
| | 7.7 | 109.5 | 44 | 175000 | 2489000 | 25.0 | 308000 | | 4381000 |
| | 9.2 | 130.8 | | | | 30.3 | 303000 | | 4310000 |
| | 10.8 | 153.6 | | | | 35.5 | 303000 | | 4310000 |
| | 12.3 | 174.9 | | | | 40.8 | 301000 | 4281000 | |
| 13.8 | 196.3 | | | | 46.2 | 298000 | 4239000 | | |
| | | Tensile strength. 10.5 (149.3) | | | Tensile strength. 15.8 (224.7) | | | | |

The stress-strain curve for the two-year old concrete is shown in Fig. 26.

Bending Strength of Concrete.—The tensile strength of rectangular concrete beams calculated from actual bending tests carried to rupture, by means of Navier's formula, is always about twice the value obtained from direct tension tests. Several results of bending tests on plain concrete beams will first be given,

and then the theoretical explanation of this seeming contradiction will be discussed.

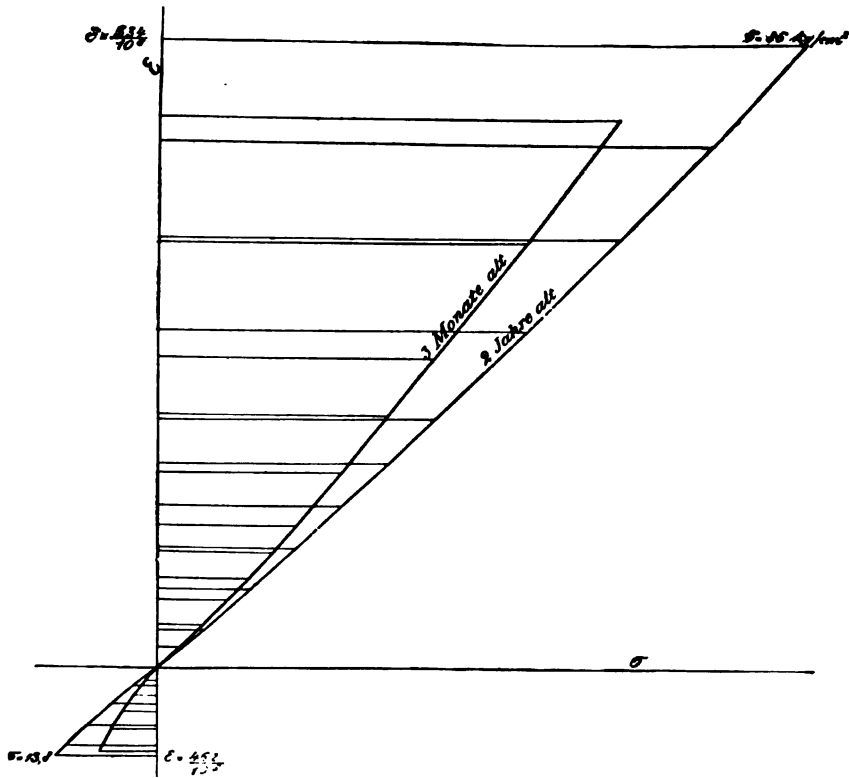

FIG. 26.—Stress-strain curves for concrete 3 months and 2 years old.

EXPERIMENTS BY HANISCH AND SPITZER.

Not only were the bending strengths of the slabs determined, but the tensile and compressive strengths were also ascertained, of specimens carefully cut from the broken slabs. The mixture was $1:3\frac{1}{2}$, the clear span 1.50 meters (59 in.), the width of slab 60 cm. (23.6 in.), and the age 268 days. (See Table VIII.)

The explanation of the seeming contradiction has to be sought in the phenomenon of the variation of the modulus of elasticity and its difference for tension and compression. Consequently, Navier's formula cannot be used except for comparative purposes, the computed extreme tensile stress given by it being too high.

Prof. W. Ritter, of Zurich, has given, in Part I of his "Anwendung der Graphischen Statik," 1888, a graphical method of computing stresses which exceed the elastic limit, applicable to all materials of which the deformation diagram is curved, as is that of cast iron, the relative behavior of which is very similar to that of concrete.

TABLE VIII

COMPARISON OF COMPRESSIVE, TENSILE, AND BENDING STRENGTHS

| No | Thickness | | Concentrated Live Load | | Dead Load | | Compressive Strength | | Tensile Strength | | Bending Strength, $f = \frac{M}{Ibh^2}$ | |
|----------------|-----------|-----|------------------------|------|-----------|-----|----------------------|---------|------------------|---------|---|---------|
| | cm. | in | kg. | lbs. | kg. | bs. | Metric | Engl'h. | Metric | Engl'h. | Metric | Engl'h. |
| 1 | 7.8 | 3.0 | 800 | 1764 | 170 | 375 | 296 | 4210 | 29 | 412 | 54.6 | 777 |
| 2 | 11.5 | 4.5 | 1400 | 3086 | 240 | 529 | 329 | 4680 | 24 | 341 | 43.2 | 614 |
| 3 | 11.5 | 4.5 | 1500 | 3307 | 240 | 529 | 256 | 3641 | 27 | 384 | 46.1 | 656 |
| 4 | 8.0 | 3.1 | 700 | 1543 | 175 | 385 | 314 | 4666 | 23 | 327 | 49.1 | 698 |
| 5 | 10.0 | 3.9 | 1200 | 2644 | 210 | 463 | 352 | 5007 | 20 | 284 | 46.2 | 657 |
| 6 | 10.0 | 3.9 | 1200 | 2644 | 210 | 463 | 300 | 4267 | 29 | 412 | 49.1 | 698 |
| Average. . . . | | | | | | | 308 | 4381 | 25 | 356 | 48.0 | 683 |

The stresses might also be computed with the help of the exponential equation of the stress-strain curve, as was explained by Carling in the Zeitschrift des Oesterreich. Ingenieur- und Architektenverein, 1898. Assuming the elastic properties assigned to granite by Bach, Carling computes, with the help of the exponential law, the location of the neutral axis in a rectangular section, the corresponding maximum tensile and compressive stresses, and the relation between depth of beam and moment for assumed tensile stresses. But since the exponential law applies only to low stresses, it cannot be employed in computations of conditions near rupture.

In the same volume of the above mentioned Zeitschrift, Spitzer gave a method of calculation for beams of materials possessing a variable deformation coefficient, which, while only approximate, is applicable to all beam shapes, and for which a knowledge only of the stress-strain curves for tension and compression is required.

The simplest explanation of the high-bending strengths of concrete is found in the graphical method first above mentioned, which is as follows:

If Navier's hypothesis is assumed, as is here done, in accordance with which plane sections before bending are supposed to remain so after flexure, then the deformations are represented in Fig. 27 by the line DD' and the different stresses by the line EOE' . Since the ordinates are proportional to the deformation, the curve EOE' is none other than the experimentally determined stress-strain curve.

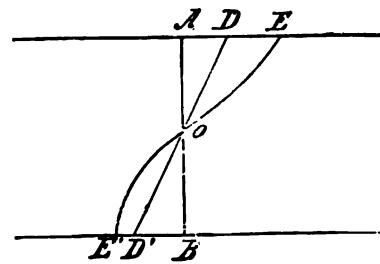

FIG. 27.

Fig. 28 shows this line, which can also be taken to represent the stress-distribution in a beam of rectangular cross-section. The area within the curve above the neutral plane shows the total compressive stress, and the area below it is the tensile stress. Since no external horizontal forces act on the beam, in

every section the total compression must equal the total tension. That means that the areas OAB and OCD , above and below the neutral axis, must be equal. Abscissas above and below, which intersect the deformation curve so as to produce equal areas, therefore indicate corresponding maximum tensile and compressive stresses. Each compressive stress corresponds with a perfectly definite tensile stress. If S_d and S_z are the centroids of the areas OAB and OCD , then the moment of the internal stresses is equal to $Dy=Zy$, in which y is the dis-

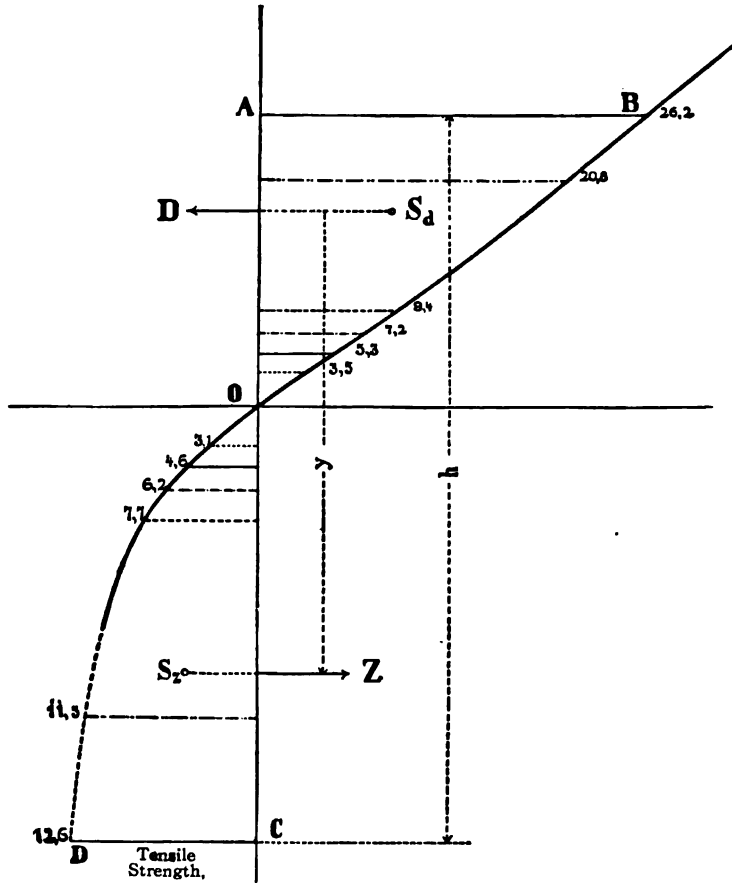

FIG. 28.

tance between the centroids. This moment must be equal to that of the external forces. When a certain edge stress above or below is assumed, the moment can be expressed as a function of h^2 (as is also the case with the exponential law). If the ultimate tensile strength is assumed as the lower edge stress, the maximum possible moment for non-reinforced conditions will be obtained.

If the deformation curve is extended beyond the ultimate tensile stress, as is done in Fig. 28, then are obtained the corresponding edge stresses given in Table IX for the specimens described on page 22 of a 1:3 mixture.

TABLE IX
CORRESPONDING EDGE STRESSES IN CONCRETE BEAMS

| Compression | Tension |
|------------------------|------------------------|
| 3.5 Kg/cm ² | 3.1 Kg/cm ² |
| 5.3 " | 4.6 " |
| 7.2 " | 6.2 " |
| 9.4 " | 7.7 " |
| 20.8 " | 11.5 " |
| 26.2 " | 12.6 " |

Further, there is obtained at the point of rupture, with $\sigma_s=12.6$ and for unit width,

$$D=Z=5.4h;$$

$$y=0.64h$$

$$M'=5.4 \times 0.64 \times h^2 = 3.45h^2 *$$

From this moment, the edge stresses are found by Navier's formula to be

$$\sigma = \frac{M}{W} = \frac{6M}{h^2} = 3.45 \times 6 = 20.7 \text{ kg/cm}^2,$$

whereas the actual stresses are 12.6 on the tension side and 26.2 on the compression side.

Three actual bending tests of the above mentioned mixture gave an average of 21.4 kg/cm² for the bending stress computed by Navier's formula. This is in accord with the value expected from the deformation curve computation. In other words, it may be used as a partial check, since the bending tensile stress shown by it is entirely different from that secured in true tension tests.

Specimens when about three months old were tested to rupture with a center load, and the bending strengths given in Table X were developed according to Navier's formula:

TABLE X*
COMPARISON OF BENDING AND TENSILE STRENGTHS

| Mixture..... | 1:3 | | 1:4 | | 1:7 | |
|-----------------------|------|------|------|------|------|------|
| | 8 | 14 | 8 | 14 | 8 | 14 |
| Bending strength. . . | 21.4 | 23.2 | 16.1 | 16.7 | 13.3 | 12.8 |
| Tensile strength. . . | 12.6 | 10.5 | 9.2 | 8.8 | 4.4 | 5.5 |

The specimens had a length of 1 meter (39.37 in.), a width of 15 cm. (6 ins.), and a height of 20 cm. (7.87 in.). They were mixed with Mannheim Port-land cement and Rhine sand and gravel.

*Metric.—TRANS.

The bending strength of concrete is often used in connection with the compressive strength as a test of the quality of the material, since tests of it are easier to make than tensile ones, which latter depend largely on the degree of accuracy with which the load is applied at the exact center of the specimen. So long as the fact is kept in mind that Navier's formula gives results good only for comparative purposes, and that the actual tensile stresses are only about half those shown by it, that method can conveniently be used.

CHAPTER III
THEORY OF REINFORCED CONCRETE

SHEAR, ADHESION, ETC.

Shearing and Punching Strength of Concrete (Schub- und Scherfestigkeit).—The great importance played by shearing forces in reinforced concrete construction, and a study of the results of other tests, led to the making of the following series of experiments, partly by the writer and partly by the Testing Laboratory of the Royal Technical High School at Stuttgart. The experiments disclosed a marked difference between the qualities of shear and punching resistance ("Schubfestigkeit" and "Scherfestigkeit").

As is known, there exists in every section of a homogeneous beam loaded like those shown in Figs. 29 and 30, normal stresses σ and shearing stresses τ ,

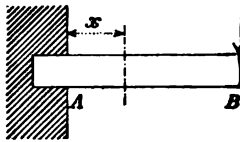

FIG. 29.

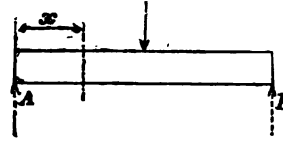

FIG. 30.

which combine to form two inclined mutually perpendicular principal stresses, so-called, viz.:

$$\sigma_I = \frac{\sigma}{2} + \sqrt{\frac{\sigma^2}{4} + \tau^2}$$

and

$$\sigma_{II} = \frac{\sigma}{2} - \sqrt{\frac{\sigma^2}{4} + \tau^2}$$

the directions of which are found from

$$\tan 2\alpha = -\frac{2\tau}{\sigma}$$

If it is understood that between any adjacent sections no external concentrated forces act on the beam, the shearing stresses, which are to be computed according to the formula $\tau = \frac{QS}{Jb}$, occur in pairs, and at every point the horizontal shear τ is equal to the vertical shear. If nothing but shearing stresses act in any two adjacent sections, so that $\sigma = 0$ (as happens in a cylinder subject only to torsion), then any rectangle $ABCD$ * (Fig. 31) will be deformed by the pairs

* Formed by differential portions of two adjacent sections, AD and BC .—TRANS.

of stresses into a rhomboid, in which the diagonal AC has been lengthened, and BD shortened. The principal stresses are then $\sigma_1 = +\tau$ and $\sigma_{11} = -\tau$, and the angle $\alpha = 45^\circ$. These values appear directly from the rectangular form of the figure $ABCD$. If there is also to be considered the influence of the lateral dilation, it is evident that for this dilation, due to the corresponding stresses on the material in the proper directions,

$$\sigma = \left(1 + \frac{1}{m}\right)\tau, \text{ or with } m=4,$$

the allowable stress $\tau = 0.80 \sigma_s$, a value frequently employed in steel construction and one found by experiment.

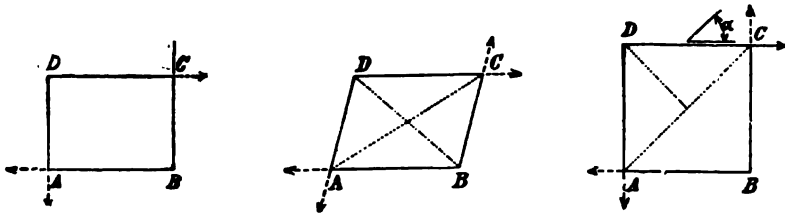

FIG. 31.

In distinction from the types of loading of Figs. 29 and 30 is that of Fig. 32. In the former, only shearing stresses (Schubspannungen) were supposed to act, that type being distinguished from other cases by the condition that the beam is subject only to flexure and consequently deflects. The other variety is the case of pure shear.* This differs from the foregoing, both spoken of as shear, in that no bending takes place and the external force is here theoretically applied only on a single section; while before, it was constant through several adjoining sections (or with a uniform load, varied only slightly from one to another). It is thus evident that pure shear is scarcely possible in practical work.

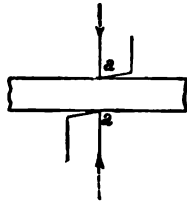

FIG. 32.

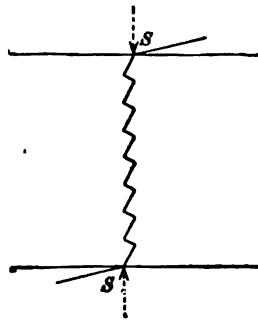

FIG. 33.



FIG. 34.

The action of concrete amply justifies a distinction between beam shearing stresses and pure shearing or punching stresses (Schub- und Scherspannungen), since they give entirely different surfaces of rupture and offer different resistances.

To obtain a relation between the compressive, tensile, and punching strengths, one may imagine the resistance to shear to be similar to that offered by a series

* Best illustrated by the action of a punch.—TRANS.

of small teeth, Fig. 33,* along the infinitesimal faces of which compressive and tensile forces act in oblique but mutually perpendicular directions. The horizontal components of these forces must balance among themselves, and the vertical components must equal the total shearing force S . Or, in other words, the shear ct in the vertical section of a tooth (Fig. 34) is the resultant of the two normal forces $b\sigma_x$ and $a\sigma_d$, and must pass through their point of intersection, which determines the perpendicularity of the faces of the teeth. Because of the condition that a rupture of this series of teeth can occur only when the compressive stresses σ_d and the tensile stresses σ_x simultaneously reach their ultimate values, a definite shape is imposed upon the right triangle abc and a definite relation must exist between the compressive, tensile, and shearing strengths. In the triangle of forces

$$c^2 t^2 = a^2 \sigma_d^2 + b^2 \sigma_x^2.$$

The equation of the horizontal components gives

$$b \sigma_x \frac{b}{c} = a \sigma_d \frac{a}{c},$$

or,

$$b^2 \sigma_x = a^2 \sigma_d,$$

which, in connection with the first equation, gives,

$$c^2 t^2 = b^2 \sigma_x \sigma_d + a^2 \sigma_x \sigma_d = \sigma_x \sigma_d (a^2 + b^2)$$

from which

$$t = \sqrt{\sigma_x \sigma_d}$$

The theoretical maximum pure shearing strength would therefore be the geometrical mean of the tensile and compressive strengths.

In an absolutely homogeneous material with equal tensile and compressive strengths, t would equal σ , or with regard to lateral dilation there is obtained

$$t = \frac{\sigma}{\left(1 + \frac{1}{m}\right)}.$$

In the case of actual tests of wrought iron and steel, the strength in pure shear equals 0.7 to 0.8 of the tensile strength, thus developing equally large shearing and torsional strengths (compare Bach, "Elastizität und Festigkeit"). With concrete, however, of which the tensile strength is not as large as the compressive strength, tests show that the shearing strength is considerably larger than the tensile one, and close to the theoretical value $t = \sqrt{\sigma_x \sigma_d}$.

Experiments † concerning Pure Shear in Concrete with the Arrangement shown in Fig. 36.—The 18 by 18 cm. (7 by 7 in.) prismatic concrete specimens were fixed on one side in a Marten testing machine, with cast-iron plates above and below, so that the space between the two upper plates corresponded

* Figures 32 to 43 are loaned by the "Schweizer Bauzeitung," where they were first published by the author.

† These and the following described experiments were made by the author.

accurately with the width of the lower plate. When the load was applied on the non-reinforced specimens, a crack *a* first showed itself in the middle, running from top to bottom. This was doubtless caused by a bending of the specimen. However, the load on the machine could yet be considerably increased, and only then did the load take full bearing on the edges of the plates, as is necessary in order to obtain the real shearing strength.

1. Test on three concrete specimens, mixed 1:3, with 14 per cent of water 18 by 18 cm. (7 by 7 in.) in section, age 2 years, Fig. 35.



FIG. 35.—Shear test.

The bending crack *a* appeared at a load $P=5$ tonnes (11,000 lbs.), but the load was increased to $P=40$ t. (88,000 lbs.) when shearing along crack *b* took place. In the second specimen, the bending crack appeared at $P=10$ t. (22,000 lbs.) and the shearing took place at $P=38$ t. (83,600 lbs.), while the third specimen sheared at $P=50$ t. (110,000 lbs.). On the assumption of an equal distribution of P between the two sections to be sheared, the shearing strengths of the three specimens result as shown in Table XI.

TABLE XI
SHEARING STRENGTH

$$t = \frac{20000}{18 \times 18} = 61.8 \text{ kg/cm}^2 \text{ (879 lbs./in}^2\text{)}$$

$$t = \frac{10000}{18 \times 18} = 58.7 \text{ kg/cm}^2 \text{ (835 lbs./in}^2\text{)}$$

$$t = \frac{25000}{18 \times 18} = 77.2 \text{ kg/cm}^2 \text{ (1098 lbs./in}^2\text{)}$$

$$\text{Average } 65.9 \text{ kg/cm}^2 \text{ (937 lbs./in}^2\text{)}$$

Tests of three specimens of each kind, and of the same age and mixture, 74 cm. (29.12 in.) high and 18 by 18 cm. (7 by 7 in.) in section, like Fig. 21,

broken at the Testing Laboratory of the Technical High School at Stuttgart, gave the following average values:

$$\text{Tensile strength } \sigma_t = \frac{8.8 + 15.8 + 22.7}{3} = 15.5 \text{ kg/cm}^2 \text{ (220 lbs/in}^2\text{)},$$

$$\text{Compressive strength } \sigma_d = \frac{350 + 342 + 233}{3} = 308 \text{ kg/cm}^2 \text{ (5405 lbs/in}^2\text{)}.$$

In accordance with the theory described above, the limit of shearing strength would be

$$t = \sqrt{\sigma_t \sigma_d} = \sqrt{15.5 \times 308} = 69 \text{ kg/cm}^2 \text{ (981 lbs/in}^2\text{)},$$

while the observed strength was $65.9 \text{ kg/cm}^2 \text{ (937 lbs/in}^2\text{)}$.

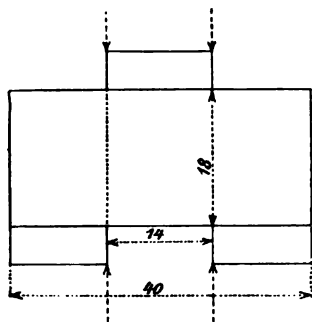

FIG. 36.
(Dimensions in cm.)

2. Test with 18 by 18 cm. (7 by 7 in.) concrete prisms, $1\frac{1}{2}$ months old, and 1:4 mixture with 14 per cent of water. The aggregate consisted of 3 parts sand of 0 to 5 mm. (0 to 0.2 in.) grains, and 2 parts of gravel of 5 to 20 mm. (0.2 to 0.78 in.) pebbles, and was also of the same quality as the other specimens. The arrangement is illustrated in Fig. 36.

Specimen 1: Bending crack in the middle at $P=15 \text{ t. (33,000 lbs.)}$; sheared at $P=25 \text{ t. (55,000 lbs.)}$. If a uniform distribution of stress is assumed, the unit shearing strength will be

$$t = \frac{12500}{.8 \times 18} = 38.6 \text{ kg/cm}^2 \text{ (549 lbs/in}^2\text{)}.$$

Specimen 2 gave $t=41.7 \text{ kg/cm}^2 \text{ (593 lbs/in}^2\text{)}$,

Specimen 3 “ $t=31.0 \text{ kg/cm}^2 \text{ (441 lbs/in}^2\text{)}$.

Tension and compression tests were not made in connection with these specimens. There exist, however, tests on concrete prisms like Fig. 21, 3 months old, of similar composition, of which the average of three strength tests were $\sigma_t=8.8 \text{ kg/cm}^2 \text{ (125 lbs/in}^2\text{)}$, and $\sigma_d=172 \text{ kg/cm}^2 \text{ (2446 lbs/in}^2\text{)}$, so that

$$t = \sqrt{8.8 \times 172} = 38.8 \text{ kg/cm}^2 \text{ (439 lbs/in}^2\text{)}.$$

The average of the three shearing tests is,

$$t = \frac{38.6 + 41.7 + 31.7}{3} = 37.1 \text{ kg/cm}^2 \text{ (528 lbs/in}^2\text{)}.$$

3. Tests with reinforced concrete prisms.

a. With straight rods only.

The experiments were performed on specimens of the same age, size, and mixture as the foregoing; but each specimen was reinforced with four rods 10 mm. (4/10 in.) in diameter, near the upper and the lower surfaces, as illustrated in Fig. 37. The rods were not connected by ties. They prevented a rupture of the specimen, reduced the size of the cracks, and allowed the load to be considerably increased after one shearing crack had appeared and until, and even after, the other crack had opened.

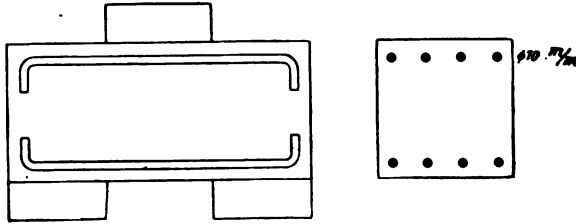

FIG. 37.

Specimen 1. At $P=12$ t. (26,400 lbs.) a fine, low, horizontal crack showed itself. At $P=15$ t. (33,000 lbs.) a fine bending crack became visible in the center, and shearing took place

on the left at $P=20$ t (44,000 lbs.), $t=31.0$ kg/cm² (441 lbs/in²),

on the right at $P=30$ t (66,000 lbs.), $t=46.3$ kg/cm² (659 lbs/in²),

Average, $t=38.6$ kg/cm² (550 lbs/in²).

In spite of these cracks, the load was increased to $P=42$ t. (92,400 lbs.) where the sole resistance against shear was the sixteen rod sections which then held

$$t_e = \frac{42,000}{16 \times 1^2 \times \frac{\pi}{4}} = 3350 \text{ kg/cm}^2 (47,650 \text{ lbs/in}^2).$$

Specimen 2 showed shearing cracks,

on the left at $P=18$ t (39,600 lbs.), $t=27.8$ kg/cm² (395 lbs/in²),

on the right at $P=27$ t (59,400 lbs.), $t=41.8$ kg/cm² (595 lbs/in²),

Average, $t=34.8$ kg/cm² (495 lbs/in²).

The load was increased to $P=40$ t. (88,000 lbs.) at which point a horizontal crack appeared at the left end. For this load

$$t_e = \frac{40,000}{16 \times \frac{3.14}{4} \times 1^2} = 3180 \text{ kg/cm}^2 (45,230 \text{ lbs/in}^2).$$

From Table I on page 17, the tensile strength of the reinforcement can be taken as 4200 kg/cm² (59,740 lbs/in²), so that its shearing strength would be about $0.8 \times 4200 = 3360$ kg/cm² (47,790 lbs/in²). The unequal shearing

resistances on the left and right can be explained in the first arrangement, as due to an unequal distribution of the load P on the two plates. In the latter case, the arithmetical mean gives the correct value of the shearing strength.

These tests show that the shearing cracks appeared in the reinforced prisms at practically the same load as in the non-reinforced ones, and consequently that only after the shearing strength of the concrete is exceeded does that of the iron come into play, but then is developed to its full value. With this manner of loading for pure shear, a combination of the strength of the two materials thus seems impossible of attainment. In any case final rupture depends on the resistance of the steel.

b. With some bent reinforcement.

In the two following tests (Fig. 38), besides two straight reinforcing rods 10 mm. ($4/10$ in.) in diameter, three bent ones of the same diameter were used,

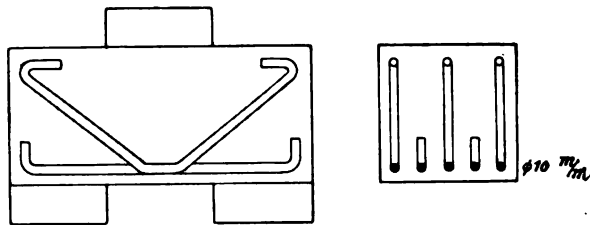

FIG. 38.

and so designed as to cut the shearing planes at an angle. Otherwise, the size, shape, and mixture were as before. The age was six weeks.

Specimen 1. Shearing crack,

on the right at $P=18$ t (39,600 lbs.), $t=27.8$ kg/cm² (395 lbs/in²),

on the left at $P=30$ t (66,000 lbs.), $t=46.4$ kg/cm² (660 lbs/in²),

Average, 37.1 kg/cm² (528 lbs/in²).

The load was increased to 35 t. (77,000 lbs.). When the area of a vertical section through the bent reinforcement along the plane of shear is taken into account, the area is increased 1.25 times, and the unit shearing stress is

$$t_e = \frac{35,000}{(4 + 6 \times 1.25) \frac{\pi}{4}} = 3870 \text{ kg/cm}^2 \text{ (55050 lbs/in}^2\text{)}.$$

Specimen 2. Shearing crack,

on the left at $P=16$ t (35,200 lbs.), $t=24.7$ kg/cm² (351 lbs/in²),

on the right at $P=25$ t (55,000 lbs.), $t=38.7$ kg/cm² (551 lbs/in²),

Average, 31.7 kg/cm² (451 lbs/in²).

The load was increased to $P=30$ t (66,000 lbs.); $t_e=3310$ kg/cm² (47,080 lbs/in²).

Specimen 3. A bending crack appeared at $P=12$ t (26,400 lbs.); shearing occurred

at the left at $P=15$ t (33,000 lbs.), $t=23.2$ kg/cm² (330 lbs/in²),

at the right at $P=28$ t (61,600 lbs.), $t=43.3$ kg/cm² (616 lbs/in²),

Average, 33.3 kg/cm² (473 lbs/in²).



FIG. 39.



FIG. 40.

Solid Cylinders.



FIG. 41.



FIG. 42.

Hollow Cylinders.

The load was increased to $P=32$ t (70,400 lbs.); $t_c=3540$ kg/cm² (50,350 lbs/in²).

Consequently, the same observations apply to tests *b* as to tests *a*.

Torsion Experiments with Concrete Cylinders.—In a cylinder undergoing a twist, without any axial forces at play, no normal stresses exist within any section, only shearing stresses acting, and at each point the latter are equal along directions parallel and perpendicular to the axis, so that all elements in the body are stressed, as is illustrated in Fig. 31, page 32.

It has been shown by the shearing experiments that the resistance offered by concrete to shear is somewhat greater than its tensile strength. Consequently rupture of a cylinder subject to torsion must take place along a screw surface with a pitch of 45° at right angles to the major dilation or the oblique tensile stresses. (See Figs. 39-42.)

These torsion experiments were made at the Testing Laboratory of the Royal Technical High School of Stuttgart. The mixture of the concrete was 1:4, and its age 2 to 3 months.

a. Solid cylinder, 26 cm. (10.24 in.) in diameter. The length of the specimen under test was 34 cm. (13.38 in.). (See Figs. 39 and 40.) The twisting moment was applied on the hexagonal heads. (See Table XIII.)

TABLE XIII
TORSIONAL STRENGTH OF SOLID CYLINDERS

| No. | Torque M_d . | | Torsional Strength according to the Formula $\tau_t = \frac{M_d}{\frac{\pi}{16}d^3}$ | | Age in Days. |
|------|----------------|------------|--|--------------------|--------------|
| | kg/cm | in/lbs | kg/cm ² | lb/in ² | |
| V | 61500 | 53300 | 18.2 | 259 | 89 |
| VI | 66500 | 57600 | 19.3 | 275 | 85 |
| VII | 46000 | 39800 | 13.3 | 189 | 79 |
| VIII | 59500 | 51500 | 17.6 | 250 | 98 |
| | | Average... | 17.1 | 243 | |

b. Hollow cylinders of the same external dimensions, with inner diameters about $d_0 = 15$ cm. (5.9 in.), gave the torsion moments shown in Table XIV.

TABLE XIV
TORSIONAL STRENGTH OF HOLLOW CYLINDERS

| No. | Torque M_d . | | Torsional Strength, $\tau_t = \frac{M_d}{\frac{\pi}{16} \left(\frac{d^4 - d_0^4}{d} \right)}$ | | Age in Days. |
|-------------|----------------|-------|--|---------------------|--------------|
| | kg/cm | in/lb | kg/cm ² | lbs/in ² | |
| XVI | 30000 | 26000 | 9.4 | 134 | 54 |
| XVII | 24500 | 21200 | 7.9 | 112 | 55 |
| XVIII | 29000 | 25100 | 9.3 | 132 | 52 |
| Average.... | 27830 | 24100 | 8.9 | 126 | |

The tensile strength of some hollow cylinders of similar section and equal age provided with the corresponding heads, gave an average of $\sigma_t = 8.0 \text{ kg/cm}^2$ (113.8 lbs/in²), while the similar above described tensile specimens, like Fig. 21, gave 7.7 kg/cm^2 (109.5 lbs/in²). The results found from the hollow cylinders agree quite satisfactorily with each other, while the above described theory for solid cylinders has not been confirmed.

Aside from the greater age of the solid cylinders, the greater value of τ_d is explained on the ground that since the modulus of elasticity diminishes with increase of stress, the sections near the center carry a relatively large part of the load, as is shown by the formula

$$\tau_d = \frac{M_x}{\frac{\pi d^3}{16}}$$

so that the load is reduced on the outer portion. The torsional strength of concrete, therefore, bears the same relation to its tensile strength as do the bending and tensile strengths. In this manner can be explained the high value of 17.1 kg/cm^2 (243 lbs/in²), when compared with the tension test specimens of the same material and mixture which gave about 9 kg/cm^2 (128 lbs/in²), when 3 months old. And with hollow cylinders, in which the rupture takes place along a screw surface with a 45° pitch and at right angles to the maximum tensile strains, the computed torsional stresses also correspond with the actual ones. It must be mentioned, however, that only through the use of extremely plastic concrete will this agreement be obtained, and only with wet concrete can the tamping be thoroughly effective, as is especially necessary with hollow cylinders.

With regard to torsion investigations concerning spirally reinforced concrete hollow cylinders, see page 53, "The extensibility of concrete."

Shearing Experiments with Slotted Concrete Beams.—These tests were conducted on specimens with slits molded along the neutral axis, so that with the method of loading shown in Fig. 43, the failure would take place by

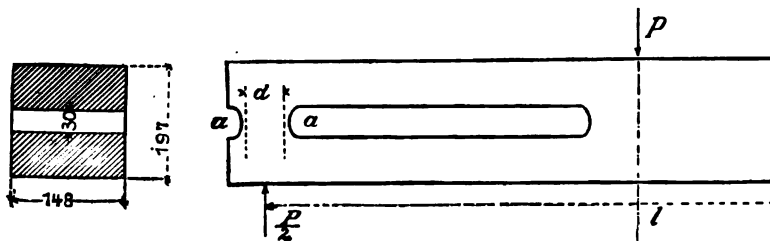

FIG. 43.

a shearing of the connecting bridges at the ends. The tests were made at the Testing Laboratory at Stuttgart.

At the ultimate load, the shearing stresses existing in the sections *a-a*, are calculated as follows:

The unit shear at any point x along the neutral plane is*

$$\tau = \frac{P}{2} \frac{S}{Jb}$$

where S is the statical moment of the cross-section lying above the neutral axis in relation to it, and J is the moment of inertia of the whole section. Thus the total shear from 0 to $\frac{l}{2}$ is

$$T = \tau b \frac{l}{2} = \frac{P S l}{2 J}$$

and the shearing strength in $a-a$ is given by

$$\tau = \frac{P S}{4 J} \frac{l}{bd}$$

It must be explained that the side subject to tensile stresses had to be reinforced, so that the weakest points in the body would be the bridges over the supports, and so that the specimen would not fail prematurely through tension.

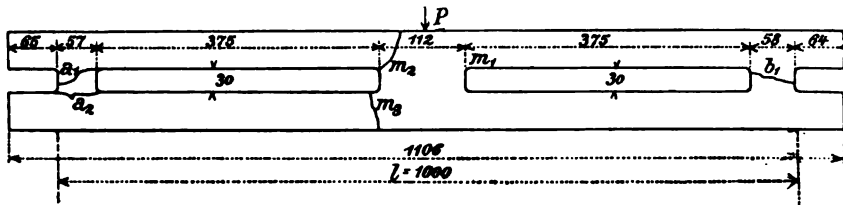

FIG. 44.—Slotted beam shear test.

Further, the bodies were not supported accurately under the centers of the bridges, so that some bending was experienced at those points. This would produce a result equivalent to a partial reduction in the effective width of the bridges, as compared with the original arrangement.

Example. Specimen "85," wet mixture, 1:3, age 105 days.

Under a load $P=1430$ kg. (3146 lbs.), the crack b_1 appeared conspicuously through the whole bridge.

At $P=1620$ kg. (3564 lbs.), a_1 showed itself through the whole bridge, and m_1 started in the edge.

* Total stress on plane = $\int_0^y p b d y$, but $M = \frac{p I}{y}$ or $p = \frac{M y}{I}$, so that stress = $\int_0^y \frac{M y}{I} b d y = \frac{M}{I} \int_0^y b d y$. $M = \int_0^x F d x = F d x$ when x is very small, so that F means stress in differential length of beam. Total stress = $\frac{F d x}{I} \int_0^y b d y$. Divide by area over which total stress acts = $b d x$ to get unit stress. Unit stress = $\frac{F d x}{I b d x} \int_0^y b d y = \frac{F}{I b} S$, where S is static moment of section above neutral axis about that axis.—TRANS.

At $P=1770$ kg. (3894 lbs.), a_2 appeared.

At $P=2000$ kg. (4400 lbs.), m_2 appeared.

Under a load of $P=2410$ kg. (5302 lbs.), a wide crack formed at m_3 and m_2 widened considerably. The load could not be further increased.

In Table XV the observed shearing strengths are given, together with the tensile and compressive strengths of the specimens illustrated in Fig. 21 (page 21). The results are, each, averages of three specimens.

TABLE XV
SHEARING, TENSILE AND COMPRESSING UNIT STRENGTHS

| Mixture. | 1:3 | | | | 1:4 | | | | 1:7 | | | |
|-------------------|--------------------|---------------------|--------------------|---------------------|--------------------|---------------------|--------------------|---------------------|--------------------|---------------------|--------------------|---------------------|
| | 8% | | 14% | | 8% | | 14% | | 8% | | 14% | |
| | kg/cm ² | lbs/in ² | kg/cm ² | lbs/in ² | kg/cm ² | lbs/in ² | kg/cm ² | lbs/in ² | kg/cm ² | lbs/in ² | kg/cm ² | lbs/in ² |
| Shear. | 36 | 512 | 30 | 427 | 31 | 441 | 28 | 398 | 26 | 370 | 19 | 270 |
| Tension. | 12.6 | 179 | 10.5 | 149 | 9.2 | 131 | 8.8 | 125 | 4.4 | 63 | 5.5 | 78 |
| Compression. | 280 | 3980 | 195 | 2770 | 220 | 3130 | 153 | 2180 | 127 | 1810 | 88 | 1251 |

The shearing strength for 1:4, here observed, of from 31 to 28 kg/cm² (441 to 398 lbs/in²), is a little smaller than the one found by direct shear, of 37 kg/cm² (526 lbs/in²). The reason probably lies in the not entirely rigorous methods of calculation used in connection with the slotted prisms, or else in that the solid end connections had an appreciable thickness, so that partially inclined cracks could occur from diagonal tension.

In practice, the case of pure shear is very rare. Diagonal tensile stresses are always combined with shearing ones, and the former become of critical importance long before the shear does, as the torsion experiments plainly show. This point will later be discussed more fully, in connection with shearing tests on beams.

Adhesion or Sliding Resistance between Steel and Concrete. Experiments aiming at the determination of the amount of adhesion between concrete and embedded steel, or the resistance offered to sliding, can be carried out in various ways. The resistance experienced by an embedded rod when drawn out can be directly measured, or the adhesion may be ascertained by computation from bending tests. Consideration will later be given to a discussion of experiments of the latter kind concerning adhesion, which naturally are of the greatest importance in this subject.

The published figures for directly ascertained adhesion, disclose many differences, produced by the variability of concrete, the method of test, the nature of the surface of the rod, etc. For a long period the value of the unit adhesion of from 40 to 47 kg/cm² (569 to 668 lbs/in²), determined by Bauschinger in his investigations for the A.-G. für Beton & Monierbau, was accepted. Among later experiments may be mentioned those of Tedesco,* with six-day old mortar

* "Du Calcul des ouvrages en ciment avec ossature métallique," by MM. Ed. Coignet and N. De Tedesco, Paris, 1894.

prisms which gave an adhesion of 20 to 25 kg/cm² (284 to 355 lbs/in²), and those of the "Service française des phares et balises,"* with 25 to 36 mm. (1 to 1½ in. approximately) round rods which were anchored for a length of 60 cm. (23.6 in.) with Portland cement into stone blocks. After setting for a month in the open air, the rods were pulled out. The adhesion was found to vary with the diameter of the rod, and was between 20 and 48 kg/cm² (284 and 682 lbs/in²).

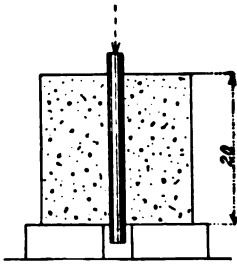

FIG. 45.

The larger values correspond with thicker rods, and with material possessing a higher elastic limit. With equal sections, the stress was quite constant, and was practically equal to the elastic limit of the steel involved.

Thus, the adhesion between concrete and steel was broken when the sections of the rods began to diminish perceptibly.

With a slow, regular withdrawal of the rods, almost as large a sliding resistance was disclosed, which varied between 39 and 71 kg/cm² (555 and 1010 lbs/in²) of surface of contact. The variation in this sliding resistance may be explained by the fact that the surface of commercial rod iron is not a mathematical cylinder.

Some experiments were made by the writer in 1904 on the "pressing through" of rods set in concrete, as is illustrated in Fig. 45. The cubes were 20 cm. (7.8 in.) on an edge; the concrete was mixed in the proportions of 1 to 4, with different percentages of water, and was four weeks old. The specimens did not crack, and it was shown that after the adhesion was overcome, there existed a considerable constant sliding resistance.

A second series of tests was made upon exactly similar cubes with 20 mm. (¾ in. approx.) rods, and special precautions were taken to prevent cracking of the concrete by embedding in it a 4.5 mm. (3/16 in. approx.) wire spiral with 3 cm. (1.2 in.) pitch and 10 cm. (3.9 in.) diameter. (Fig. 46.) The age of the specimens was four weeks. The results are as given in Table XVI.

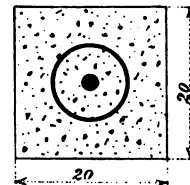
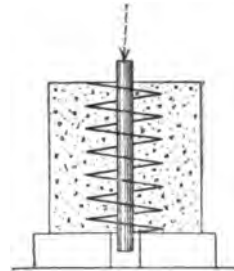

FIG. 46.

TABLE XVI
ADHESION TO ROUND RODS

| Per Cent of Water. | Adhesion from Average of Four Specimens. | | | |
|--------------------|--|---------------------|--------------------|---------------------|
| | Without Spiral. | | With Spiral. | |
| | kg/cm ² | lbs/in ² | kg/cm ² | lbs/in ² |
| 10 | 48.8 | 694 | 50.8 | 723 |
| 12.5 | 31.2 | 444 | 45.9 | 653 |
| 15 | 29.1 | 414 | 54.0 | 768 |

* Annales des ponts et chaussées, 1898, III.

The percentage of water given is only nominal, since the sand and gravel were moist. The pressure of the testing machine was increased rather rapidly for the larger loads.

The results approach closely the shearing strength of similar concrete specimens. The compressive stresses in the rods reached a maximum of 2140 kg/cm² (30,440 lbs/in²), and consequently were below their observed elastic limit of from 2600 to 3200 kg/cm² (36,980 to 45,520 lbs/in²).

Although the non-reinforced concrete cubes were not cracked by the pressing through of the rods, their adhesive strength was smaller than was that of the ones containing spirals.

The results of some American tests were published in "Engineering News," 1904, No. 10. The adhesive strength of rods of different shapes was examined for a mortar mix of 1 to 3 and for various concrete mixtures. With cubes of cement mortar, 15 cm. (6 ins.) on an edge, the average values of Table XVII were obtained:

TABLE XVII
AMERICAN ADHESION TESTS

| Section. | Unit Steel Stress σ_e | | Adhesive Strength. | |
|---|---------------------------------|---------------------|--------------------|---------------------|
| | kg/cm ² | lbs/in ² | kg/cm ² | lbs/in ² |
| Square, 12.5 by 12.5 mm. ($\frac{1}{2}$ inch)..... | 1570 | 22330 | 30.2 | 430 |
| Round, 12.5 mm. diameter ($\frac{1}{2}$ inch)..... | 1780 | 25320 | 35.8 | 509 |
| Flat, 25.4 by 6.5 mm. ($\frac{1}{2}$ by 1 inch)..... | 1270 | 18060 | 20.5 | 292 |
| Square, 6.5 by 6.5 mm. ($\frac{1}{4}$ inch)..... | 2430 | 34560 | 25.8 | 364 |

It is seen from this that the round rods developed a greater adhesive strength than the square ones, and considerably more than the flat iron.

Some concrete prisms 20 by 20 cm. (7.8 in.) in section and 25 cm. (10 in.) high, contained square rods 25 by 25 mm. (1 in. approx.), and developed adhesive strengths of 34 to 41 kg/cm² (484 to 583 lbs/in²), or an average of 37.5 kg/cm² (533 lbs/in²), which agrees well with the values found by Europeans.

In a very careful and exhaustive manner, Bach carried out a series of tests on the sliding resistance of steel embedded in concrete,* for the investigations of the Eisenbetonausschusses der Jubiläumstiftung der Deutschen Industrie. His results shed new light on the subject of adhesion.

The concrete specimens were made in the form of square prisms 22 cm. (8.7 ins.) on a side and with heights of 10, 15, 20, 25, and 30 cm. (4, 6, 8, 10, 12 in. approx.). The concrete was mixed in the proportions of 1:4, with Rhine sand and gravel, of which the aggregate contained 3 parts sand of 0 to 5 mm. (0 to 0.2 in.) grains and 2 parts gravel of 5 to 15 mm. (0.2 to 0.6 in.) pebbles. Heidelberg Portland cement was used, so that the specimens were exactly like those described on pages 43 and 44.

* "Versuche über den Gleitwiderstand einbetonierter Eisen," by C. v. Bach, Berlin, 1905, and also No. 22 of the "Mitteilungen über Forschungsarbeiten auf dem Gebiete des Ingenieurwesens."

The experiments included tests for the determination of the influence of the amount of water used, the quantity of sand, the influence of jarring the specimen before the concrete had set, and finally, time tests of specimens up to three months old. The following conclusions were deduced:

That percentage of water was best with which it was just possible to manufacture the specimens satisfactorily. With the proportions above described, this was 12 per cent.

Within certain limits, the relative proportions of sand and gravel have no important influence on the resistance to sliding, so long as the percentage of water is proportionately small when small amounts of sand are used.

The resistance to sliding will be increased by jarring the finished specimen before setting is completed, at least when the specimen stands on a wooden bottom, which gets jarred by being struck by other bodies. This increase is more important when small percentages of water are used, and is to be explained by the fact that, through the jarring, the grout which is necessary to a good bond will be enabled to collect around the reinforcement.

The sliding resistance is considerably greater in tests conducted at high rates of speed than at slower ones where the loads act for longer periods at each step. Also, tests in which rods are "pushed through" are somewhat higher than when they are "pulled through."

In regard to the practical employment of these results, it is to be noted primarily that it is impossible to obtain, in actual work, the exact percentage of water above mentioned, on account of humidity of the various aggregates, but that it is necessary to rely almost entirely on experience and good practice. On the other hand, an excess of water does not then have the harmful effect that it does on test specimens molded in solid cast-iron forms, since the wooden molds absorb a part of the water and some more is lost through the cracks between the boards. Furthermore, in building construction, the fresh concrete will receive plenty of jarring from the forms, so that the highest value obtained from the experiments, in which the specimens were shaken as well as tamped, may be assumed as a proper working stress.

A very important point, and one here brought out for the first time, is that for steel stresses far below the elastic limit, the unit adhesion diminishes with the length of rod embedded. The explanation of this phenomena is as follows: The tensile stress in the rod will decrease from the outside of the concrete to the inner end of the rod as the stress is transferred from its surface to the concrete. Because of its elasticity, the rod will stretch under the tension, while the concrete will be thrown into compression and will shorten. Consequently, even under small tensile stress, because of the changes of length in opposite directions in the two materials, a sliding effect will be produced along the rod, near its outer end, so that the tensile stress in the steel will not be uniformly distributed over the whole length of the rod embedded in the concrete. It will first be taken up by the adhesion at the outer end, and only after that is exceeded and a slight displacement takes place, will the distant parts of the concrete be stressed. It follows from this unequal distribution of stress, that the observed values of this stress are too small and that they should more properly be termed the "frictional resistance," as Bach has done. The shorter is the embedded

length of rod, the smaller are the tension and elongation, and the more nearly equally distributed will be the effect over the whole surface.

When the rods are pushed through, there exist practically the same conditions, but in less degree, because then the steel and concrete are loaded in like kind. Even then a slight sliding will occur very early along the outer portions of the rod. This slight sliding explains the influence shown by the rate of application of the load. It is easily seen that with a high rate, the sliding does not have time to develop, and that the adhesive stress is then more uniformly distributed over the embedded area of the rod.

In Fig. 47 are given the principal results of Bach's tests. They refer entirely to 1:4 concrete prisms with 15 per cent of water. The earlier tests were con-

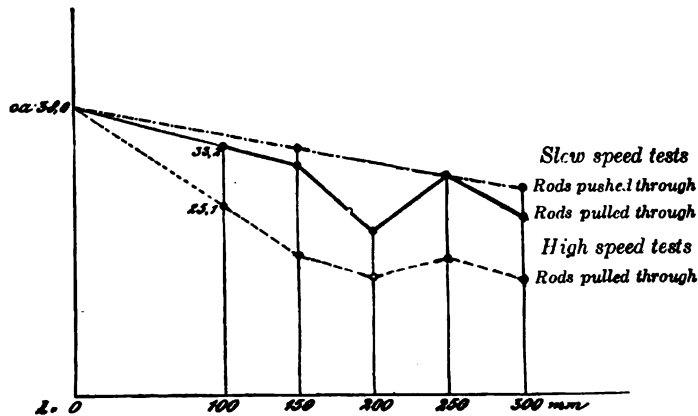

FIG. 47.—Results of adhesion experiments.

ducted with applications of load for short periods—each step occupied one-half a minute (which is really long as compared with most experiments). The embedded lengths of the rods are plotted as abscissas, and the observed resistances to sliding, as ordinates. If the curves for adhesion on pushed and pulled rods under short load periods, and also the curve showing the results for longer duration of load (from nothing up to 110 minutes) are extended to intersect the axis of ordinates, all three meet at practically the same point, which corresponds with an adhesive strength of 38 kg/cm^2 (540 lbs/in^2).

At this value, which corresponds to a length $l=0$, the influences of the embedded length of rod, of premature sliding, of time, and the difference between pulling and pushing, all vanish. This value of 38 kg/cm^2 (540 lbs/in^2), happens to correspond with that found by the author on specimens of the same mixture and age for shearing strength, and also approaches closely that for the quickly operated adhesion experiments. The low point of the middle curve at $l=200 \text{ mm}$. may be explained by the fact that those specimens were first manufactured, and the operator had not yet acquired proper experience.

In addition to the experiments on the slipping resistance of embedded round rods, made at the Testing Laboratory in Stuttgart, a series was also conducted with Thacher * bars. The specimens were again prepared of the same mixture

* Versuche mit einbetonierten Thacherisen von D.-Ing., C. v. Bach, Berlin, 1907.

of 1 part of Portland cement and 4 parts sand and gravel, with 15 per cent water. The height of the specimens was 20 cm. (7.9 in.), while the length of the side of the square base was, in some cases, 22 cm. (8.7 in.), some 16 cm. (6.3 in.), and some 10 cm. (3.9 in.), and the resistance to pulling out was found to vary with the diameter of the specimen, since all split when the Thatcher rods were withdrawn. If the pull P is uniformly distributed over the embedded surface (O), the resistance to sliding for the several specimens was as given in Table XVIII.

TABLE XVIII

UNIT ADHESION FOR DIFFERENT LENGTHS OF EMBEDMENT

| | Metric. | English. | Metric. | English. | Metric. | English. |
|---------------------------------|---------|----------|---------|----------|---------|----------|
| Length of side. | 22 cm. | 8.7 in. | 16 cm. | 6.3 in. | 10 cm. | 3.9 in. |
| $\frac{P_{\max.}}{O}$ | 58.5 | 832 | 56.1 | 799 | 33.4 | 475 |

It is evident from the last figure that with a minimum thickness of specimen equal to 3.75 cm. (1.5 in.), and with lesser values, the splitting effect of the knots

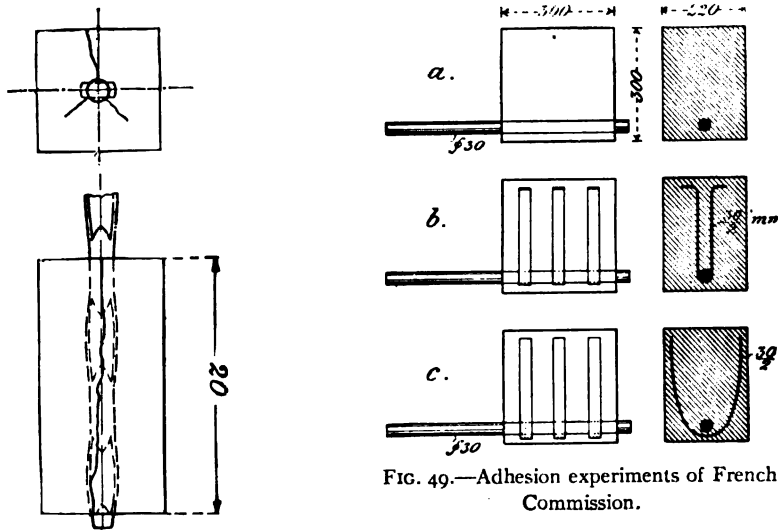

FIG. 48.

FIG. 49.—Adhesion experiments of French Commission.

is so great that greater adhesion cannot be expected than that of common round rods as they come from the mills.

With greater thickness of concrete the splitting occurred when the elastic limit of the steel had been reached.

Only those adhesion experiments in which the steel stress remains under the elastic limit, give a proper value of the adhesive strength to be used in the design of reinforced concrete structures, and consequently all steel must be so arranged as to length, shape, and thickness that it will effect a safe transfer of stress to the concrete. Actual tensile stresses are usually small, however, and

an increase up to the elastic limit through overloading of beams is seldom to be feared.

In singly reinforced slabs, the ends of the rods rest in large masses of concrete, so that a diminishing of the adhesion, because of premature cracking of the surrounding concrete, is not to be feared. In slabs, the amount of the embedding is less, but near the ends of beams, stirrups are introduced which surround the concrete to some extent, and so preserve its adhesive strength. In this connection are here given the valuable results of the French Reinforced Concrete Commission's* experiments: Certain prisms with centrally located rods were manufactured, in which only 2 to 2.5 cm. (0.8 to 1.0 in.) of concrete existed between the rod and the outside surface. Besides these, some were made without stirrups, as illustrated in Fig. 49. A second series had three flat iron stirrups 30 by 2 mm. ($1\frac{1}{8}$ by $\frac{5}{8}$ ins.) as are used in the Hennebique system, and which enclosed the 30 mm. ($1\frac{1}{8}$ in.) diameter rods tightly. In the third series, open stirrups of the same flat iron were employed, which enclosed a larger mass of concrete and were separated from the rods by a space of about 1 cm. ($\frac{3}{8}$ in.). The concrete was composed of 300 kg. (661 lbs.) of cement, 400 l (14 cu.ft.) sand, and 800 l (28 cu.ft.) gravel, with 8.8 per cent by weight of water, and were six months old at the time of the test. The resistances shown in Table XIX were developed against pulling the rods out of the concrete:

TABLE XIX
ADHESION IN THE PRESENCE OF STIRRUPS

| Specimen. | | | Starting Resistance. | | Average Sliding Resistance. | |
|---------------|---------|-------------------|--------------------------------|---------------------|--------------------------------|---------------------|
| Stirrups. | Figure. | No. of Specimens. | kg/cm ² of Surface. | lbs/in ² | kg/cm ² of Surface. | lbs/in ² |
| None. | 49a | 2 | 7.2 | 102 | 8.1 | 115 |
| | | | 19.9 | 283 | 14.2 | 202 |
| Hennebique.. | 49b | 2 | 20.0 | 284 | 17.2 | 245 |
| | | | 16.9 | 240 | 12.8 | 182 |
| Open. | 49c | 2 | 25.7 | 366 | 18.2 | 259 |
| | | | 29.8 | 424 | 21.2 | 302 |

A repetition of these experiments with specimens three months old (in which the stirrups of flat iron were replaced with 9 mm. ($\frac{3}{8}$ in.) rods, gave higher results, (see Table XX), each being the average of three specimens:

TABLE XX
ADHESION IN THE PRESENCE OF STIRRUPS

| Specimen. | Adhesion. | | Sliding Resistance. | |
|------------|--------------------|---------------------|---------------------|---------------------|
| | kg/cm ² | lbs/in ² | kg/cm ² | lbs/in ² |
| Figure 49a | 24.7 | 351 | 8.8 | 125 |
| Figure 49b | 26.1 | 371 | 17.7 | 252 |
| Figure 49c | 31.2 | 457 | 30.0 | 284 |

* Commission du ciment armé. Expériences, rapports, etc., relatives à l'emploi du béton armé. Paris, 1907.

It is seen that the open stirrups which surround the concrete have an advantage over those which enclose the rods more tightly, and that the adhesion then developed corresponds well with the Stuttgart results with rods in the centers of the specimens. Of interest are also the adhesion experiments of the French Commission on an old reinforced concrete beam, in which 5 mm. ($\frac{3}{16}$ in.) steel wire, because of its somewhat crooked nature, developed a resistance to sliding of 80 to 92 kg/cm² (1138 to 1308 lbs/in²). These results are of practical importance, since small rods are never absolutely straight.

CHAPTER IV
THEORY OF REINFORCED CONCRETE
EXTENSIBILITY

Extensibility of Reinforced Concrete.—Experiments with straight reinforced concrete prisms, in which the extension is produced by axial tensile stresses, have several disadvantages. These consist primarily in the great trouble in securing an exactly central application of the tensile stress, and the fact that the force can be transferred to the reinforcement only through large adhesive stresses, so that the ends of the specimens crack prematurely. In the first edition of this book were given several theoretical investigations concerning combinations of steel and concrete under certain assumed conditions with regard to the elasticities of the two materials.

Of much more value are tests in which the extensibility of reinforced concrete is ascertained through experiments on specimens subjected to flexure. Of such, the best known are Considère's. His first tests* were made on mortar prisms of square section 6 cm. (2.4 ins.) on a side, and 60 cm. (23.6 ins.) high, reinforced on the stretched side by round steel rods. The prisms were tested by fixing one end and applying at the other a bending moment in such manner that it was constant for all sections. The extension of the stretched side was then measured with each increase of load. The mixture was 1:3, and the reinforcement consisted of three round rods 4.25 mm. ($\frac{3}{16}$ in. approx.) in diameter. For comparison, a few prisms had no reinforcement. With one prism, the bending moment was increased so that the tension side was stretched 2 mm. per meter (0.002 ft. per foot). Then a moment was applied 139,000 times, which was from 44 to 71 per cent of the first moment, and after each application the return to the initial condition was complete. These repeated applications gave extensions of from 0.545 to 1.25 mm. per m. (0.000545 to 0.00125 ft. per foot). Small strips 12 by 15 mm. (0.5 by 0.6 in.) in section were then cut from the prisms, and the bending moment again applied. The resulting strength was surprisingly high, almost equal to that of fresh specimens. From the comparative tests of non-reinforced mortar prisms, it was found that the ultimate flexure was between 0.1 and 0.2 mm. (0.04 and 0.08 in.). It thus follows that in a reinforced concrete body the reinforcement gives the concrete the ability to bend to a considerably greater extent than when plain.

Considère explains this as follows: As is known, in a metal rod subjected to tensile stress, the latter is at first distributed uniformly throughout the whole length; but with increase of stress the rod contracts at some point, and will

* Génie Civil, 1899.

then undergo considerable stretching. Thus, the total measured length may have increased only 20 per cent, while in the neighborhood of the point of rupture the actual stretch has been 10 to 15 times this amount. If it is supposed that the phenomenon known as "reduction in area" also applies to cement mortar, then the total elongation measured between the ends will give only an average value, and the mortar will, in reality, possess a very much greater ability to stretch than this value represents. In reinforced construction the concrete is attached to the steel, which latter possesses a much higher elastic limit than does the concrete. When undergoing stress, therefore, the steel will still tend to have the extension distributed uniformly over its whole length, at a stress at which the concrete tends to contract locally. But the adhesion makes it necessary for the concrete to follow the steel in its extensibility. It will therefore endure throughout its whole length the maximum possible deformation, and rupture will finally take place with an elongation (measured over all) which is considerably larger than if reinforcement were present. This explanation given by Considère is obvious, if the phenomenon of "reduction of area" really exists in concrete.

In computations concerning these bending tests, Considère employed a method with reference to the relative distribution of stress between the concrete and steel, which made the concrete show no greater tensile strength than that developed by plain concrete prisms. This method was not entirely free from objections, and therefore Considère subsequently made some true tension tests with reinforced concrete prisms.* Mortar prisms of square section, 47 mm. (1.85 ins.) on a side, symmetrically reinforced with four wires 4.4 mm. ($\frac{3}{16}$ in. approx.) in diameter, were subjected to tension, and the stretch both in the reinforcement and the mortar was measured. They were always found practically equal. From the known modulus of elasticity of the reinforcement, and the measured stretch of the steel, could be computed the proportion of the total tensile stress P , carried by the reinforcement. The remainder, divided by the section of concrete, gave the unit tension in the mortar, to which its measured elongations corresponded.

The observed law between stress and strain is shown in Fig. 50. The ordinates represent the total tensile stress on the prisms, while the abscissas give the corresponding stretch in the reinforcement. As long as the load does not exceed a certain value, Oa , the strains increase uniformly and are very small.

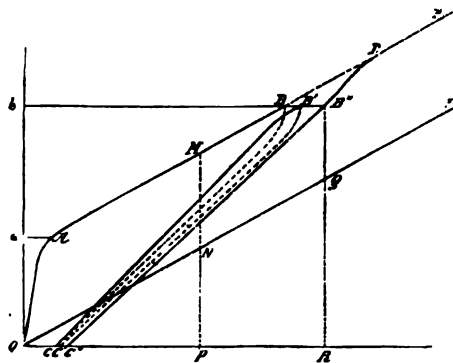

FIG. 50.

They then increase suddenly, but soon again become uniform and are represented by the flatter straight portion AB of the curve. From the measured stretch and the known area of the reinforcement, the part of the load carried

* Génie Civil, 1899.

by it can be calculated. The curve for the steel is practically a straight line as long as the elastic limit is not exceeded. In the figure, this straight line is represented by OF , which runs practically parallel with AB . For any stretch OP is then

PN equal to the part of the load, PM , carried by the steel,
 NM " " " " " " " " " " concrete.

It therefore follows from the curve that the concrete, in combination with the steel, is able to stretch considerably, but that after a certain elongation A , the stress on the concrete does not materially increase. The maximum stretch was 0.9 mm. (0.035 in.), which corresponds with a steel stress of 1800 kg/cm² (25,600 lbs/in²). (This is less than the first value of 2 mm. per meter, found by Considère). The lines CB , $C'B'$, $C''B''$, represent repeated loadings and unloadings.

Considère's tests were repeated by the French Government Commission* with somewhat larger prisms of 1:2:4 concrete. Similar results were obtained, and it was further discovered that the extensibility of reinforced concrete which had set under water was greater than that which had set in air.

Considère's tests very quickly became known, and were at once used by theorists in the formation of new methods of calculation, without waiting for confirmatory experiments or even considering the limitations placed by Considère himself on the practical value of his results.

In 1904 objections were raised to Considère's theory by both American and German experimenters, based on further tests made by them.

The experiments of A. Kleinlogel, conducted in the Testing Laboratory of the Royal Technical High School at Stuttgart were published in "Beton und Eisen," No. II, 1904, and also No. I of the "Forscherarbeiten aus dem Gebiete des Eisenbeton," Vienna, 1904. They comprised rectangular reinforced concrete beams, 220 cm. (86.6 ins.) long and 15 by 30 cm. (5.9 by 11.8 ins.) in section. The mixture was 1 cement:1 sand:2 crushed limestone. For purposes of comparison some beams were made without reinforcement. The beams were supported at the ends and loaded with two symmetrically placed loads, 1 meter (39.4 ins.) apart. The stretch of the lowest concrete layer was measured on a length of 80 cm. (31.5 ins.), included within the central portion of a beam. In order to make the cracks more evident, the lower face and both sides of the beams were painted with a coat of whitewash. The six-months' old beams, which had been kept in damp sand, gave practically equal maximum extensions of the lower concrete layer for several different percentages of reinforcement. This amounted to between 0.148 and 0.196 mm. per meter (0.000148 to 0.000196 ft. per foot).

Thus Considère's law was not confirmed, because the stretch of non-reinforced concrete was found about 0.143 mm. per meter (0.000143 ft. per foot). (According to Considère, it was 0.1 to 0.2 mm. per meter.)

Kleinlogel's tests also furnished important information about adhesion, to which reference will be made later.

* Beton und Eisen, No. V, 1903.

Because of the numerous objections raised concerning his hypothesis, Considère repeated his experiments with larger specimens.* The concrete consisted of 400 kg. (880 lbs.) of Portland cement, 0.4 cubic meters (0.52 cu.yds.) of sand, and 0.8 cubic meters (1.04 cu.yds.) of crushed limestone. The beams were of rectangular section, 3 meters (9.84 ft.) long, 15 cm. (6 ins.) wide, and 20 cm. (7.8 ins.) high, and were reinforced on the lower side with two round rods 16 mm. ($\frac{5}{8}$ in.), and three round rods 12 mm. ($\frac{1}{2}$ in. approx.) in diameter. As in the before-mentioned experiments they were tested with symmetrically placed loads, 1.4 meters (55 ins.) apart, within which distance the moment was uniform and no lateral forces acted. Of two specimens, one was kept under damp sand, and one under water for six months, at which age the specimens were tested. It was shown that the first beam stood a stretch between the layers *A* and *B*, of from 0.22 to 0.5 mm. (0.00866 to 0.0196 in.), and the second (which had been kept under water), stood a similar stretch of from 0.56 to 1.07 mm. (0.022 to 0.04 in.), Fig. 51. A crack could not be found even though the outer surface was coated with neat cement. The concrete between the layers *A* and *B* was sawed out and still showed the same strength as untouched concrete. Considère does not state (and such is the case with all his tests) whether he was able to cut away the section over the whole length of the beam in one piece, or whether in several.

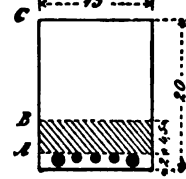

FIG. 51.

Of the experiments conducted by the Testing Laboratory of the Royal Technical High School at Stuttgart, concerning the extensibility of reinforced concrete, first will be discussed the

Torsion Tests on Hollow Cylinders with Spiral Reinforcement.—Hollow cylinders of the same dimensions as those described on page 39 were provided with spiral reinforcement having a pitch of 45° , in the centers of the walls. They were so arranged that torsion tests would produce tension in the spirals.

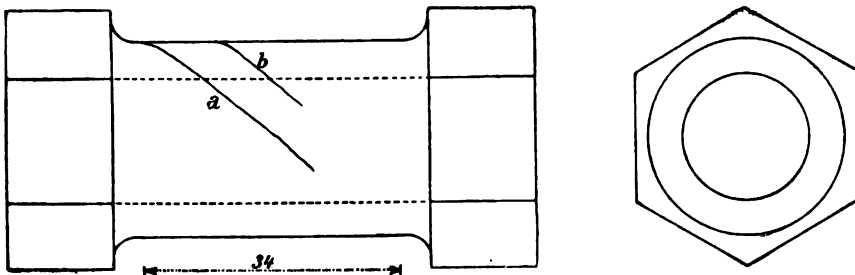

FIG. 52.

Cylinder IX, with five spirals of 7 mm. ($\frac{1}{4}$ in. approx.) round iron, was tested when 60 days old. Under a torque $M_d = 72,500$ cm-kg (62,800 in-lbs), two cracks, *a* and *b* (Fig. 52), at right angles to the spirals, were observed. The torque was increased to 86,500 cm-kg (74,900 in-lbs), at which load the cracks opened considerably.

* Beton und Eisen, No. III, 1905.

In Cylinder X, which corresponded exactly with the other, a fine crack appeared with $M_d=70,000$ cm-kg (60,600 in-lbs). The torque was, however, increased to 120,000 cm-kg (104,000 in-lbs) when further parallel cracks appeared.

If there is subtracted from the value for Cylinder IX at which the first cracks appeared, the torque $M_d=54,560$ cm-kg (47,200 in-lbs) carried by the non-reinforced hollow cylinders of equal age, there remains in Specimen IX the moment $M_e=17,940$ cm-kg (15,600 in-lbs).

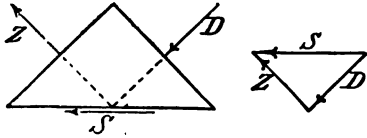

FIG. 53.

This gives, in the circle of 21 cm. (8.27 in.) diameter in which the spirals lay, a total horizontal circumferential strength

$$S = \frac{17940}{10.5} = 1710 \text{ kg (3762 lbs.)},$$

half of which must be taken up at the moment of cracking by the reinforcement which lies at an angle of 45° to this theoretical stress, and half by the compressive resistance of the concrete acting at right angles to the direction of the reinforcement. Consequently, from Fig. 53, $Z=D=\frac{S}{2}\sqrt{2}$, and the stress in the five spirals is

$$\sigma_e = \frac{855\sqrt{2}}{5 \times 0.7^2 \frac{\pi}{4}} = 630 \text{ kg/cm}^2 \text{ (8960 lbs/in}^2\text{)}.$$

This stress may also be obtained from the torque $M_e=17,940$, by a proper distribution of the inclined tensile stresses τ over the section of the reinforcement.

For cylinder X, the steel stress at the appearance of the first crack was found to be

$$\sigma_e = 540 \text{ kg/cm}^2 \text{ (7680 lbs/in}^2\text{)}.$$

With Cylinder XI, with 10 spirals of 10 mm. ($\frac{3}{8}$ in. approx.) round rods, otherwise like the foregoing, the first crack (a) appeared at $M_d=125,000$ cm-kg (108,200 in-lbs), with other cracks running in the same direction, and final rupture at $M_d=155,000$ cm-kg (134,200 in-lbs).

With the same suppositions as before, there is obtained for the steel stress at the appearance of the first crack

$$\text{in Cylinder XI, } \sigma_e = 603 \text{ kg/cm}^2 \text{ (8580 lbs/in}^2\text{);}$$

$$\text{“ “ XI, } \sigma_e = 560 \text{ “ (7970 “).}$$

It is thus found that with the four hollow cylinders the first cracks in the concrete appeared at an extension which corresponded with an average steel stress of

$$\sigma_e = \frac{630 + 540 + 603 + 560}{4} = 583 \text{ kg/cm}^2 \text{ (8290 lbs/in}^2\text{)}.$$

The extension at this stress is $\frac{583}{2160} = 0.27$ mm. per meter (0.00027 ft. per foot).

If the shearing stresses at the appearance of the first crack and at rupture are computed from the formula

$$\tau_d = \frac{Md}{\frac{\pi (d^4 - d_0^4)}{16} d}$$

the results of Table XXI are obtained:

TABLE XXI
SHEARING STRESSES AT FIRST CRACK AND AT RUPTURE

| Cylinder No. | At the First Crack, τ_d . | | At Rupture. | |
|--------------|--------------------------------|---------------------|--------------------|---------------------|
| | kg/cm ² | lbs/in ² | kg/cm ² | lbs/in ² |
| IX | 25.2 | 358 | 30.2 | 430 |
| X | 24.4 | 347 | 42.0 | 597 |
| XI | 43.6 | 620 | 49.5 | 704 |
| XII | 41.8 | 595 | 54.0 | 768 |

It may be concluded from this, that through a *proper* arrangement of the reinforcement, that is, by placing it in the direction of the maximum tensile stresses, the shearing strength of reinforced concrete can be increased over that of plain concrete.

In specimens with weak reinforcement, the stress at rupture rose to the ultimate stress in the steel; while with heavier reinforcement, such a stress could not be reached because the adhesion on the thicker rods was not sufficiently strong at the ends.

Bending Tests with Reinforced Beams of 15 by 30 cm. Section.

These specimens had the same dimensions as those tested by Kleinogel, but were made with 1 cement to 4 Rhine sand and gravel. They were constructed in December, 1902, and tested three months later at the Testing Laboratory at Stuttgart. They were consequently older than Kleinogel's specimens. They were tested with two symmetrically placed loads, so that a constant moment (with no external forces acting), was obtained throughout the central portion of 80 cm. (31.5 ins.) between the loads. Besides the stretch of the steel, the shortening of the top concrete layer was also measured, and the deflection within the measured length was also ascertained for different loads. The stretch in the steel was measured between projecting lugs AA, which were clamped to

the reinforcement. In the ends of the beams, the two reinforcing rods were arranged as shown in Fig. 54, and several stirrups were provided to counteract the local effects of the forces P and the shearing and adhesive stresses. These were such that no cracks appeared between the supports and the loads P .

The six specimens were severally reinforced with two 10 mm. ($\frac{3}{8}$ in. approx.), with two 16 mm. ($\frac{5}{8}$ in.), and with two 22 mm. ($\frac{7}{8}$ in.) rods. Of these beams, three were used for the determination of the steel stretch, and three for the shortening of the top concrete layer, because the apparatus was so designed that both observations could not be made simultaneously.

The tension face of each beam received a coat of whitewash to make the cracks easier of discovery. The first cracks x were always noted next the lugs A , probably because at those points the zone of tension in the concrete was weakened. Afterward, the cracks m , n_1 , and n_2 , appeared within the central portion. All, indeed, were so minute that they probably would not have been seen except for the coat of whitewash.

From the stretch in the plane of the reinforcement, and the shortening of the top layer, the extensibility of the lowest layer could be computed. The tests

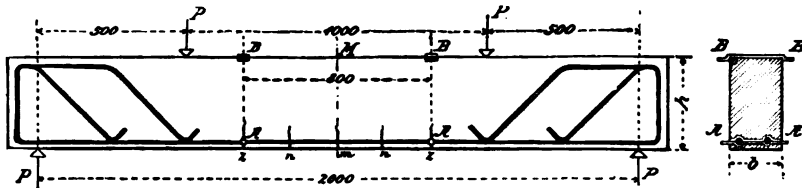

FIG. 54.

gave the values shown in Table XXII, at which the cracks appeared within the measured length:

TABLE XXII
EXTENSIBILITY EXPERIMENTS

| Number of Round Rods | Reinforcement. | | | Stretch of the Steel. | | Stretch of Lowest Concrete Layer. | |
|----------------------|----------------|---------------|-----------|-----------------------|---------|-----------------------------------|---------|
| | Diameter. | | Per Cent. | mm/m | ft/foct | mm/m | ft/foot |
| | mm. | in. | | | | | |
| 2 | 10 | $\frac{3}{8}$ | 0.4 | 0.42 | 0.00042 | 0.50 | 0.00050 |
| 2 | 16 | $\frac{5}{8}$ | 1.0 | 0.33 | 0.00033 | 0.40 | 0.00040 |
| 2 | 22 | $\frac{7}{8}$ | 1.9 | 0.30 | 0.00030 | 0.38 | 0.00038 |

This was about treble that of non-reinforced concrete. After the specimens were prepared, they were kept moist for a considerable time, but were tested in an air-dry condition. The difference between Considère's tests and those of other experimenters can be partially explained, since concrete which sets under water swells and therefore stands greater stretching than that which sets in air and decreases in volume. It is also to be noted that with each repetition of his experiments, Considère found smaller results. From 2 mm. they fell to

0.9 mm., and finally to 0.5 mm. per meter (from 0.0020 to 0.0005 ft. per foot). The latter figure does not differ much from the results on pages 53 to 55.

These bending tests will be discussed again later, in connection with the subject of the exact location of the neutral axis and the distribution of stress in the section. Also, there will be given an independent explanation of the large extensibility observed by Considère and of the stress distribution between steel and concrete, shown in Fig. 50. A complete statement is impossible without having first discussed the theory of reinforced concrete.

Similar experiments were carried out for the Reinforced Concrete Commission of the Jubiläumsstiftung der Deutschen Industrie in the Testing Laboratory at Stuttgart. In them, Bach* thoroughly investigated the appearance of the first crack in beams of which the material, proportions, and load distribution were similar to those illustrated in Fig. 54, and the outside of which was given a coat of whitewash. With increasing load on the under side of the beams, small damp spots first showed themselves. These spots grew in size as the load was augmented. With further increase, cracks appeared, always where a spot of water existed, but not all such spots developed into cracks. These phenomena, which had been described by Turneaure, "Engineering News," 1904, p. 213, and also by R. Feret, "Étude expérimentale du ciment armé," 1906, developed in beams which had been kept under water, and may be explained by their porosity in certain portions which were stretched by the tensile stresses and from which the moisture worked outward and so formed the spots of water on the surface. The cracks appeared on the sides of the beams at somewhat higher loads than on the bottom. It was further shown that the cracks usually commenced at the bottom corner, furthest from the reinforcement. In the section shown in Fig. 55 a crack existed at a load of 6000 to 6500 kg. (13,200 to 14,300 lbs.) at depths about as shown by the lines ab and cd , and advanced under a load of 7000 kg. (15,400 lbs.) to the positions of a_1b_1 , c_1d_1 . In the beams with a single reinforcing rod the cracks appeared somewhat later in the narrower beams than in the wider ones. The first corner crack was observed at a stretch of from 0.127-

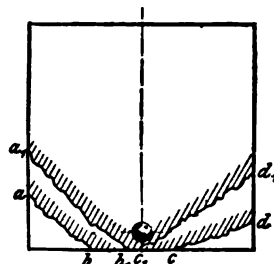

FIG. 55.

0.176 mm. in a length of one meter (0.000127-0.000176 ft. per foot) for a beam 15 to 30 cm. (5.9 to 11.8 ins.) wide with a single reinforcing rod. The spots of moisture always appeared with a stretch of 0.08-0.10 mm. per meter (0.00008 to 0.00010 ft. per foot), depending on the distribution of the steel in the section. This is, however, the ultimate stretch of plain concrete. The formation of cracks will be delayed if the reinforcement in the vicinity of the porous spots in the stretched concrete receives additional assistance. When the reinforcement was uniformly distributed over the whole width of the beam, the cracks were actually found after greater stretching, but were much smaller and correspondingly harder to discover. In heavily reinforced beams the extension

* "Versuche mit Eisenbeton-Balken," Part I., No. 39 of the Mitteilungen über Forschungsarbeiten and No. 26 of the Zeitschrift des Vereins Deutscher Ingenieure, 1907.

at which the first crack appeared was correspondingly increased to 0.267 mm. per meter (0.000267 ft. per foot). The maximum stretch, which amounted to 0.324 mm. (0.000324 ft.) for beams stored in moist sand, and 0.367 mm. (0.000367 ft.) for those in water, was found in beams in which the reinforcement was in the form of a plate 7 mm. ($\frac{1}{4}$ in. approx.) thick containing holes and extending across the full width of the beam.

The influence on the beams of dry and wet storage was also investigated. Beams of 30 by 30 cm. (12 by 12 in. approx.) section, provided on the under side with one round rod 26 mm. (1 in. approx.) in diameter, stored in air, stretched 0.097 mm. (0.000097 ft.), but those stored under water stretched 0.205 mm. per meter (0.000205 ft. per foot) before the appearance of the first crack. Since non-reinforced concrete which has been stored under water or in a moist condition swells, reinforced concrete which sets under water must develop tensile stress in the steel, and corresponding compressive and bending stresses in the concrete. These compressive stresses are naturally greatest in the layers near the reinforcement, and it is clear that when a load is applied it first overcomes these compressive stresses in the concrete and hence the stretch up to the first crack is greater than when concrete originally in an unstressed state, is stretched. In dry concrete which has set in the air, a reduction in volume or shrinkage takes place, so that in this case in unstressed beams the steel is compressed and the concrete subjected to tension and bending. Here the first crack will appear under less load and shorter stretch.

The experiments with T-beams, which will be described later, also contribute something concerning the extensibility of concrete.

Methods of calculation will next be considered, and in connection with them will be given further experiments on reinforced concrete bodies, so that the methods of computation can be checked by them.

CHAPTER V
THEORY OF REINFORCED CONCRETE
COMPRESSION

Calculation of Reinforced Concrete Columns with Longitudinal Rods and Ties.—In homogeneous bodies, subject to axial compressive stress, it is assumed that the resulting strain takes place by a lessening of the distance between adjacent imaginary parallel planes perpendicular to the line of stress, and in such manner that the planes remain mutually parallel after the strain. This same assumption is also made in the calculation of strains in concrete columns with longitudinal reinforcement if,

First, that portion of the axial stress borne by the concrete is assumed as uniformly distributed over the whole cross-section, and

Second, the reinforcement has the same deformation as the concrete.

If F_b represents the area of the concrete cross-section, F_e the total area of the reinforcement, σ_b and σ_e the corresponding stresses in the two materials when equally strained, the total load P will be

$$P = F_b \sigma_b + F_e \sigma_e.$$

In the design of any new column, either the experimentally determined stress-strain curve or the exponential law, $\epsilon_b = \alpha \sigma_b^m$, may be employed in selecting corresponding values of σ_e and σ_b , which can then be inserted in the general load formula. On the other hand it is only by the method of approximations, or of interpolation in tables, that it is possible to find the exact stresses in an existing column. In the "Leitsätze" of the Verbands Deutscher Architekten- und Ingenieurvereine, the ratio $\frac{E_e}{E_b} = n = 15$, is assumed as constant, so that with equal strains on steel and concrete,

$$\sigma_e = \frac{E_e}{E_b} \sigma_b = 15 \sigma_b,$$

and the column load is

$$P = \sigma_b (F_b + 15 F_e).$$

As the safe stress on concrete is assumed at $\sigma_b = 35 \text{ kg/cm}^2$ (497 lbs/in²), it follows that the safe load on a reinforced concrete column is

$$P = 35(F_b + 15F_e)\text{kg};$$

from which may be derived

$$F_b = \left(\frac{P}{35} - 15F_e \right) \text{cm}^2.$$

In given columns, the unit stresses will be

$$\sigma_b = \frac{P}{F_b + 15F_e}, \quad \text{and} \quad \sigma_e = 15\sigma_b.$$

The ratio $\frac{E_e}{E_b} = n$ is less than 15 within the limits of perfect elasticity, being approximately 10, but the higher value was chosen in the "Leitsätze" so as to take account of conditions near rupture.

One point with regard to reinforced concrete design deserves the greatest consideration. With homogeneous materials, the dimensions of pieces are usually determined from safe stresses which are definite fractions of the ultimate loads.* In reinforced concrete, however, the question arises whether *the allowable and assumed load distribution existing with safe stresses still continues near the point of rupture, or whether conditions change so that the real causes of rupture are different*, just as is the case in computations with regard to allowable tension in long columns. Nothing but experiments can afford information about these important questions.

Until 1905 compression tests of columns were very rare, although great responsibility is involved in their design and construction.

A column with 4½ per cent of reinforcement was tested at the Technical High School in Charlottenburg. Its sectional dimensions were 25 by 25 cm. (10 by 10 in. approx.), and height 3.22 m. (127 in.). The reinforcement was 4 round rods, 30 mm. (1¼ in.) in diameter, which were connected at 50 cm. (20 in.) intervals by horizontal flat iron ties 3 mm. by 80 mm. (¼ by 3 in. approx.); the mixture was 1:4, age 3 months. The column was prepared with accurate compression surfaces, and failed in such manner that the four rods buckled simultaneously between two ties, and the concrete between them crushed. The breaking strength was 255 kg/cm² (3627 lbs/in²).

If the reinforcing of concrete columns with longitudinal steel and horizontal ties is so done as to secure at least as much strength in the long members as in test cubes, then it is necessary, in designing, only to consider the strength of short specimens (or a certain part of such strength), and the load is $P = F_b \sigma_b$. The steel would then be entirely omitted from consideration, but at the same

* Exceptions, however, exist. For instance, the computation of the flexure at the breaking load will fail. The method of calculation of beams of the Schwedler type of construction is inaccurate, wherein the load is assumed greater so as to include the necessary safety in regard to diagonal tension. Also the computation of retaining walls and chimneys as to overturning.

time enough must be employed in the form of longitudinal reinforcement and ties, so that the breaking load of a reinforced concrete column will be equal to that of a small cube. It is evident that a certain minimum of steel is necessary. In the "Leitsätze," longitudinal reinforcement not less than 0.8 per cent of the cross-section is prescribed.

But the spacing of the ties also influences the breaking load of a column. Their effect is even greater than that of the longitudinal rods, as was proved by the latest experiments of the Reinforced Concrete Commission of the Jubiläumsstiftung der Deutschen Industrie.

These tests,* made in 1905, were conducted by Bach at the Testing Laboratory of the Royal Technical High School of Stuttgart, and involved concrete prisms 25 by 25 cm. (10 by 10 in. approx.) in section, and 1 meter (39.4 in.) long, mixed in the proportions of 1 part Portland cement and 4 parts of Rhine sand and gravel, with 15 per cent of water. Thus they were of the same composition as the specimens described on pages 44 to 46, used in the adhesion experiments.

Part of the specimens were without reinforcement. The others each had 4 rods with 7 mm. ($\frac{1}{4}$ in. approx.) ties arranged as shown in Fig. 56. Five varieties of reinforcement were employed, viz.:

- 15 mm. ($\frac{1}{2}$ in.) rods and 25 cm. (10 in.) tie spacing, Fig. 57
- 15 mm. ($\frac{1}{2}$ in.) rods and 12.5 cm. (5 in.) tie spacing, Fig. 58
- 15 mm. ($\frac{1}{2}$ in.) rods and 6.25 cm. ($2\frac{1}{2}$ in.) tie spacing, Fig. 58
- 20 mm. ($\frac{3}{4}$ in.) rods and 25 cm. (10 in.) tie spacing, Fig. 58
- 30 mm. ($1\frac{3}{8}$ in.) rods and 25 cm. (10 in.) tie spacing, Fig. 59

At the same time was ascertained the compressive strength of cubes, 30 cm. (12 in.) on each edge.

The elasticity in compression was measured for two or three specimens of each kind, for stresses up to 113 kg/cm² (1607 lbs/in²). It was disclosed that the shortening diminished not only with increased section of longitudinal steel,

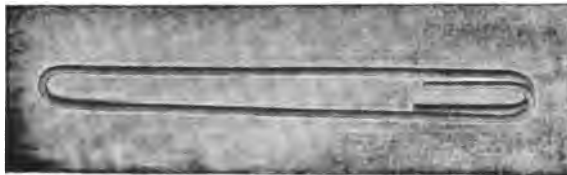

FIG. 56.

but also with increasing numbers of ties, when the longitudinal rods were the same. In the same manner as described on page 21, for stress increments of about 16 kg/cm² (228 lbs/in²) were measured, the total compression, the elastic deformation, and the permanent set. From these results, curves were determined similar to those for plain concrete. The influence of the ties on the elastic phenomena is shown in Table XXIII.

* C. v. Bach "Druckversuche mit Eisenbetonkörpern," 1905. "Mitteilungen über Forschungsarbeiten," No. 29.

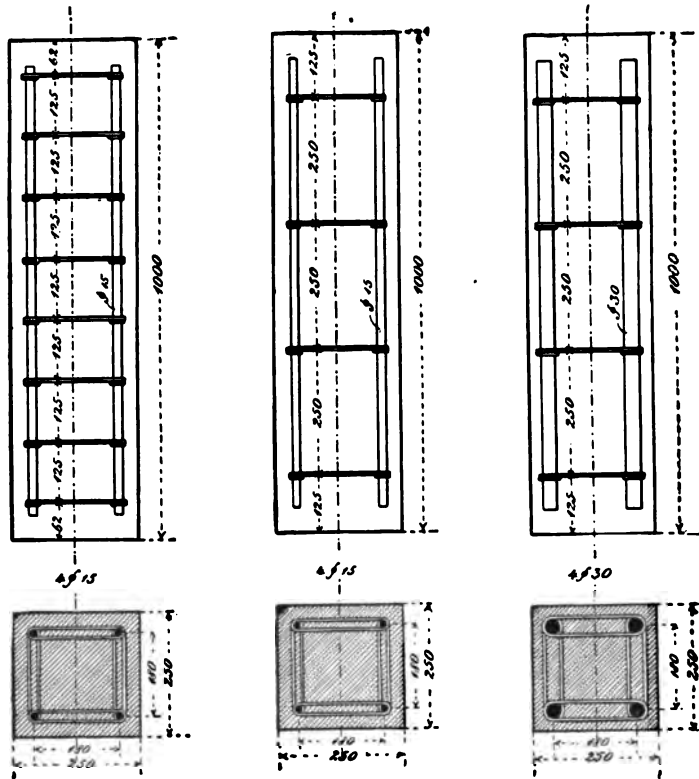

FIG. 57.

FIG. 58.

FIG. 59.

Test Specimens.

TABLE XXIII

ELASTICITY TEST OF COLUMNS

| Stresses | | Diameter of Rods | | Tie Spacing | | Shortening in Millionths of the Length | | |
|--------------------|---------------------|------------------|---------------|-------------|-------|--|--------------|---------------|
| kg/cm ² | lbs/in ² | mm. | in. | cm. | in. | Total | Elastic Dif. | Permanent Set |
| 32.3 | 459 | | Plain | concrete | | 133 | 7 | 126 |
| 32.3 | 459 | 15 | $\frac{3}{8}$ | 25 | 10 | 114 | 5 | 109 |
| 32.3 | 459 | 15 | $\frac{5}{8}$ | 12.5 | 5 | 110 | 2 | 108 |
| 32.3 | 459 | 15 | $\frac{3}{8}$ | 6.25 | 2½ | 106 | 4 | 102 |
| 64.6 | 919 | | Plain | concrete | | 333 | 37 | 296 |
| 64.6 | 919 | 15 | $\frac{3}{8}$ | 25 | 10 | 267 | 20 | 247 |
| 64.6 | 919 | 15 | $\frac{5}{8}$ | 12.5 | 5 | 264 | 18 | 246 |
| 64.6 | 919 | 15 | $\frac{3}{8}$ | 6.25 | 2½ | 241 | 13 | 228 |
| 97.0 | 1380 | | Plain | concrete | | 709 | 164 | 545 |
| 97.0 | 1380 | 15 | $\frac{3}{8}$ | 25 | 10 | 488 | 63 | 425 |
| 97.0 | 1380 | 15 | $\frac{5}{8}$ | 12.5 | 5 | 473 | 58 | 415 |
| 97.0 | 1380 | 15 | $\frac{3}{8}$ | 6.25 | 2½ | 421 | 42 | 379 |

It is there shown that, even with known elastic data for plain concrete, it is impossible to determine the distribution of stress between the steel and concrete with usual stresses, since the ties alter the elasticity of the reinforced concrete. They prevent lateral expansion of the concrete and thereby increase its compressive strength. The assumed ratio of the moduli of elasticity of steel and concrete is a close enough approximation. Actually it varies from 1:11 to 1:13 at the highest stresses covered by the elasticity experiments.

For practical purposes, the observed breaking strengths are more important. (See Table XXIV.)

TABLE XXIV
BREAKING STRENGTH OF COLUMNS

| Specimen about 3 Months Old | | | | Breaking Strength | | | | | |
|-----------------------------|------------------|-------------|-------|-------------------|-----|-----|---------------------|----------------------|--------------------|
| Diameter of Rods | | Tie Spacing | | Each | | | Average | | % of Reinforcement |
| cm. | in. | cm. | in. | | | | kg./cm ² | lb./in. ² | |
| | Plain | concrete | | 146 | 138 | 139 | 141 | 2010 | 0 |
| 15 | $\frac{5}{8}$ | 25 | 10 | 171 | 161 | 172 | 168 | 2390 | 1.14 |
| 15 | $\frac{5}{8}$ | 12.5 | 5 | 168 | 187 | 175 | 177 | 2520 | 1.14 |
| 15 | $\frac{5}{8}$ | 6.25 | 2½ | 212 | 200 | 203 | 205 | 2920 | 1.14 |
| 20 | $\frac{3}{4}$ | 25 | 10 | 169 | 169 | 172 | 170 | 2420 | 2.04 |
| 30 | 1 $\frac{3}{16}$ | 25 | 10 | 174 | 199 | 197 | 190 | 2700 | 4.60 |
| | Test | cubes | | { 168 | 169 | 171 | 175 | 2490 | 0 |
| | | | | 185 | 184 | | | | |

The appearance at fracture is shown in Figs. 60 to 64. According to the "Leitsätze" of the Verbands Deutscher Architekten- und Ingenieur-Vereine, the allowable loads for the prisms were as in Table XXV.

TABLE XXV
ALLOWABLE COLUMN LOADS

With four 15 mm. ($\frac{5}{8}$ in.) rods, $P = 625 \times 35 + 15 \times 7.1 \times 35 = 25602$ kg. (56324 lbs.)

With four 20 mm. ($\frac{3}{4}$ in.) rods, $P = 625 \times 35 + 15 \times 12.6 \times 35 = 28490$ kg. (62678 lbs.)

With four 30 mm. (1 $\frac{3}{16}$ in.) rods, $P = 625 \times 35 + 15 \times 28.3 \times 35 = 36732$ kg. (83010 lbs.)

These computed allowable loads are in the proportion of 168:187:241, while the actual loads on specimens with a 25 cm. (10 in.) tie spacing were as

$$168:170:190.$$

It is seen from these values that an increase in the area of longitudinal reinforcement does not produce an increase in the breaking strength to the extent which would be indicated by the formula

$$P = F_b \sigma_b + n F_c \sigma_c.$$

In experienced hands this formula may give rise to constructions which are not sufficiently safe. Some designers are careless with regard to this point, and, in order to produce columns of small diameter, increase the percentage of longitudinal reinforcement disproportionately. This gives such columns a calculated margin of safety which they do not possess.

When the increase in resistance is computed for one kilogram of steel in the form of longitudinal rods and of ties, it is discovered that the steel used as ties is nearly twice as effective as the straight rods. The former must, therefore, be given proper attention in the design of columns. Further experiments with long columns, in which the top and bottom are broadened to guard against premature failure, would be very desirable, and are planned by the Reinforced Concrete Commission.



FIG. 60.

FIG. 61.

FIG. 62.

FIG. 63.

FIG. 64.

Results of Crushing Tests.

It is recommended, until further tests are available, in reinforced concrete building construction designed in accordance with the formulas of the German "Leitsätze," that 20 kg/cm^2 (284 lbs/in^2) be assumed for the columns of the upper floor, and that this stress be increased in the lower floors to the maximum safe limit. The longitudinal reinforcement should be from 0.8 to 2.0 per cent, and the tie spacing approximately 5 cm. (2 in.) less than the diameter of the column, but never over 35 cm. (13.8 in.). If the strength of test cubes is made the basis for assumed safe loading without at all considering the steel, then the stresses may range from 25 kg/cm^2 (355 lbs/in^2) in the top story to 45 or 50 kg/cm^2 (640 to 710 lbs/in^2) in the lower ones. It is hardly imaginable that all floors of a building will ever be simultaneously fully loaded, so that the columns of the lowest story are very seldom fully stressed, and consequently are most favored.

The computation of the tie spacing solely from the buckling length of the longitudinal steel, too often calls for excessive spacings. Furthermore, in prac-

tice, the actual spacings are not mathematically exact, and do not remain fixed during the tamping of the concrete. They should prevent lateral bulging of the concrete, and must therefore possess ample strength to resist lateral failure.

Flexure.—No tests of the breaking strength of reinforced concrete columns exist, comparable with those for steel. It therefore becomes necessary, in designing in reinforced concrete, to employ data applicable to all homogeneous bodies. Tetmajer shows that Euler's formula

$$P = \frac{\pi^2}{l^2} EJ$$

applies to long, slender steel columns, if the compressive stress lies below the elastic limit when failure commences. To large cross-sections and short lengths, this formula probably does not apply, because the compressive stress at the breaking point has exceeded the elastic limit. Under such circumstances E , the modulus of elasticity, is not a constant. In all materials such as concrete which

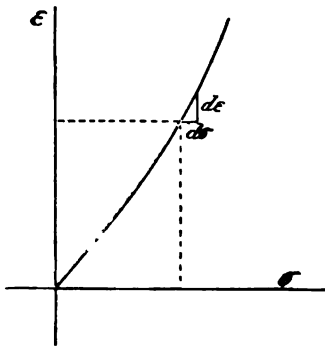

FIG. 65.

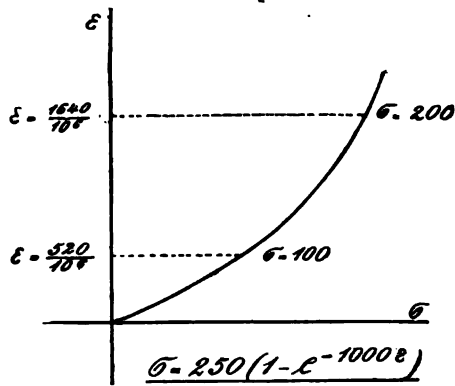

FIG. 66.

do not possess a constant modulus, it is necessary to ascertain (by calculation from experiments), a value for E which will correspond with the compressive stress at the moment of rupture, in such manner that it may be measured by the tangent of the angle of inclination of the stress-strain curve and be expressed by

$$E = \frac{d\sigma}{d\varepsilon}$$

In calculating the area of the cross-section involved in the moment of inertia J , the area of the steel must be multiplied by the ratio E_c/E_b . No change in the distribution of stress can take place with such procedure, since the area of the reinforcement is replaced by a concrete area E_c/E_b times as large.

Since the exponential law of stress-strain variation applies only to stresses up to about 40 kg/cm² (568 lbs/in²), neither can that law be utilized for the derivation of a suitable breaking formula.

In the 1899 volume of the Schweizerische Bauzeitung, is a communication by Ritter giving another basis for a formula. In it the following equation is employed:

$$\sigma = K(1 - e^{-1000\epsilon}),$$

K represents the ultimate stress in the concrete, E the corresponding strain, and $e = 2.71828$, the base of the system of natural logarithms. If the locus of this equation is plotted, the curve will be found to agree as well as can be expected with the stress-strain curves found by experiment under varying circumstances.

By differentiating σ with respect to ϵ , the modulus of elasticity E is obtained.

$$E = \frac{d\sigma}{d\epsilon} = K 1000 e^{-1000\epsilon} = 1000(K - \sigma).$$

If this value is inserted in Euler's formula, there results

$$P = \frac{\pi^2}{l^2} EJ = \frac{\pi^2}{l^2} 1000(K - \sigma)J;$$

σ therefore represents the initial breaking stress. If P is replaced by $F\sigma$, J by Fr^2 , and π^2 by 10, there is obtained for the breaking stress

$$\sigma_b = \frac{K}{1 + 0.0001 \frac{l^2}{r^2}}.$$

Example. Let it be desired to obtain the breaking load on a column having a cross-section of 25 by 25 cm. (9.84 by 9.84 in.) reinforced with 4 rods 18 mm. (0.708 in.) in diameter,

$$l = 4 \text{ m. (157.48 in.)}, \quad \frac{E_c}{E_b} = 10, \quad K = 250 \text{ (3555)},$$

$$J = \frac{1}{12} 25^4 + 10 \times 4 \times 0.9^2 \times \pi \times 10^2 = 42702 \text{ cm}^4,$$

$$\left(= \frac{1}{12} 9.84^4 + 10 \times 4 \times 0.354^2 \times \pi \times 3.987^2 = 1025 \text{ in}^4 \right);$$

$$F = 25^2 + 10 \times 4 \times 0.9^2 \times \pi = 727 \text{ cm}^2,$$

$$\left(= 9.82^2 + 10 \times 4 \times 0.354^2 \times \pi = 113 \text{ in}^2 \right);$$

$$r^2 = \frac{J}{F} = 58.7 \text{ cm}^2 \text{ (9.1 in}^2\text{)};$$

$$\sigma_k = \frac{250}{1 + 0.0001 \times \frac{400^2}{58.7}} = 197^2 \text{ kg/cm}^2,$$

$$\left(= \frac{3555}{1 + 0.0001 \times \frac{157.48^2}{9.1}} = 2802 \text{ lbs/in}^2 \right).$$

With a factor of safety against rupture of eight, a safe working compressive stress of 25 kg/cm² (355 lbs/in²) can be assumed. If partially fixed ends are considered, a corresponding free length of $\frac{3}{4} l$ should be employed, and σ_k will be somewhat larger. A somewhat closer result might be obtained with $n = 11$.

In the example above, a comparatively slender column has been assumed. It is evident from the result of the calculation that reinforced concrete columns differ very materially from iron ones, the risk of breakage being much greater in the latter. The superiority of reinforced concrete is due to the greater sectional area (as compared with steel) and the smaller unit stress. Or, in terms of the Euler formula, the moment of inertia J is increased in greater ratio than the modulus of elasticity is reduced, when compared with a steel column of equal carrying capacity.

Consequently, with concrete, only in exceptional cases will there be required a special calculation of the safety against rupture by flexure.

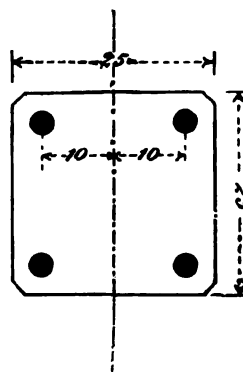

FIG. 67.

Calculation of Reinforced Concrete Columns with Spiral Reinforcement

(BETON FRETTE)*

Considère's method of calculating spirally reinforced columns will here be followed. From theoretical considerations, the correctness of which has been fully established by experiment, Considère reached the conclusion that reinforcement, if introduced in the form of a spiral, ensured an increase in the carrying capacity 2.4 times as great as would be obtained with the same amount of reinforcement in the shape of longitudinal rods.

If F_b represents the area of the concrete core, k the ultimate stress of non-reinforced concrete, f_c the cross-section of the longitudinal reinforcement, f_e' the cross section of imaginary longitudinal rods, of which the weight is equal to that of the spirals in an equal length of column, σ_e the elastic limit of the rein-

* Patented in France, Germany, England, United States, etc.

forcement (which, for commercial material, may be assumed at 2400 kg/cm^2 ($34,140 \text{ lbs/in}^2$)), then the ultimate load is given by the formula

$$1.5kF_b + \sigma_c(f_c + 2.4f_c').$$

In this expression, it is supposed that the elastic limit of the reinforcement determines the carrying capacity of the column. The factor 1.5 is employed because an octagonal cross-section, together with other usual conditions, make the gross sectional area about equal to 1.5 times the central portion enclosed by the spiral. It thus equals $1.5F_b$ of the whole concrete section.

Considère* proved that test specimens, prepared with the care possible in a laboratory, developed very considerable compressive strength. The owners

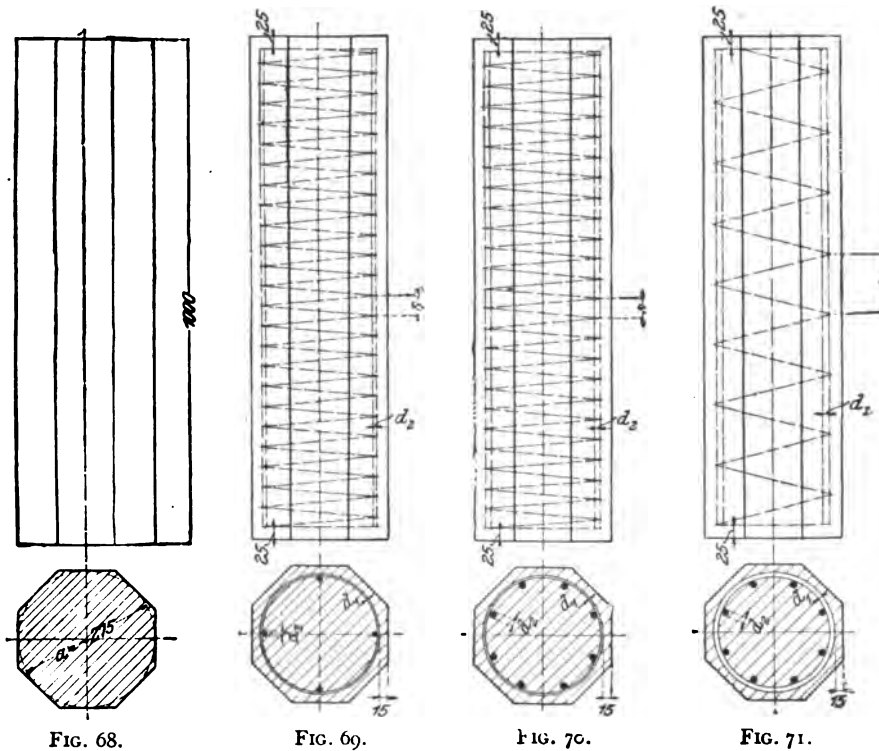

FIG. 68.

FIG. 69.

FIG. 70.

FIG. 71.

Test Specimens.

of the German rights under Considère's patents, deemed it advisable to institute experiments with specimens manufactured without special care, at a building site. As a consequence, in the specimens so prepared, the pitch of the spirals was rendered somewhat irregular by the ramming of the concrete, and some eccentricity of position was perceptible. In the earlier tests the longitudinal reinforcement had a sectional area of at least one per cent of that of the specimen, with a pitch in the spirals of one-seventh of the diameter of the column. The

* Génie Civil., Nov., 1902, Beton und Eisen, No. V, 1902.

later experiments were intended to show whether it is advisable to increase the pitch of the spirals appreciably beyond this ratio.

The specimens had an octagonal section with a diameter of 27.5 cm. (10.8 in.) and a length of 1.00 m. (39.37 in.), and were made of a mixture of 1 part by volume of Heidelberg Portland cement, to 4 parts of Rhine sand and gravel, with 14 per cent (by volume) of water. They were between 5 and 6 months old when tested. Three specimens of each kind were broken. Their general dimensions are given in Figs. 68 to 71 and Table XXVI.

TABLE XXVI
DIMENSIONS OF CONSIDÈRE COLUMN TESTS

| No. | Average of No. of Specimen | Figure | Spiral | | | | Longitudinal Reinforcement | | | |
|---------|----------------------------|--------|--------------------|----------------|----------------|------|----------------------------|----------|----------------|--|
| | | | Thickness <i>d</i> | | Pitch <i>s</i> | | No. of Rods | Diameter | | |
| | | | mm. | in. | mm. | in. | | mm | in. | |
| I | 4 | 68 | None | None | None | None | .. | .. | .. | |
| II | 3 | 69 | 5 | $\frac{3}{16}$ | 38 | 1.50 | 4 | 7 | $\frac{1}{4}$ | |
| III | 3 | 69 | 7 | $\frac{1}{4}$ | 37 | 1.46 | 4 | 7 | $\frac{1}{4}$ | |
| IV | 3 | 69 | 10 | $\frac{3}{16}$ | 42 | 1.62 | 4 | 7 | $\frac{1}{4}$ | |
| V | 3 | 70 | 5 | $\frac{3}{16}$ | 38 | 1.50 | 8 | 11 | $\frac{7}{16}$ | |
| VI | 3 | 70 | 7 | $\frac{1}{4}$ | 37 | 1.46 | 8 | 11 | $\frac{7}{16}$ | |
| VII | 3 | 70 | 10 | $\frac{3}{16}$ | 43 | 1.70 | 8 | 11 | $\frac{7}{16}$ | |
| VIII | 3 | 69 | 7 | $\frac{1}{4}$ | 31 | 1.22 | 4 | 7 | $\frac{1}{4}$ | |
| IX | 3 | 69 | 10 | $\frac{3}{16}$ | 40 | 1.58 | 4 | 7 | $\frac{1}{4}$ | |
| X | 3 | 69 | 12 | $\frac{1}{2}$ | 41 | 1.62 | 4 | 7 | $\frac{1}{4}$ | |
| XI | 3 | 69 | 14 | $\frac{9}{16}$ | 37 | 1.46 | 4 | 7 | $\frac{1}{4}$ | |
| XII' | 3 | 70 | 7 | $\frac{1}{4}$ | 40 | 1.58 | 8 | 5 | $\frac{7}{16}$ | |
| XII'' | 3 | 70 | 10 | $\frac{3}{16}$ | 40 | 1.58 | 8 | 7 | $\frac{3}{16}$ | |
| XII''' | 3 | 70 | 14 | $\frac{9}{16}$ | 40 | 1.58 | 8 | 10 | $\frac{3}{16}$ | |
| XIII' | 3 | 71 | 7 | $\frac{1}{4}$ | 80 | 3.16 | 8 | 7 | $\frac{1}{4}$ | |
| XIII'' | 3 | 71 | 10 | $\frac{3}{16}$ | 80 | 3.16 | 8 | 10 | $\frac{3}{16}$ | |
| XIII''' | 3 | 71 | 14 | $\frac{9}{16}$ | 80 | 3.16 | 8 | 12 | $\frac{3}{16}$ | |
| XIV' | 3 | 71 | 7 | $\frac{1}{4}$ | 120 | 4.72 | 8 | 10 | $\frac{3}{16}$ | |
| XIV'' | 3 | 71 | 10 | $\frac{3}{16}$ | 120 | 4.72 | 8 | 12 | $\frac{1}{2}$ | |
| XIV''' | 3 | 71 | 14 | $\frac{9}{16}$ | 120 | 4.72 | 8 | 14 | $\frac{9}{16}$ | |

In some of the tests* the permanent and elastic deformations were both measured, but no definite law could be deduced from the results except that the reinforced columns displayed somewhat less deformation, or a greater modulus of elasticity than those which were not reinforced, just as was noted with regard to the ordinary (simply longitudinally reinforced) concrete prisms already described.

In all cases the load was noted at which the first cracks were observed, as well as the ultimate load. The cracks appeared first in the concrete layer outside the spiral, and large fragments of that shell finally became detached. The types of failure are shown in Figs. 72 and 73.

* The tests were made at the Testing Laboratory of the Royal Technical High School at Stuttgart. The results were published by the president, Bach, in "Druckversuche mit Eisenbetonkörpern, Versuch. B." Berlin, 1905. Also in No. 29 of "Mitteilungen über Forschungsarbeiten."

Table XXVII gives the results of the tests, together with the increase in strength developed by the reinforced specimens as compared with specimen I, which were without reinforcement.

TABLE XXVII
RESULTS OF CONSIDÈRE COLUMN TESTS

| No. | Figure | Unit Stress of First Crack σ_1 | | Increase over Non-reinforced Column $\sigma_1 - 133$, etc. | | Ultimate Unit Load σ_2 | | Increase over Non-reinforced Column $\sigma_2 - 133$, etc. | | Ultimate Unit Load on Central Core | |
|---------|--------|---------------------------------------|---------------------|---|---------------------|-------------------------------|---------------------|---|---------------------|------------------------------------|---------------------|
| | | kg/cm ² | lbs/in ² | kg/cm ² | lbs/in ² | kg/cm ² | lbs/in ² | kg/cm ² | lbs/in ² | kg/cm ² | lbs/in ² |
| I | 68 | 133 | 1892 | ... | | 133 | 1892 | ... | | ... | |
| II | 69 | 159 | 2262 | 26 | 370 | 159 | 2262 | 26 | 370 | 230 | 3272 |
| III | 69 | 161 | 2290 | 28 | 398 | 178 | 2532 | 45 | 640 | 257 | 3656 |
| IV | 69 | 170 | 2418 | 37 | 516 | 240 | 3414 | 107 | 1522 | 347 | 4936 |
| V | 70 | 224 | 3186 | 91 | 1294 | 226 | 3215 | 93 | 1323 | 327 | 4651 |
| VI | 70 | 230 | 3272 | 97 | 1380 | 230 | 3271 | 97 | 1379 | 332 | 4722 |
| VII | 70 | 243 | 3442 | 110 | 1550 | 281 | 3997 | 148 | 2105 | 406 | 5775 |
| VIII | 69 | 196 | 2788 | 63 | 896 | 200 | 2845 | 67 | 953 | 289 | 4111 |
| IX | 69 | 170 | 2418 | 37 | 526 | 211 | 3001 | 78 | 1109 | 305 | 4936 |
| X | 69 | 180 | 2560 | 47 | 668 | 256 | 3641 | 123 | 1749 | 370 | 5263 |
| XI | 69 | 158 | 2247 | 25 | 355 | 246 | 3499 | 113 | 1607 | 355 | 5050 |
| XII | 70 | 163 | 2318 | 30 | 426 | 163 | 2318 | 30 | 426 | 236 | 3357 |
| XII | 70 | 164 | 2333 | 31 | 441 | 230 | 3271 | 97 | 1379 | 332 | 4722 |
| XII | 70 | 184 | 2617 | 51 | 725 | 302 | 4295 | 169 | 2403 | 436 | 6202 |
| XIII' | 71 | 162 | 2304 | 29 | 412 | 162 | 2304 | 29 | 412 | 234 | 3328 |
| XIII'' | 71 | 179 | 2546 | 46 | 654 | 181 | 2574 | 48 | 682 | 261 | 3713 |
| XIII''' | 71 | 186 | 2646 | 53 | 754 | 199 | 2830 | 66 | 938 | 298 | 4239 |
| XIV'' | 71 | 155 | 2205 | 22 | 313 | 155 | 2205 | 22 | 313 | 224 | 3185 |
| XIV''' | 71 | 183 | 2603 | 50 | 711 | 183 | 2603 | 50 | 711 | 264 | 3755 |
| XIV'''' | 71 | 207 | 2944 | 74 | 1052 | 207 | 2944 | 74 | 1052 | 299 | 4253 |

Table XXVIII gives the results of applying Considère's formula to specimens V, VI, and VII, with $k = 133$ (1888 lbs/in²) and $\sigma_e = 2400$ (3414 lbs/in²).

TABLE XXVIII
COMPARISON OF RESULTS OF CONSIDÈRE COLUMN TESTS

| No. | Concrete Core | | | | Area of Reinforcement | | | | Strength of Reinforcement. | | Ultimate Strength | | | |
|-----|-----------------|-----------------|---|--------|-----------------------|-----------------|-----------------------------------|-----------------|--|--------|-------------------|----------|----------|----------|
| | Area, F_b | | Strength, $1.5 \times 133 F_b$ $1.5 \times 1890 F_b$ | | Longitudinal | | (Spiral) Equivalent Longitudinal. | | $2400 (f_e + 2.4 f_e')$ $3414 (f_e + 2.4 f_e')$ | | Kg. | | Lbs. | |
| | cm ² | in ² | kg. | lbs. | cm ² | in ² | cm ² | in ² | kg. | lbs. | Observed | Computed | Observed | Computed |
| V | 452 | 70.1 | 90100 | 198220 | 7.60 | 1.18 | 3.90 | 0.60 | 40700 | 89540 | 130800 | 142000 | 287760 | 312400 |
| VI | 442 | 68.5 | 88200 | 194040 | 7.60 | 1.18 | 7.78 | 1.21 | 63000 | 138600 | 151200 | 144000 | 332640 | 316800 |
| VII | 432 | 67.0 | 86200 | 189640 | 7.60 | 1.18 | 13.49 | 2.08 | 95900 | 210980 | 182100 | 176200 | 400620 | 387640 |

In spite of the defects in the specimens, the strength developed by them corresponded approximately with the results indicated by the formula, and exceeds them for the specimens with the least reinforcement.

Considère suggests the following lessons from the other results.

Pitch of the Spirals.

Specimens XIII and XIV, in which the pitch was exaggerated (80 and 120 mm.=3.15 and 4.72 in.), gave mediocre results.

Specimen XIII''', although showing an increase, did not develop the strength indicated by the formula. This circumstance appears to be ascribable to a wrong relationship between the diameters of the longitudinal rods and of the spiral reinforcement. This deficiency was not eliminated by a decrease in the pitch of the spirals.*



FIG. 72.—Failure from shear.
(Spiral broken.)



FIG. 73.—Spalling of the outer
concrete shell.

Relationship Between the Spirals and the Longitudinal Rods.

In specimens II, III, IV, VIII, IX, X, XI, and XII' the sectional area of the longitudinal rods was small, and the results were consequently indifferent; but the greater the total weight of spiral reinforcement, the higher were the results.

On the whole, the tests seem to prove that when the spirals are increased in strength, their pitch must be decreased, and the cross-section or number of the longitudinal rods must be increased; † for with increase in strength of spirals,

* Specimens XIII and XIV gave practically identical results. With the spiral reinforcement diameter and pitch as designed, longitudinal rods of larger diameter should apparently have been used in XIII'' and XIV''' to give results proportional to the corresponding tests of XII and XIV.—TRANS.

† In order to secure a consistent increase in supporting power.—TRANS.

the concrete is in a condition to resist a heavier pressure and its tendency to force its way out between the longitudinal rods also increases.

In planning the programme of tests of hooped concrete, a direct comparison was sought with the column tests conducted for the Reinforced Concrete Commission of the Jubiläumsstiftung der Deutscher Industrie (page 61), by making the cross-section of the octagon equal a square area 25 by 25 cm. (10 by 10 in. approx.), and by so arranging the spirals and longitudinal rods that in specimens II, III, IV, V, VI, and VII the amount of steel in the spirals was equal to that of the ties in the columns reinforced with 4 rods 15 mm. (0.59 in.) in diameter, and with spacings of 25 cm. (9.8 in.) 12.5 cm. (4.9 in.) and 6.25 cm. (2.45 in.).

While with the ordinary form of tie the increase in strength compared with non-reinforced concrete prisms (3 months old) amounted to 27 kg/cm² (384 lbs/in²), 36 kg/cm² (512 lbs/in²), and 64 kg/cm² (910 lbs/in²); with the employment of the same amount of steel in the form of spirals, and with 4 longitudinal rods only 7 mm. (0.28 in.) in diameter (5 to 6 months old) the increase was 26 kg/cm² (370 lbs/in²), 45 kg/cm² (640 lbs/in²), and 107 kg/cm² (1520 lbs/in²); and with eight rods 11 mm. (0.43 in.) in diameter, it was 93 kg/cm² (1320 lbs/in²), 97 kg/cm² (1380 lbs/in²), 148 kg/cm² (2100 lbs/in²).

In the last instance it is to be noted that the eight rods of 11 mm. (0.43 in.) diameter, have almost exactly the same section as the four 15 mm. (0.59 in.) rods in the last column test, so that the advantage of the spirals over the hooped results is an increase of strength of 66 kg/cm² (939 lbs/in²), 61 kg/cm² (868 lbs/in²), and 84 kg/cm² (1195 lbs/in²).

In the prisms VIII, IX, X, and XI the spirals were so designed that the quantity of steel in them was equal to that of both the ties and longitudinal rods of the column tests (page 61), and also so that a pitch of about one-seventh of the column diameter was obtained. In addition, for practical reasons, the spirals were held in position by four longitudinal rods, 7 mm. (0.28 in.) in diameter. The columns with four rods 20 mm. (0.79 in.) in diameter, and a 25 cm. (9.8 in.) spacing of ties, then had almost exactly the same amount of reinforcement as did the spirally reinforced prism IX, and also as did the column with four rods 15 mm. (0.59 in.) in diameter with a tie spacing of 12.5 cm. (4.9 in.). The increase in strength of the ordinary longitudinally reinforced columns, as compared with the non-reinforced specimens, according to Table XXIV, on page 63, amounted to

| | | | | |
|-------|-------|-------|-------|-----------------------------|
| 27 | 36 | 64 | 29 | 49 kg/cm ² |
| (384) | (512) | (910) | (412) | (796 lbs/in ²), |

and in the case of prisms VIII, IX, X, IX (again) and XI, according to Table XXVII, on page 70, it amounted to

| | | | | |
|-------|--------|--------|--------|------------------------------|
| 67 | 78 | 123 | 78 | 113 kg/cm ² |
| (952) | (1110) | (1745) | (1110) | (1605 lbs/in ²). |

If the ratio of the increase in strength shown by these two series of tests representing the two types of design, but employing for closer comparison only

those columns of the one kind which had the spacing of 25 cm. (9.8 in.), is computed, there is obtained

$$\frac{67}{27} = 2.48, \quad \frac{78}{29} = 2.69, \quad \frac{113}{49} = 2.31.$$

These results are in satisfactory agreement with the figure 2.4 assumed by Considère, which, therefore, expresses the superiority of reinforcement in the form of spirals over its value in the form of longitudinal rods.

The results obtained from specimens XII disclose the importance of combining with any spiral reinforcement a longitudinal reinforcement of about the same proportions.

CHAPTER VI
THEORY OF REINFORCED CONCRETE
SIMPLE BENDING

In homogeneous bodies possessing a constant modulus of deformation, equations of flexure can be derived on the assumption that sections which were plane before bending will be plane after bending. The question at once arises to what extent this assumption will apply to reinforced concrete bodies.

By experiments with homogeneous bodies of rectangular cross-section, the correctness of this assumption has been established within certain limits, but it owes its general acceptance to a demand for the greatest possible simplification of methods of calculation. Furthermore, it is known that this assumption of the conservation of plane sections is irreconcilable with the existence of shearing stresses, which generally tend to produce an S-shaped deformation of any right section. With equal reason, therefore, there can be assumed the conservation of plane sections in the flexure of reinforced concrete beams, and it is to be noted that the strength of the beam computed on page 29, on the basis of such plane sections, but constructed of a material possessing a variable modulus of deformation, coincides satisfactorily with that obtained by experiment.

If, therefore, in Fig. 74, AB represents the cross-section of a reinforced concrete beam, $A'B'$ is the curve of strain

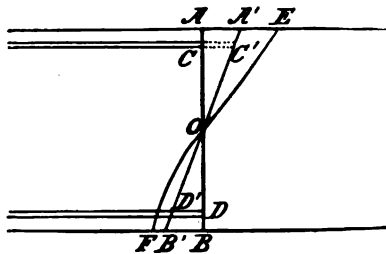

FIG. 74.

and the corresponding stress curve is represented by EOF . The latter is really a properly plotted stress-strain curve for concrete. The steel reinforcement must follow the deformation of the concrete. The upper reinforcement is consequently shortened an amount CC' , while the lower layer of steel is stretched an amount DD' . The corresponding steel stresses are proportional to these strains.

The distribution of stress in reinforced concrete, shown in Fig. 74, will occur only under very moderate loading, because the elasticity of concrete in tension is soon overcome. This condition of stress is designated Stage I. In calculating stresses in this stage, the lines OE and OF may be regarded as straight.

With increasing load, the full tensile strength of the concrete will be attained throughout the whole zone of tension, and if the great capacity of reinforced

concrete to stretch, observed by Considère, is assumed provisionally, then the distribution of stress under such conditions will resemble Fig. 75. This may be designated Stage II. According to Considère's tests, this second stage does not extend beyond the stress in the concrete corresponding to the strain of the reinforcement at its elastic limit. A continued increase in the load causes the elastic limit of the steel to be exceeded, the tensile strength of the concrete is no longer a factor, and finally a break occurs through a failure in the tensile strength of the steel or in the compressive strength of the concrete. This last condition of loading, the breaking stage, is designated Stage III. It is evident that in an exact theoretical study of the breaking stage, great difficulties are encountered; *since, then, the elastic conditions usually employed as the basis for calculations do not exist.*

With regard to Stage II, it must be noted that no certain dependence can be placed on the tensile strength of the concrete, partly because of irregularities in its composition, but especially because recent tests have shown that the stretch of concrete does not extend nearly to the strain of the steel at its elastic limit. Cracks in the concrete may therefore be expected in the latter part of Stage II. The early part of this condition of loading (without tension cracks in the concrete) may be called Stage II*a*, while the latter part may be Stage II*b* (with tensile cracks in the concrete and steel stress less than the elastic limit). The distribution of stress in these two sub-stages is shown in Figs. 75 and 76.

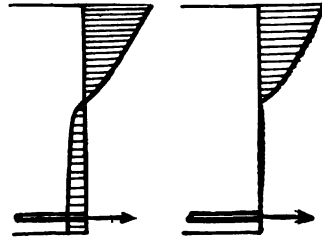

FIG. 75.

FIG. 76.

The question arises, which stress condition is to be made the basis from which to derive methods of calculation for practical purposes. When consideration is given to the fact that the object of every static calculation is not so much to ascertain the exact stresses in any structure resulting from a given load, but rather to secure an adequate degree of safety for the structure, then it must be concluded that attention should be given to the examination of the supporting power of reinforced concrete construction subject to bending—in Stage III (that of failure). This, however, can hardly be accomplished theoretically. Stage I must be excluded from consideration because it has already been passed even with perfectly safe loads. Stage II*a*, which has been recommended in several instances as a basis for calculations, should be excluded because of the uncertainty of Considère's tests, and also because the concrete has been shown to be subject to cracks, attributable, variously, to deficient manipulation, interruptions during the concreting process, to effects of temperature change, or to excessively rapid drying. Further, no more exact information is obtainable from this stage concerning the necessary amount of steel than is obtainable from Stages II*b* or III.

Stage II*b* is thus shown to be the only stress condition readily available for theoretical treatment and the one which most clearly shows the required amount of reinforcement. Moreover, the method derived from it has the great advantage of simplicity, and it can be adapted to Stage III, so that safe stresses can be selected which bear a proper relation to the results of ultimate bending tests.

In making designs based on Stage IIb instead of on the rupture stage, no greater error is committed than is made in every calculation of ordinary timber or steel construction, in which Navier's theory of flexure is almost always employed, even though it is not applicable at the point of rupture.

There follow a few methods of calculating reinforced concrete structures subjected to bending stress. They have been developed on the basis of Stage IIb. In them it is assumed that, after deformation, the strained steel sections remain in the same planes with the corresponding compressed concrete sections. The tensile strength of the concrete is consequently ignored.

Rectangular Sections—Slabs

1. With rectangular cross-sections the calculations can be made with the aid of the stress-strain curve exactly as has already been described for non-reinforced concrete beams.

In Fig. 77 the line OE represents the variation in compressive stress. The branch for tensile stresses is omitted, and its place is taken by the tension sur-

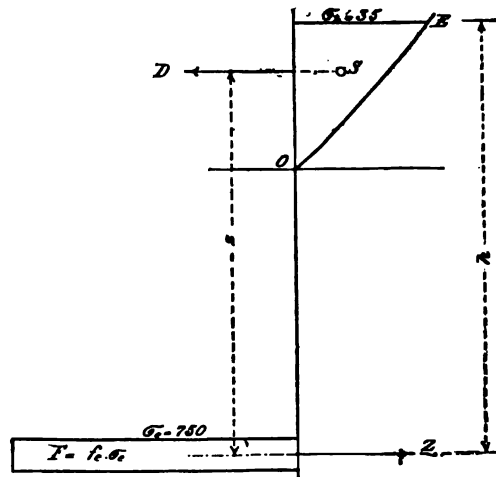

FIG. 77.

face of the reinforcement. Calling the width of cross-section equal to unity, and assuming σ_b and σ_s definite safe stresses for the concrete and the steel respectively, then the stress surface for the concrete is definitely determined, and also the position of the reinforcement. The tension surface of the steel is a long, narrow rectangle. In simple flexure, there are present no exterior longitudinal force components, and consequently the tensile and compressive forces must balance in each section. Or, the area of the compression surface must be equal to the rectangle of the tensile stress. If the distance of the centroid of the reinforcement from the upper edge is called h , then f_c can be expressed as a function of h , σ_b , and the moment M . The latter is equal to the area of the compression surface multiplied by the distance of its centroid from the rein-

forcement, and consequently f_c will be a function of h^2 ; h may be called the useful height of section. Determining dimensions of members according to this method is easy, whereas complicated trial calculations are necessary to ascertain the stresses in an existing structure.

This method, in connection with the stress-strain curves shown on page 24, gives the following results: With a 1:4 mixture with 14 per cent of water, if F_c represents the section of the reinforcement in square centimeters per meter width of slab (also square inches per foot width), and M is computed for the same width in centimeter-kilograms (inch-pounds) with $\sigma_b=40 \text{ kg/cm}^2$ (569 lbs/in²), $\sigma_s=1000 \text{ kg/cm}^2$ (14,220 lbs/in²), $E_c=2,160,000 \text{ kg/cm}^2$ (30,720,000 lbs/in²).

$$h = 0.0407\sqrt{M} \text{ centimeters per meter width of } M;$$

$$*(h = 0.0312\sqrt{M} \text{ inches per ft. width of } M);$$

$$F_c = 0.0277\sqrt{M} \text{ square centimeters per meter width};$$

$$*(F_c = 0.00255\sqrt{M} \text{ square inches per ft. width}).$$

The thickness d of the slab is to be taken 1.5 to 2.0 cm. (0.6 to 0.8 in.) greater than the calculated useful height h , the bottom face of the concrete being lowered to that extent.

It is further to be noted that this method also allows account to be taken of the tensile strength of the concrete.

2. The same general method may be followed along strictly analytical lines, by employing the exponential law. The conservation of plane sections is expressed in the nomenclature of Fig. 78, by the proportion

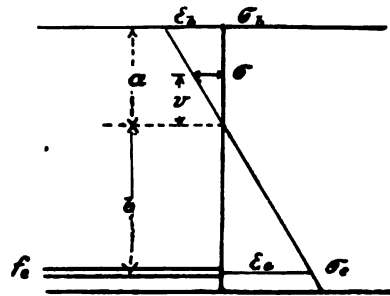

FIG. 78.

$$\frac{\epsilon_b}{a} = \frac{\epsilon_s}{b},$$

whence

$$\epsilon_b = \frac{a}{b} \epsilon_s. \quad \text{Also } \epsilon_s = \frac{\sigma_s}{E}.$$

Now, according to the exponential law

$$\epsilon_b = \alpha \sigma_b^m,$$

* These values are for unit stresses of 569 and 14,220 lbs. in concrete and steel respectively, and for a moment equal to M in-lbs. per foot width in English units, while the formula in metric units is for M kg-cm per meter width.—TRANS.

whence

$$\alpha \sigma_b^m = \frac{a}{b} \frac{\sigma_e}{E},$$

wherein E represents the modulus of elasticity of steel.

Now,

$$b = h - a,$$

from which $(h - a) \alpha \sigma_b^m = a \frac{\sigma_e}{E}$,

whence

$$a = \frac{h \alpha \sigma_b^m}{\alpha \sigma_b^m + \frac{\sigma_e}{E}}.$$

The moment M is:

$$M = \int_0^{\sigma_b} \sigma dv (b + v).$$

Now,

$$\sigma^m : \sigma_b^m :: v : a,$$

so that

$$v = \frac{a \sigma^m}{\sigma_b^m},$$

and from differentiation

$$dv = \frac{a m}{\sigma_b^m} \sigma^{m-1} d\sigma.$$

Therefore,

$$\begin{aligned} M &= \int_0^{\sigma_b} \frac{\sigma a m}{\sigma_b^m} \sigma^{m-1} d\sigma \left(b + \frac{a \sigma^m}{\sigma_b^m} \right) \\ &= \frac{a b m}{\sigma_b^m} \int_0^{\sigma_b} \sigma^m d\sigma + \frac{a^2 m}{\sigma_b^{2m}} \int_0^{\sigma_b} \sigma^{2m} d\sigma \\ &= a b \frac{m}{m+1} \sigma_b + a^2 \frac{m}{2m+1} \sigma_b. \end{aligned}$$

After substituting the values of a and b , given above,

$$M = \frac{m}{m+1} \frac{h^2 \sigma_b^{m+1} E}{\left(\frac{1}{\alpha} \sigma_e + \sigma_b^m E \right)^2} \left(\frac{(m+1) \sigma_b^m E}{2m+1} + \frac{1}{\alpha} \sigma_e \right).$$

The area of steel, f_e , for unit width of slab, is given by the equation

$$\begin{aligned} f_e &= \frac{1}{\sigma_e} \int_0^{\sigma_b} \sigma \, dv \\ &= \frac{1}{\sigma_e} \int_0^{\sigma_b} \frac{\sigma \, a \, m \, \sigma^{m-1}}{\sigma_b^m} \, d\sigma \\ &= \frac{1}{\sigma_e} \frac{a \, m}{m+1} \frac{\sigma_b^{m+1}}{\sigma_b^m} \\ &= \frac{1}{\sigma_e} \frac{h \, \alpha \, \sigma_b^{m+1}}{\left(\alpha \sigma_b^m + \frac{\sigma_e}{E} \right)} \frac{m}{m+1}. \end{aligned}$$

If h from the equation for M is substituted herein, there results for unit width of slab

$$f_e = \frac{1}{\sigma_e} \sqrt{\frac{m}{m+1} \frac{\sigma_b^{m+1} E M}{\frac{m+1}{2m+1} \sigma_b E + \frac{1}{\alpha} \sigma_b^m}}$$

If values of σ_b and σ_e are assumed, the equations given above may be employed in designing slabs. In this case with $\alpha = \frac{1}{230,000}$, $m = 1.17$, $\epsilon_b = \frac{\sigma_b^{1.17}}{230,000}$, $E = 2,160,000$, $\sigma_b = 40 \text{ kg/cm}^2$, and $\sigma_e = 1000 \text{ kg/cm}^2$, if F_e represents the section of the reinforcement for one meter breadth of slab, and further if M is calculated for the same breadth in centimeter-kilograms.

- $h = 0.0363 \sqrt{M}$ centimeters for M on meter width;
- * ($h = 0.0278 \sqrt{M}$ inches for M on foot width);
- $F_e = 0.0324 \sqrt{M}$ square centimeters for M on meter width;
- * ($F_e = 0.00298 \sqrt{M}$ square inches for M on ft. width).

The thickness of the slab is to be increased 1.5 to 2 cm. (0.6 to 0.8 in.) over the value of h , this increase being made below the centroid of the reinforcement.

3. While the two methods above described permit only of designing—which is most important for the engineer—the following method may be employed to investigate the stresses in completed or completely designed reinforced concrete slabs. It is contained in the “Leitsätze”

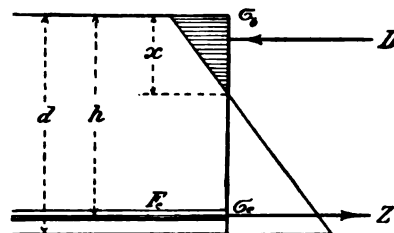

FIG. 79.

of the Verbands Deutsche Architekten- und Ingenieurvereine, and the Deutschen

* See foot-note, page 77.

Betonvereins, of 1904, and is also included in the Prussian Ministerial "Regulations" of 1904 and 1907.

Here, instead of the exponential law, is employed the proportionality between the tensile and compressive stresses of the concrete, while the tensile strength is again ignored. If a constant modulus of elasticity of concrete E_b is assumed, and the distance of the neutral plane from the top of the slab is called x , then (see Fig. 79),

$$Z = D$$

$$M = D \left(h - \frac{x}{3} \right).$$

Further, the strains are in the proportion

$$\frac{\sigma_b}{E_b} : x = \frac{\sigma_e}{E_e} : (h - x).$$

If b represents the assumed breadth of the section, and F_e the total area of the tension reinforcement in the same breadth, then

$$\frac{\sigma_b b x}{2} = \sigma_e F_e = D,$$

whence

$$\sigma_b = \frac{2 \sigma_e F_e}{b x}.$$

Substituting this value in the proportion above, gives

$$\frac{2 \sigma_e F_e}{b x E_b} : x = \frac{\sigma_e}{E_e} : (h - x),$$

whence

$$\frac{x^2}{E_e} = \frac{2 F_e}{b E_b} (h - x).$$

With $\frac{E_e}{E_b} = n$, this may be transformed into the quadratic equation

$$x^2 + 2 \frac{F_e}{b} n x = 2 \frac{F_e}{b} n h,$$

from which

$$x = \frac{n F_e}{b} \left[-1 + \sqrt{1 + \frac{2 b h}{n F_e}} \right].$$

With the value of x from this equation, there may be found

$$Z = D = \frac{M}{h - \frac{x}{3}},$$

and the maximum stress on the concrete

$$\sigma_b = \frac{2D}{bx} = \frac{2M}{bx\left(h - \frac{x}{3}\right)},$$

and on the steel

$$\sigma_e = \frac{Z}{F_e} = \frac{M}{F_e\left(h - \frac{x}{3}\right)}.$$

The position of the neutral axis is determined by the condition that it must pass through the centroid of the effective stress surface, in which the area of the reinforcement has been replaced by a concrete area n -times larger than that of the steel. The neutral axis thus forms the lower limit of the compressed portion of the concrete section.

This gives as the equation for the statical moment of the effective areas with respect to the neutral axis

$$bx \frac{x}{2} - n F_e (h - x) = 0,$$

from which follows the quadratic equation

$$x^2 + 2 \frac{F_e}{b} n x = 2 \frac{F_e}{b} n h.$$

A formula may also be deduced in terms of the *unit stresses*.

From the proportion

$$\frac{\sigma_b}{E_b} : x = \frac{\sigma_e}{E_e} : (h - x),$$

there follows

$$x = \frac{h \sigma_b n}{\sigma_e + n \sigma_b}.$$

The moment M for breadth b is

$$\begin{aligned} M &= \frac{b \sigma_b x}{2} \left(h - \frac{x}{3} \right) \\ &= \frac{b h \sigma_b^2 n}{2(\sigma_e + n \sigma_b)} \left(h - \frac{h \sigma_b n}{3(\sigma_e + n \sigma_b)} \right) \\ &= \frac{b h^2 \sigma_b^2 n}{6(\sigma_e + n \sigma_b)^2} (3\sigma_e + 2n \sigma_b). \\ h &= \frac{\sigma_e + n \sigma_b}{\sigma_b} \sqrt{\frac{6M}{n(3\sigma_e + 2n \sigma_b) b}} \end{aligned}$$

The total area of steel for breadth b is

$$F_s = \frac{\sigma_b x b}{2\sigma_s},$$

or

$$F_s = \frac{b h \sigma_b^2 n}{2 \sigma_s (\sigma_s + n \sigma_b)}.$$

If the safe unit stresses adopted in the "Leitsätze" are employed, $\sigma_b = 40$ kg/cm² (569 lbs/in²), $\sigma_s = 1000$ kg/cm² (14,220 lbs/in²), if also $b = 100$ cm. (39.4 in.) and $n = 15$, there results

$$h = 0.0390 \sqrt{M} \text{ centimeters};$$

$$F_s = 0.0293 \sqrt{M} \text{ square centimeters};$$

$$*(h = 0.02993 \sqrt{M} \text{ inch for one foot width of } M);$$

$$*(F_s = 0.002696 \sqrt{M} \text{ square inches for one foot width of } M).$$

When employing the safe stresses $\sigma_b = 40$, and $\sigma_s = 1000$, the area of reinforcement bears to h the ratio

$$F_s = \frac{0.0293}{0.0390} h = 0.750 h \text{ (metric);}$$

$$F_s = \frac{0.002696}{0.02993} h = 0.09 h \text{ (English).}$$

If this ratio is exceeded, the steel cannot be fully utilized, because then the concrete would be over-stressed in compression. Reinforcement of this character would therefore be impracticable.

With variously assumed values of σ_b and σ_s the distance x of the neutral axis from the upper edge of section may be expressed in terms of h , and with $n = 15$, and $b = 100$ cm., the values in Table XXIX are obtained.

The figures in heavy type represent stresses adopted in the "Leitsätze" and the Prussian "Regulations." With $\sigma_b = 40$, and $\sigma_s = 1000$ kg/cm² (569 and 14,220 lbs/in², respectively), the neutral axis is located at $\frac{3}{8}$ of the height, and the arm of the couple formed by the tensile and compressive stresses is $\frac{7}{8}h$. These results are of great value in preliminary calculations and rough estimates, since with moderate concrete stresses these quantities do not vary much.

If, for instance, a continuous roof slab is to be designed, of which the greatest moment is 70,000 cm.-kg. (60,630 in.-lbs.), there must first be determined the thickness and steel section at points of maximum moment (by means of Table XX, for instance), and then the section of steel at the points of minimum moment by the formula

$$F_s = \frac{M}{\sigma_s \frac{7}{8} h}.$$

* See foot-note, page 77.

TABLE XXIX
BEAM ELEMENTS FOR VARIOUS UNIT STRESSES

| σ_c | | σ_s | | $h/\sqrt{M^*}$ | | $F_e/\sqrt{M^*}$ | | x/h | $(\frac{h-x}{3})/h$ |
|--------------------|---------------------|--------------------|---------------------|-----------------------|------------------------|-----------------------------------|------------------------------------|-------|---------------------|
| kg/cm ² | lbs/in ² | kg/cm ² | lbs/in ² | cm. for M per m. | in. for M per ft. | cm ² for M per m. | in ² for M per ft. | | |
| 30 | 427 | 750 | 10673 | 0.0451 | 0.0348 | 0.0338 | 0.00314 | 0.375 | 0.875 |
| 35 | 498 | 750 | 10673 | 0.0401 | 0.0307 | 0.0385 | 0.00354 | 0.412 | 0.863 |
| 40 | 569 | 750 | 10673 | 0.0363 | 0.0279 | 0.0430 | 0.00394 | 0.444 | 0.852 |
| 45 | 640 | 750 | 10673 | 0.0334 | 0.0256 | 0.0474 | 0.00432 | 0.474 | 0.842 |
| 50 | 712 | 750 | 10673 | 0.0310 | 0.0238 | 0.0517 | 0.00476 | 0.500 | 0.833 |
| 30 | 427 | 800 | 11376 | 0.0459 | 0.0353 | 0.0309 | 0.00284 | 0.360 | 0.880 |
| 35 | 498 | 800 | 11376 | 0.0408 | 0.0314 | 0.0353 | 0.00325 | 0.396 | 0.868 |
| 40 | 569 | 800 | 11376 | 0.0367 | 0.0282 | 0.0397 | 0.00367 | 0.429 | 0.857 |
| 45 | 640 | 800 | 11376 | 0.0339 | 0.0261 | 0.0436 | 0.00402 | 0.458 | 0.843 |
| 50 | 712 | 800 | 11376 | 0.0314 | 0.0241 | 0.0475 | 0.00437 | 0.484 | 0.839 |
| 30 | 427 | 900 | 12798 | 0.0474 | 0.0364 | 0.0264 | 0.00243 | 0.333 | 0.889 |
| 35 | 498 | 900 | 12798 | 0.0420 | 0.0323 | 0.0301 | 0.00277 | 0.368 | 0.877 |
| 40 | 569 | 900 | 12798 | 0.0380 | 0.0298 | 0.0337 | 0.00310 | 0.400 | 0.867 |
| 45 | 640 | 900 | 12798 | 0.0348 | 0.0268 | 0.0373 | 0.00344 | 0.429 | 0.857 |
| 50 | 712 | 900 | 12798 | 0.0322 | 0.0248 | 0.0407 | 0.00374 | 0.455 | 0.848 |
| 20 | 299 | 1000 | 14220 | 0.0685 | 0.0526 | 0.0158 | 0.00145 | 0.230 | 0.923 |
| 25 | 356 | 1000 | 14220 | 0.0568 | 0.0436 | 0.0193 | 0.00178 | 0.273 | 0.909 |
| 30 | 427 | 1000 | 14220 | 0.0490 | 0.0376 | 0.0228 | 0.00210 | 0.310 | 0.896 |
| 35 | 498 | 1000 | 14220 | 0.0433 | 0.0333 | 0.0261 | 0.00241 | 0.344 | 0.885 |
| 40 | 569 | 1000 | 14220 | 0.0390 | 0.0299 | 0.0293 | 0.00270 | 0.375 | 0.875 |
| 45 | 640 | 1000 | 14220 | 0.0357 | 0.0274 | 0.0324 | 0.00301 | 0.403 | 0.866 |
| 50 | 712 | 1000 | 14220 | 0.0330 | 0.0253 | 0.0354 | 0.00326 | 0.429 | 0.857 |
| 30 | 427 | 1200 | 17076 | 0.0519 | 0.0398 | 0.0177 | 0.00164 | 0.273 | 0.909 |
| 35 | 498 | 1200 | 17076 | 0.0457 | 0.0357 | 0.0203 | 0.00188 | 0.304 | 0.898 |
| 40 | 569 | 1200 | 17076 | 0.0410 | 0.0315 | 0.0228 | 0.00210 | 0.333 | 0.889 |
| 45 | 640 | 1200 | 17076 | 0.0375 | 0.0288 | 0.0253 | 0.00234 | 0.360 | 0.880 |
| 50 | 712 | 1200 | 17076 | 0.0345 | 0.0255 | 0.0277 | 0.00255 | 0.385 | 0.872 |

Exact calculations will give stresses slightly smaller than $\sigma_c=1000$ kg/cm² (14,220 lbs/in²), so that a somewhat greater factor of safety is secured.

If an existing design is to be checked, the equations of page 80 must be employed, or Table XXX used. In the latter case it is only necessary to find the assumed section of reinforcement F_e in terms of the useful area (for instance, $F_e = \mu b h$, or $\mu = \frac{F_e}{b h}$) and then the values of x , σ_b , and σ_c may be found immediately.

If the reinforcement is taken at approximately 0.79 per cent of the useful cross-section, the stress of the extreme layer σ_b will be equal to that in a homogeneous section, i.e., $\sigma_b = \frac{M}{\frac{1}{3} b h^2}$. A value of 0.75 per cent also approximates

* M is measured in kg.-cm. in one column and in in.-lbs. in the other, but in each case the coefficients are computed for the same numerical value of M .—TRANS.

the customary amount of reinforcement employed, so that σ_b may be computed in this simple manner with sufficient accuracy.

TABLE XXX
BEAM ELEMENTS FOR VARIOUS PERCENTAGES OF REINFORCEMENT

| μ Per Cent. | μ | $\frac{x}{h}$ | $\frac{\sigma_b}{M/bk^3}$ | $\frac{\sigma_e}{\sigma_b}$ | $\frac{\sigma_e}{M/bk^3}$ |
|--------------------|--------|---------------|---------------------------|-----------------------------|---------------------------|
| 1.00 | 0.0100 | 0.418 | 5.559 | 20.9 | 116 |
| 0.95 | 0.0095 | 0.410 | 5.650 | 21.6 | 122 |
| 0.90 | 0.0090 | 0.402 | 5.747 | 22.3 | 128 |
| 0.85 | 0.0085 | 0.393 | 5.852 | 23.1 | 135 |
| 0.80 | 0.0080 | 0.384 | 5.968 | 24.0 | 143 |
| 0.75 | 0.0075 | 0.375 | 6.096 | 25.0 | 152 |
| 0.70 | 0.0070 | 0.365 | 6.236 | 26.1 | 163 |
| 0.65 | 0.0065 | 0.355 | 6.394 | 27.3 | 174 |
| 0.60 | 0.0060 | 0.344 | 6.572 | 28.6 | 188 |
| 0.55 | 0.0055 | 0.332 | 6.774 | 30.2 | 204 |
| 0.50 | 0.0050 | 0.320 | 7.006 | 32.0 | 224 |
| 0.45 | 0.0045 | 0.306 | 7.278 | 34.0 | 247 |
| 0.40 | 0.0040 | 0.292 | 7.597 | 36.4 | 277 |
| 0.35 | 0.0035 | 0.276 | 7.985 | 39.4 | 315 |
| 0.30 | 0.0030 | 0.258 | 8.471 | 43.1 | 365 |
| 0.25 | 0.0025 | 0.239 | 9.096 | 47.8 | 435 |
| 0.20 | 0.0020 | 0.217 | 9.945 | 54.2 | 539 |

The values of h and F_e for various moments are contained in Table XXX.

Commencing on page 88 are to be found some examples of computations in full which were given in the "Leitsätze."

In the "Zentralblatt der Bauverwaltung" for 1886 is to be found an approximate rule devised by Könen, which is frequently employed in determining the necessary section of reinforcement. It makes the inaccurate assumption that the neutral plane is at the center of the slab, and that the distance between the centroids of the compression and tension areas is $\frac{3}{4}d$, so that the area of steel is given by the formula

$$F_e = \frac{M}{\sigma_e \frac{3}{4}d}$$

The distance $\frac{3}{4}d$ is correct in accordance with what is shown on page 83, if

$$\frac{3}{4}d = 0.875h,$$

or

$$d = \frac{4}{3}h.$$

This equation will usually hold for slabs of thicknesses, $d=6$ to 12 cm. (2.4 to 4.7 ins.) so that in such cases, approximate calculations can be made with $\frac{3}{4}d$ in place of $\frac{4}{3}h$.

Concerning tests made with rectangular slabs, see page 90.

TABLE XXXI
 BEAM ELEMENTS FOR VARIOUS MOMENTS
 $\sigma_b = 40 \text{ kg/cm}^2$ (569 lbs/in²), $\sigma_e = 1000 \text{ kg/cm}^2$ (14220 lbs/in²)

| M for Meter Width. | | h | | d | | F_e | | Corresponding M' per ft. width. in.-lbs. |
|----------------------|----------|------------------------------|------------------------------|------|------|--|--|--|
| cm.-kg | in.-lbs. | cm. for M per meter width. | in. for M' per foot width. | cm. | in. | cm ² for M per meter width. | in ² for M' per foot width. | |
| 10000 | 8661 | 3.90 | 1.54 | 5.0 | 1.97 | 2.93 | 0.139 | 2640 |
| 11000 | 9428 | 4.09 | 1.61 | 5.0 | 1.97 | 3.97 | 0.145 | 2904 |
| 12000 | 10394 | 4.27 | 1.68 | 5.5 | 2.17 | 3.20 | 0.151 | 3168 |
| 13000 | 11260 | 4.44 | 1.74 | 5.5 | 2.17 | 3.33 | 0.158 | 3432 |
| 14000 | 12126 | 4.62 | 1.81 | 6.0 | 2.36 | 3.46 | 0.164 | 3696 |
| 15000 | 12992 | 4.78 | 1.87 | 6.0 | 2.36 | 3.58 | 0.169 | 3960 |
| 16000 | 13858 | 4.94 | 1.94 | 6.0 | 2.36 | 3.70 | 0.175 | 4224 |
| 17000 | 14724 | 5.09 | 2.02 | 6.5 | 2.65 | 3.81 | 0.181 | 4488 |
| 18000 | 15590 | 5.24 | 2.08 | 6.5 | 2.65 | 3.93 | 0.186 | 4752 |
| 19000 | 16456 | 5.38 | 2.13 | 6.5 | 2.65 | 4.03 | 0.191 | 5016 |
| 20000 | 17321 | 5.52 | 2.17 | 6.5 | 2.65 | 4.14 | 0.196 | 5280 |
| 22000 | 19054 | 5.72 | 2.25 | 7.0 | 2.76 | 4.30 | 0.202 | 5808 |
| 24000 | 20786 | 6.04 | 2.38 | 7.0 | 2.76 | 4.53 | 0.215 | 6336 |
| 26000 | 22518 | 6.29 | 2.48 | 7.5 | 2.95 | 4.71 | 0.223 | 6864 |
| 28000 | 24251 | 6.53 | 2.57 | 8.0 | 3.15 | 4.91 | 0.233 | 7392 |
| 30000 | 25984 | 6.75 | 2.66 | 8.0 | 3.15 | 5.06 | 0.240 | 7920 |
| 32000 | 27716 | 6.98 | 2.76 | 8.5 | 3.35 | 5.22 | 0.247 | 8448 |
| 34000 | 29448 | 7.20 | 2.84 | 8.5 | 3.35 | 5.39 | 0.255 | 8976 |
| 36000 | 31180 | 7.40 | 2.91 | 8.5 | 3.35 | 5.54 | 0.262 | 9504 |
| 38000 | 32913 | 7.61 | 3.00 | 9.0 | 3.54 | 5.70 | 0.270 | 10032 |
| 40000 | 34645 | 7.80 | 3.07 | 9.0 | 3.54 | 5.85 | 0.277 | 10560 |
| 42000 | 36377 | 8.00 | 3.15 | 9.0 | 3.54 | 6.00 | 0.284 | 11088 |
| 44000 | 38109 | 8.19 | 3.23 | 9.5 | 3.74 | 6.13 | 0.290 | 11616 |
| 46000 | 39832 | 8.37 | 3.30 | 9.5 | 3.74 | 6.28 | 0.297 | 12144 |
| 48000 | 41574 | 8.56 | 3.37 | 10.0 | 3.94 | 6.42 | 0.304 | 12672 |
| 50000 | 43307 | 8.74 | 3.44 | 10.0 | 3.94 | 6.55 | 0.310 | 13200 |
| 55000 | 47637 | 9.15 | 3.60 | 10.5 | 4.13 | 6.86 | 0.324 | 14520 |
| 60000 | 51968 | 9.56 | 3.76 | 11.0 | 4.33 | 7.16 | 0.339 | 15840 |
| 65000 | 56298 | 9.94 | 3.91 | 11.5 | 4.54 | 7.45 | 0.352 | 17160 |
| 70000 | 60630 | 10.32 | 4.06 | 12.0 | 4.72 | 7.74 | 0.366 | 18480 |
| 75000 | 64959 | 10.68 | 4.19 | 12.0 | 4.72 | 8.01 | 0.379 | 19800 |
| 80000 | 69291 | 11.05 | 4.34 | 12.5 | 4.92 | 8.29 | 0.392 | 21120 |
| 85000 | 73620 | 11.38 | 4.46 | 12.5 | 4.92 | 8.53 | 0.403 | 22440 |
| 90000 | 77952 | 11.70 | 4.60 | 13.0 | 5.12 | 8.75 | 0.414 | 23760 |
| 95000 | 82282 | 12.04 | 4.74 | 13.5 | 5.72 | 9.03 | 0.427 | 25080 |
| 100000 | 86614 | 12.35 | 4.85 | 13.5 | 5.72 | 9.27 | 0.438 | 26400 |
| 105000 | 90944 | 12.67 | 4.97 | 14.0 | 5.51 | 9.50 | 0.449 | 27720 |
| 110000 | 94280 | 12.90 | 5.07 | 14.0 | 5.51 | 9.68 | 0.459 | 29040 |
| 115000 | 98611 | 13.23 | 5.21 | 14.5 | 5.71 | 9.92 | 0.469 | 30360 |
| 120000 | 103940 | 13.52 | 5.32 | 15.0 | 5.90 | 10.14 | 0.479 | 31680 |
| 125000 | 108270 | 13.80 | 5.43 | 15.5 | 6.18 | 10.35 | 0.489 | 33000 |
| 130000 | 112600 | 14.05 | 5.53 | 15.5 | 6.18 | 10.54 | 0.498 | 34320 |
| 135000 | 116930 | 14.33 | 5.64 | 16.0 | 6.30 | 10.75 | 0.508 | 35640 |
| 140000 | 121260 | 14.60 | 5.75 | 16.0 | 6.30 | 10.95 | 0.518 | 36960 |
| 145000 | 125591 | 14.87 | 5.85 | 16.5 | 6.49 | 11.15 | 0.528 | 38280 |

TABLE XXXI—Continued

$$\sigma_b = 40 \text{ kg/cm}^2 (56.9 \text{ lbs/in}^2), \quad \sigma_e = 1000 \text{ kg/cm}^2 (14220 \text{ lbs/in}^2)$$

| M for Meter Width. | | h | | d | | A _s | | Corresponding M' per ft. width. in.-lbs. |
|--------------------|----------|----------------------------|----------------------------|------|-------|--|--|--|
| cm. = k. | in.-lbs. | cm. for M per meter width. | in. for M' per foot width. | cm. | in. | cm ² for M per meter width. | in ² for M' per foot width. | |
| 150000 | 129920 | 15.13 | 5.96 | 16.5 | 6.49 | 11.35 | 0.538 | 39600 |
| 160000 | 138580 | 15.60 | 6.14 | 17.0 | 6.69 | 11.70 | 0.554 | 42240 |
| 170000 | 147240 | 16.10 | 6.34 | 18.0 | 7.09 | 12.07 | 0.571 | 44880 |
| 180000 | 155900 | 16.60 | 6.54 | 18.5 | 7.29 | 12.45 | 0.589 | 47520 |
| 190000 | 164560 | 17.00 | 6.69 | 19.0 | 7.48 | 12.75 | 0.603 | 50160 |
| 200000 | 173210 | 17.45 | 6.87 | 19.5 | 7.68 | 13.09 | 0.619 | 52800 |
| 210000 | 181870 | 17.87 | 7.04 | 20.0 | 7.87 | 13.45 | 0.636 | 55440 |
| 220000 | 190540 | 18.30 | 7.21 | 20.5 | 8.07 | 13.74 | 0.649 | 58080 |
| 230000 | 199200 | 18.71 | 7.37 | 21.0 | 8.27 | 14.06 | 0.664 | 60720 |
| 240000 | 207860 | 19.12 | 7.53 | 21.5 | 8.46 | 14.35 | 0.678 | 63360 |
| 250000 | 216520 | 19.50 | 7.68 | 22.0 | 8.66 | 14.65 | 0.692 | 66000 |
| 260000 | 225180 | 19.89 | 7.83 | 22.5 | 8.86 | 14.95 | 0.707 | 68640 |
| 270000 | 233840 | 20.26 | 7.98 | 23.0 | 9.05 | 15.23 | 0.720 | 71280 |
| 280000 | 242510 | 20.64 | 8.13 | 23.0 | 9.05 | 15.51 | 0.733 | 73920 |
| 290000 | 251170 | 21.00 | 8.27 | 23.5 | 9.25 | 15.70 | 0.742 | 76560 |
| 300000 | 259840 | 21.36 | 8.41 | 24.0 | 9.45 | 16.05 | 0.759 | 79200 |
| 320000 | 277160 | 22.06 | 8.69 | 24.5 | 9.65 | 16.58 | 0.784 | 84480 |
| 340000 | 294480 | 22.74 | 8.95 | 25.0 | 9.84 | 17.08 | 0.807 | 89760 |
| 360000 | 311800 | 23.40 | 9.21 | 26.0 | 10.24 | 17.58 | 0.831 | 95040 |
| 380000 | 329130 | 24.04 | 9.47 | 26.5 | 10.43 | 18.06 | 0.853 | 100320 |
| 400000 | 346450 | 24.67 | 9.71 | 27.0 | 10.63 | 18.54 | 0.876 | 105600 |
| 420000 | 363770 | 25.27 | 9.95 | 28.0 | 11.02 | 18.99 | 0.895 | 110880 |
| 440000 | 381090 | 25.87 | 10.19 | 28.5 | 11.22 | 19.44 | 0.919 | 116160 |
| 460000 | 398320 | 26.45 | 10.41 | 29.0 | 11.42 | 19.87 | 0.939 | 121440 |
| 480000 | 415740 | 27.02 | 10.64 | 29.5 | 11.61 | 20.30 | 0.959 | 126720 |
| 500000 | 433070 | 27.58 | 10.86 | 30.0 | 11.81 | 20.72 | 0.979 | 132000 |
| 550000 | 476370 | 28.92 | 11.39 | 31.5 | 12.40 | 21.73 | 1.027 | 145200 |
| 600000 | 519680 | 30.21 | 11.89 | 33.0 | 12.99 | 22.70 | 1.073 | 158400 |
| 650000 | 562980 | 31.44 | 12.38 | 34.0 | 13.38 | 23.63 | 1.117 | 171600 |
| 700000 | 606300 | 32.64 | 12.85 | 35.0 | 13.78 | 24.52 | 1.159 | 184800 |
| 750000 | 649590 | 33.76 | 13.29 | 36.5 | 14.37 | 25.39 | 1.200 | 198000 |
| 800000 | 692910 | 34.88 | 13.73 | 37.5 | 14.76 | 26.20 | 1.238 | 211200 |
| 850000 | 736200 | 35.95 | 14.15 | 38.5 | 15.16 | 27.01 | 1.276 | 224400 |
| 900000 | 779520 | 37.01 | 14.57 | 39.5 | 15.55 | 27.79 | 1.313 | 237600 |
| 950000 | 822820 | 38.01 | 14.96 | 40.5 | 15.94 | 28.55 | 1.349 | 250800 |
| 1000000 | 866140 | 39.00 | 15.35 | 42.0 | 16.53 | 29.30 | 1.385 | 264000 |
| 1100000 | 942800 | 40.90 | 16.10 | 43.5 | 17.12 | 30.62 | 1.447 | 290400 |
| 1200000 | 1039400 | 42.72 | 16.82 | 45.5 | 17.91 | 32.10 | 1.517 | 316800 |
| 1300000 | 1126000 | 44.46 | 17.50 | 47.5 | 18.70 | 33.39 | 1.578 | 343200 |
| 1400000 | 1212600 | 46.14 | 18.17 | 49.0 | 19.29 | 34.65 | 1.637 | 369600 |
| 1500000 | 1299200 | 47.77 | 18.78 | 50.5 | 19.88 | 35.86 | 1.695 | 396000 |
| 1600000 | 1385800 | 49.32 | 19.42 | 52.0 | 20.47 | 37.02 | 1.749 | 422400 |

RECTANGULAR SECTION, DOUBLE REINFORCEMENT

Where reinforcement is placed within the zone of compression but is of such size as to be far subordinate in effect to the concrete, and with the assumption of a constant modulus of elasticity, calculations may be carried out according to the method which follows and which corresponds with process 3, last preceding.

With the nomenclature of Fig. 8o there is obtained for simple flexure, from the equality of tensile and compressive stresses in the cross-section, the equation:

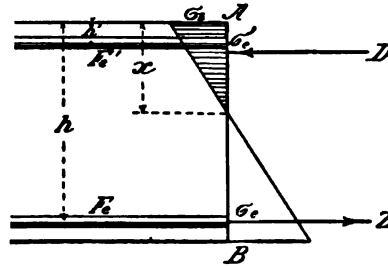

FIG. 8o.

$$F_e \sigma_e = \frac{b}{2} \sigma_b x + F_e' \sigma_e', \dots \dots \dots (1)$$

wherein the small reduction in the area of the concrete by the steel section F_e is ignored.

Further, the following relations must hold:

$$\frac{\sigma_b}{E_b} : \frac{\sigma_e}{E_e} = x : (h - x) \dots \dots \dots (2)$$

$$\frac{\sigma_b}{E_b} : \frac{\sigma_e'}{E_e} = x : (x - h') \dots \dots \dots (3)$$

$$M = \sigma_b \frac{x b}{2} \left(h - \frac{x}{3} \right) + F_e' \sigma_e' (h - h') \dots \dots \dots (4)$$

These four equations suffice for the determination of the four unknowns x , σ_e , σ_e' , σ_b , if the remaining quantities are known. From (2) and (3) with $\frac{E_e}{E_b} = n$ there results

$$\sigma_e = \frac{\sigma_b (h - x) n}{x} \dots \dots \dots (5)$$

$$\sigma_e' = \frac{\sigma_b (x - h') n}{x} \dots \dots \dots (6)$$

When these values are inserted in (1) there results a quadratic equation from which x may be derived

$$x^2 + 2 x n \frac{F_e + F_e'}{b} = \frac{2n}{b} (h F_e + h' F_e') \dots \dots \dots (7)$$

The same value may be deduced from the condition that the neutral axis passes through the centroid of the effective section, in which the area of steel has

been replaced by an equivalent area of concrete n times larger, and the centroid at the same time lies on the lower edge of the compressed concrete zone.

From the solution of equation (7)

$$x = -\frac{n(F_e + F_e')}{b} + \sqrt{\left(\frac{n(F_e + F_e')}{b}\right)^2 + \frac{2n}{b}(hF_e + h'F_e')} \dots (8)$$

With x determined, σ_b is obtained from equation (4)

$$\sigma_b = \frac{6 M x}{b x^2(3h - x) + 6 F_e' n(x - h')(h - h')} \dots (9)$$

and σ_e and σ_e' are given by equations (5) and (6).

If $F_e' = 0$ in equations (7) and (8) there result the values given on page 80 for single reinforcement.

Exactly as for single reinforcement, condensed formulas for quick designing may be developed, but they possess no practical value.

Example.—A reinforced concrete slab 100 cm. (39.4 in.) wide is to resist a bending moment of 600,000 cm.-kg. (519,680 in.-lbs.) but a thickness of 30 cm. (7.62 in.) cannot be exceeded. Since, according to Table XXXI, a thickness of 33 cm. (8.38 in.) is necessary, a fiber stress σ_b more than 40 kg/cm² (569 lbs/in²) will be developed if none but lower reinforcement is provided, and such as will make $\sigma_e = 1000$ kg/cm² (14,223 lbs/in²). In fact, with $F_e = 28.5$ cm² (4.42 in²) $\sigma_b = 46.5$ and $\sigma_e = 1010$ kg/cm² (661 and 14,365 lbs/in², respectively). In order

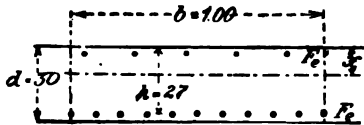

FIG. 81.

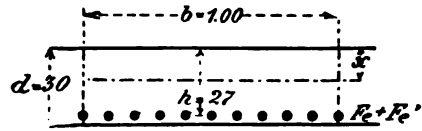

FIG. 82.

to reduce σ_b , upper reinforcement is introduced amounting to $F_e' = 9.5$ cm² (1.47 in²), and there is then obtained with $h = 27$ cm. and $h' = 3$ cm. (10.63 and 1.18 ins. respectively). (See Fig. 81.)

$$x = -15 \frac{(28.5 + 9.5)}{100} + \sqrt{15^2 \frac{(28.5 + 9.5)^2}{100^2} + \frac{2 \times 15}{100} (27 \times 28.5 + 3 \times 9.5)}$$

$$= 10.8 \text{ cm. (4.75 ins.);}$$

$$\sigma_b = \frac{6 \times 600,000 \times 10.8}{100 \times 10.8^2 (3 \times 27 - 10.8) + 6 \times 9.5 \times 15 (10.8 - 3) (27 - 3)}$$

$$= 39.7 \text{ kg/cm}^2 \text{ (565 lbs/in}^2\text{);}$$

$$\sigma_e = n \frac{\sigma_b (h - x)}{x} = 15 \times \frac{39.7 \times 16.2}{10.8} = 894 \text{ kg/cm}^2 \text{ (12716 lbs/in}^2\text{);}$$

$$\sigma_e' = n \frac{\sigma_b (x - h')}{x} = 15 \times \frac{39.7 \times 7.8}{10.8} = 431 \text{ kg/cm}^2 \text{ (6130 lbs/in}^2\text{).}$$

If now the upper reinforcement F_e' is combined with the lower so that only a singly reinforced slab is secured, with $F_e = 28.5 + 9.5 = 38 \text{ cm}^2$ (5.89 in^2) (see Fig. 82), there is obtained

$$x = \frac{n F_e}{b} \left[-1 + \sqrt{1 + \frac{2 b h}{n F_e}} \right],$$

$$x = \frac{15 \times 38}{100} \left[-1 + \sqrt{1 + \frac{2 \times 100 \times 27}{15 \times 38}} \right],$$

$$= 12.74 \text{ cm. (5.02 ins.)};$$

so that

$$\sigma_b = \frac{2 M}{b x \left(h - \frac{x}{3} \right)} = \frac{2 \times 600,000}{100 \times 12.75 \times 22.75} = 41.3 \text{ kg/cm}^2 \text{ (587 lbs/in}^2\text{)},$$

$$\sigma_e = \frac{M}{F_e \left(h - \frac{x}{3} \right)} = \frac{600,000}{38 \times 22.75} = 695 \text{ kg/cm}^2 \text{ (9885 lbs/in}^2\text{)}.$$

By comparing the two examples, it is seen that the unit compressive stress σ_b is almost as low when the tension reinforcement is increased by F_e' .* From the standpoint of safety alone, the author prefers the proceeding of the last example in many cases instead of employing a compression reinforcement, because the reduction of the steel stress σ_e means corresponding increase in safety, since experiment shows that the compressive strength of concrete in bending increases with the percentage of tension reinforcement.

* As when designed otherwise.—TRANS.

CHAPTER VII
THEORY OF REINFORCED CONCRETE

ACTUAL ULTIMATE BENDING TESTS OF REINFORCED
CONCRETE SLABS IN THEIR RELATION TO THEORY

TESTS of reinforced concrete slabs have been copiously discussed in the technical magazines * and have been subjected to thorough theoretical analysis by Ostenfeld, v. Emperger and others, somewhat along the lines already indicated.

It has been found that the compressive strength of concrete developed, in tests, increases with extra reinforcement, because a decrease in the ratio n seems to take place during the rupture stage. That is to say, the increase in compressive strength was such as might occur should the steel stress exceed the elastic limit. In other words, calculations with $n=15$, in cases of small percentages of steel where it is fully stressed, do not give correct results, so that a lower value for n must be adopted, which will produce a correspondingly higher value for σ_b .

When an effective depth of $\frac{3}{4}d$ is assumed, it is easy to find the relation between F_c and d which will lead to a minimum cost, but this condition is unattainable with usual costs of materials, because with it the safe compressive strength of the concrete is exceeded.

From a commercial point of view, therefore, the safe compressive strength in bending is of great importance.

In No. II, 1903, p. 94 of *Beton und Eisen*, v. Emperger called attention to the fact that the strength in compression of mass concrete derived from direct pressure tests of plain concrete cubes, should not be used to determine the safe compressive strength of reinforced concrete in bending; but rather, the actual computed compressive stresses derived from ultimate bending tests, deduced in the same manner as those used to determine theoretical dimensions. This method possesses the advantage of almost entirely eliminating the effects of arbitrary inaccurate assumptions which enter most methods of calculation. It can also be employed with any other method of computation.

Wayss and Freytag conducted some experiments in accordance with v. Emperger's ideas. The concrete was mixed in the proportions of 1:4, the same as the tests already described, and when 13 months old the specimens were

* G. A. Wayss, "Das System Monier," 1887; Sanders, "Beton und Eisen," No. IV, 1902. Ostenfeld, Christophe, "Beton und Eisen," No. V, 1902; Johannsen-Moskau, "Beton und Eisen," No. I, 1904.

tested at the Testing Laboratory of the Royal Technical High School in Stuttgart. The sections of three slab-like pieces, which averaged about 10 by 31 cm. (3.9 by 12.2 in.), (Fig. 84), were 2.20 meters (86.8 in.) long and the reinforcement consisted of five round bars 10 mm. ($\frac{3}{8}$ in.) in diameter. The other three had sections of about 10 by 25 cm. (3.9 by 9.8 in.), (Fig. 85), and were reinforced with 10 round bars of 10 mm. ($\frac{3}{8}$ in.) diameter.

As is shown in Fig. 83, a part of the reinforcement was bent diagonally upward near the ends, to prevent a premature failure from shear. In the test, the specimens were supported so as to have a clear span of 2 meters (78.7 ins.) and the

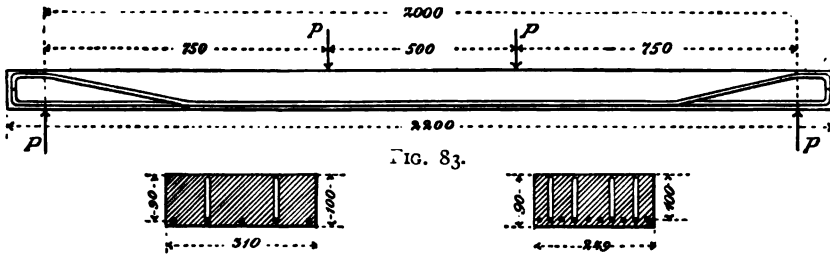

FIG. 84.

FIG. 85.

load was applied at two symmetrically located points 0.50 meter (19.7 ins.) apart, in a continuous operation until rupture was produced. Because of the high percentage of reinforcement employed (from 1.4 to 3.3% of the section), in all specimens, the break occurred at the upper surface, through over-stressing the concrete in compression. This failure occurred in the vicinity of one of the loads and between the two points of their application.

The appearance of the fracture is shown in Fig. 86.

The stresses were calculated according to method 3, page 80, with $n=15$, the weight of the specimen being taken into consideration as well as the measured loads. In the specimen 31 cm. (12.2 in.) wide with 1.4% of reinforcement, at the occurrence of the first crack the average load was $P=570$ kg. (1254 lbs.) for which

$$\sigma_e = 1570 \text{ kg/cm}^2 \text{ (22,330 lbs/in}^2\text{),}$$

$$\sigma_b = 92.5 \text{ kg/cm}^2 \text{ (1315 lbs/in}^2\text{).}$$

In the case of the slab 25.1 cm. (9.9 in.) wide, with 3.3% of reinforcement, the load averaged $P=1080$ kg. (2376 lbs.) and

$$\sigma_e = 1470 \text{ kg/cm}^2 \text{ (20,900 lbs/in}^2\text{),}$$

$$\sigma_b = 158 \text{ kg/cm}^2 \text{ (2247 lbs/in}^2\text{).}$$



FIG. 86.

Stage IIb was really the one involved, since the steel stress was still within the elastic limit.

For the breaking load there was obtained in the same manner with P = from 1444 to 2060 kg. (3178 to 4534 lbs.)

$$\text{with 1.4\% reinforcement: } \sigma_e = 3800 \text{ kg/cm}^2, \quad \sigma_b = 224 \text{ kg/cm}^2, \quad x = 4.2 \text{ cm.} \\ (54047 \text{ lbs/in}^2) \quad (3186 \text{ lbs/in}^2) \quad (1.65 \text{ in.})$$

$$\text{with 3.3\% reinforcement: } \sigma_e = 2750 \text{ kg/cm}^2, \quad \sigma_b = 296 \text{ kg/cm}^2, \quad x = 5.7 \text{ cm.} \\ (39113 \text{ lbs/in}^2) \quad (4210 \text{ lbs/in}^2) \quad (2.2 \text{ in.})$$

From these experiments is shown the amount of increase in compressive strength of reinforced concrete with increase of reinforcement. As already stated, the cause is to be sought in the fact that with low percentages of reinforcement, or with a steel stress above the elastic limit, calculations with $n=15$ do not give correct results.

According to the "Leitsätze," one-fifth of the observed ultimate strength may be taken as a safe working stress. On the basis of the foregoing tests, there results

$$\text{with 1.4\% reinforcement, } \sigma_b = \frac{224}{5} = 45 \text{ kg/cm}^2 \text{ (640 lbs/in}^2\text{),}$$

$$\sigma_e = \frac{3800}{5} = 760 \text{ kg/cm}^2 \text{ (10,809 lbs/in}^2\text{);}$$

$$\text{with 3.3\% reinforcement, } \sigma_b = \frac{296}{5} = 59 \text{ kg/cm}^2 \text{ (853 lbs/in}^2\text{),}$$

$$\sigma_e = \frac{2750}{5} = 550 \text{ kg/cm}^2 \text{ (7822 lbs/in}^2\text{).}$$

In the last case, however, it is impossible to fully stress the steel, and the stress decreases, the higher the percentage becomes.

It can safely be maintained that the correct values have been selected in the "Leitsätze" with $\sigma_e = 1000 \text{ kg/cm}^2$ (14,220 lbs/in²) and 0.75% of reinforcement together with $\sigma_b = 40 \text{ kg/cm}^2$ (569 lbs/in²).

It may be advisable in certain cases, in the compressed lower edges of beams of variable depth, for example, to allow higher stresses. In such cases, however, the steel stresses must be kept down (by using greater percentages of reinforcement).

In addition to this series of tests, another very similar series was conducted, in which the age of the specimens was only two months. At the same time six cubes of the same age, made with the same wet concrete, were prepared.

With $n=15$, the calculated stresses at the time of the first tension cracks were as follows:

with 1.4% of steel: $\sigma_e=1310$ kg/cm², $\sigma_b=77$ kg/cm²,
(18,632 lbs/in²) (1095 lbs/in²)

with 3.3% of steel: $\sigma_e=1195$ kg/cm², $\sigma_b=128$ kg/cm²,
(16,996 lbs/in²), (1821 lbs/in²)

At rupture,

with 1.4% of steel: $\sigma_e=3150$ kg/cm², $\sigma_b=185$ kg/cm²,
(44800 lbs/in²), (2631 lbs/in²),

with 3.3% of steel: $\sigma_e=1970$ kg/cm², $\sigma_b=211$ kg/cm²,
(28000 lbs/in²), (3000 lbs/in²).

Owing to the retention by the cast-iron moulds of too much moisture, the compressive strength of the cubes was only 139 kg/cm² (1977 lbs/in²).

BENDING TESTS OF CONCRETE BEAMS WITH DOUBLE REINFORCEMENT.

Tests of concrete beams containing reinforcement against both tension and compression are comparatively rare. The existing material is described and analyzed in Nos. III and IV, 1903, of *Beton und Eisen* by v. Emperger. The conclusion is reached that an increase in the compressive strength can be secured by the introduction of steel into the compression zone only when such reinforcement is well anchored by a proper number of stirrups, so as to prevent buckling of the compression rods, which might otherwise cause premature failure.

Usually there can be applied to the calculations of doubly reinforced slabs subject to bending, the same formulas as for single reinforcement, since in most cases the tensile strength of the reinforcement will determine the carrying capacity.

It is recommended with regard to compression reinforcement of slabs and beams, that the same precautions be employed as in the case of heavily reinforced columns. This should be done at least until by further tests the accuracy of the ordinary methods of calculation has been demonstrated. As was shown in the examples, it is much better to increase the tension reinforcement than to add steel to resist compression.

Where it becomes necessary to strengthen the compression zone of reinforced concrete beams because of restricted depth of member, it can be effected with the greatest certainty by the introduction of spirals placed side by side throughout the critical portions. This point will be further discussed in connection with the subject of continuous beams.

Method of Calculation According to Ritter

In the 1899 volume of the Schweizerische Bauzeitung, W. Ritter published several methods of calculation, based on various assumptions, of which the one described in the following paragraphs has found universal recognition in Switzerland.

For the determination of the position of the neutral axis, the concrete is regarded as possessing tensile strength and the section of the reinforcement is replaced by an n -fold greater concrete area. Ritter then supposes the neutral axis to pass through the centroid of the imaginary areas. He computes the moment of inertia of the section and then calculates the compressive stress in the concrete according to the usual formulas.

With regard to the necessary section of steel, the assumption is made that the concrete may crack in tension, but that even then the location of the neutral axis is unchanged and it therefore follows that

$$F_e = \frac{M}{\left(h - \frac{x}{3}\right) \sigma_c}$$

With the method of calculation recommended on page 87, the unit stress on the concrete is somewhat lower, especially with deficient reinforcement, and the steel stress correspondingly slightly higher than in the Ritter method, because the arm of the couple between the tensile and compressive forces is slightly smaller.* For ordinary percentages of reinforcement, the Ritter method can be replaced for all practical purposes by the old Könen method, because the neutral axis lies very little below the center of the slab. In case a safe compressive stress for the concrete is assumed, practical and serviceable results are obtainable.

As an example, the ultimate stresses in the previously described slabs have been calculated according to Ritter, in order to determine permissible working stresses to be used with his method. For the specimens with 1.4% of reinforcement (Fig. 87) and $n=20$ (according to the Swiss "Normen") the distance of the neutral axis below the center of the slab is

$$x - \frac{d}{2} = \frac{20 \times 3.93 \times 4}{31 \times 10 + 20 \times 3.93} = 0.8 \text{ cm. (0.31 in.)};$$

$$J = \frac{1}{3}(5.8^3 + 4.2^3) + 20 \times 3.93 \times 3.2^2 = 3585.6 \text{ cm}^4 \text{ (86.1 in}^4\text{)}.$$

The breaking moment is

$$M = 111,825 \text{ cm.-kg. (96,856 in.-lbs.),}$$

so that the compressive strength of the concrete amounts to

$$\sigma_b = \frac{111,825 \times 5.8}{3585.6} = 180 \text{ kg/cm}^2 \text{ (2559 lbs/in}^2\text{)}.$$

* And the position of the neutral axis somewhat altered.—TRANS.

It is 224 kg/cm² (3186 lbs/in²) according to page 92.

Therefore, if according to the German "Leitsätze" $\sigma_b = 40 \text{ kg/cm}^2$ (569 lbs/in²) is accepted, then the safe working stress according to the Ritter method on the basis of this test will be

$$\frac{40 \times 180}{224} = 32 \text{ kg/cm}^2 \text{ (455 lbs/in}^2\text{)}.$$

According to the Swiss "Normen," $\sigma_b = 35 \text{ kg/cm}^2$ (498 lbs/in²) is allowed. With lower percentages of reinforcement, the difference between the two methods

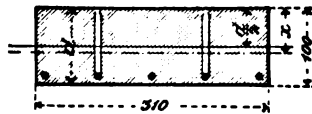

FIG. 87.

is somewhat greater. For instance, with 0.75% of reinforcement, a stress of 40 kg/cm² (569 lbs/in²) calculated according to the German "Leitsätze," would correspond with one of only 28.5 kg/cm² (405 lbs/in²) according to the Swiss "Normen." It would seem, therefore, that their allowable working stress of 35 kg/cm² (498 lbs/in²) for concrete in bending is somewhat too high.

According to the method and tables of pages 83 to 86, the neutral axis falls slightly above the center of the slab, whereas with the method of calculation followed in Switzerland, it falls below the center of the slab.

Position of Neutral Axis

An excellent explanation concerning the position of the neutral axis was secured through some tests as to the elasticity of reinforced concrete conducted at the Testing Laboratory at Stuttgart.

The specimen shown in Fig. 88 was tested in bending, by means of two symmetrical loads. Thus, a constant moment was secured throughout the space

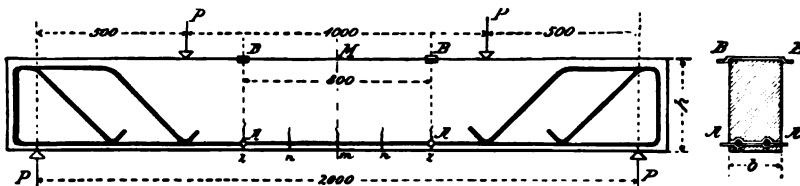

FIG. 88.

between the loads where was located the measured length. At each stage of the loading, the shortening of the upper concrete surface was measured, together with the lengthening of the lower layer of steel. Because of the constancy of the moment and the absence of cross stresses within the measured length, the assump-

tion of the conservation of plane sections during deformation was justified at least as long as no cracks appeared in the tension concrete.

Experiments of other testing laboratories with measurements taken at different heights have not shown this conservation of plane section. The fact remains, however, that, could measurements be made closely adjacent to a concentrated load, it would doubtless be found that changes of length at different heights were not proportional to the distance from the neutral axis. That is, because of changes in shearing stress, neighboring sections formerly plane, become curved.* Measurements during stage II*b*, when isolated cracks were visible, showed no apparent irregularity compared with those of the previous stage. This was probably due

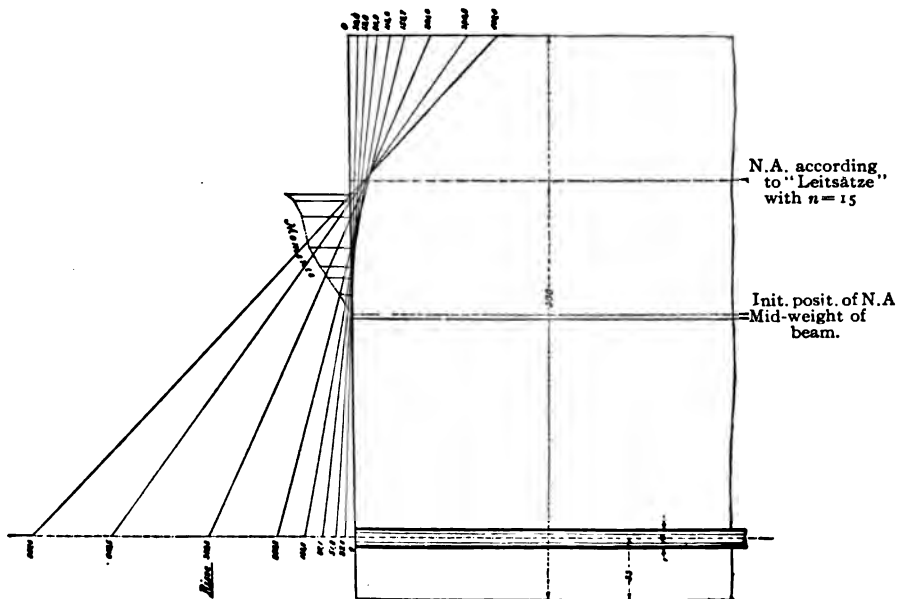

FIG. 89.

to the great measured length, 80 cm. (31.5 in.), so that the effect of the separate cracks was distributed throughout the whole length.

In Figs. 89 to 91, the measured compression of the concrete layer most distant from the neutral axis, and the stretch of the steel are plotted to a convenient scale—the figures employed indicating millionths of the length. The points of corresponding strain are connected by straight lines † corresponding with the idea of the conservation of plane sections, so that the location of the neutral axis for any corresponding strains is given by the point of intersection of the connecting line with the vertical representing the cross-section.

* Compare v. Bach "Biegeversuche mit Eisenbetonbalken," Berlin, 1907, pages 7 and 8.

† The effect of the weight of the specimen on the bending moment has been taken into account. Although but small in itself, it was only after this was done that it was possible to secure a proper agreement with regard to the stress distribution in the section.

The figures are the average of three tests. It will be seen that the neutral axis is lower, the greater is the amount of reinforcement; but that in all three

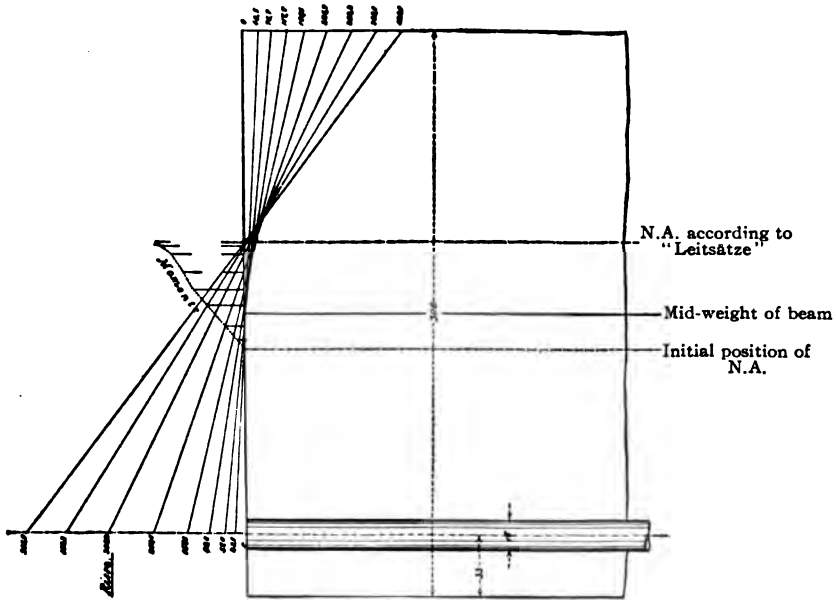

FIG. 90.

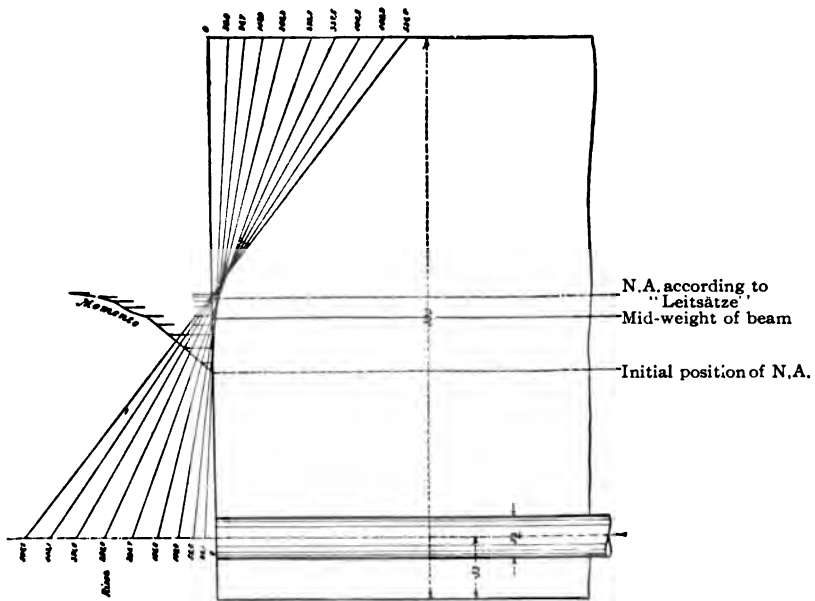

FIG. 91.

varieties of specimens it moved upward with increasing load. Its initial position, with zero strain, may be determined, if in each position of the neutral axis

the corresponding moment is plotted upon a perpendicular to the cross-section, and this moment curve is prolonged to an intersection with the section line. The curve thus obtained therefore furnishes a picture of the relation between the bending moment and the displacement of the neutral axis. It is shown in Figs. 89 to 91, as a dotted line. It will be seen that a Stage I, with a constant modulus of elasticity of the concrete for tensile and compressive stresses does not exist, but that with the least loading an elevation of the neutral axis results.

With the light reinforcement of 0.4% (2 rods 10 mm. ($\frac{3}{8}$ in.)) in diameter, the initial position coincides almost exactly with the center of the slab, whereas with the heavier reinforcement of 1% (2 rods 16 mm. ($\frac{5}{8}$ in.)) in diameter, it falls considerably below the center. In all three cases it coincides very closely with the calculated position given by the Swiss Requirements, with $n=20$. On the other hand, the highest (measured) position of the neutral axis corresponds closely with that calculated by the German "Leitsätze" with $n=15$.

From the dotted line showing the moments it can be determined with certainty that with increasing moments, the neutral axis would approach asymptotically a finite position that would differ but slightly from that obtained by calculation, at least as long as Stage IIb, or the elastic limit of the steel it not exceeded. It can therefore be concluded that the observed positions of the neutral axis in sections with stress conditions intermediate between Stages IIa and IIb, coincide with the positions calculated according to the "Leitsätze."

The exact location of the neutral axis in the cross-section where cracks have developed will probably never be certainly demonstrated experimentally. With large measured lengths only an average position is obtained.

Later, the calculation of the position of the neutral axis for Stage IIa will be considered on the basis of the observed stress distribution in the cross-section.

The tests under discussion afford a very instructive insight into this stress distribution during Stage II.

Since, with the arrangement adopted for the experiments, sections must always remain plane within the measured length, from Figs. 89 to 91, the deformation of the concrete at any point can be determined, and, with the help of the stress-strain curve made previously for concrete of the same age and composition, the corresponding stresses may be obtained. Hence, for each section there can be plotted a curve showing horizontally the stress corresponding to each observed deformation across the section considered as axis of ordinates (Figs. 92 to 94) and thus obtain for the pressure zone a stress surface, the area of which is equal to the resultant compressive force D , which must pass through its centroid.

Since the bending moment M is known, the equation $y = \frac{M}{D}$ gives the arm of the couple formed by D and the tensile force Z which, with simple bending, must be equal to the compressive force D .

The tensile force Z is composed of two components, viz., the strength Z_e of the steel which can be calculated from the measured stretch E_s of the steel and its previously determined modulus of elasticity ($2,160,000 \text{ kg/cm}^2 = 30,600,000 \text{ lbs/in}^2$) and a tensile force Z_b representing the resultant of all tensile stresses in the concrete below the neutral plane. From the known points of application of

Z and Z_e , that of Z_b can be located. The value of Z_b must be equal to the area of the tension-stress surface of the concrete, and it should traverse the centroid of that area.

In Figs. 92 to 94 the tension-stress curves have been drawn as full lines only as far as the observed stretch of the concrete corresponds with elasticity tests. The further presumptive course of the line is shown dotted.

When such a course is chosen for this line that:

1. The surface it bounds is equal to Z_b ,
2. Its centroid coincides with the computed position of Z_b , and
3. The previously observed tensile strength of non-reinforced concrete is not materially exceeded;

then it may be concluded that the assumed course of the line of stress coincides with its actual course. As may be gathered from Figs. 92 to 94, this coincidence is very satisfactory in view of the variable composition of the concrete. It also applies to higher loads where isolated cracks have been noted.

Table XXXII gives information concerning the quantities M , D , Z , Z_e , and Z_b . From the last two columns of figures it may be seen to what extent the calculated Z_b corresponds with the assumed value from the tension-stress surface of the concrete.

With regard to the high position of Z_b in the specimens with heavy reinforcement, it may be noted that the cross-section of the reinforcement is to be deducted from the concrete surface. All quantities are based on a width of 1 cm.

TABLE XXXII

| Reinforcement. | Moment, kg.-cm. | D from the Stress Strain Curves, kg. | $Z_e = F_e \times E_c \times e_e$ kg. | $y = \frac{M}{D}$ cm. | $Z_b = Z - Z_e$ kg. | Z_b from the Stress Strain Curves, kg. | First Crack |
|--------------------------------|-----------------|--|--|--------------------------|------------------------|--|-------------|
| 2 rods, 10 mm. diameter = 0.4% | 1932 | 96 | 0.105 × 2.16 × | 51.8 = 12 | 20.7 | 84 | |
| | 2826 | 134 | | 87.1 = 20 | 21.0 | 113 | |
| | 3659 | 180 | | 133.6 = 30 | 20.2 | 150 | |
| | 4492 | 218 | | 206.8 = 47 | 20.6 | 171 | |
| | 5326 | 254 | | 389.8 = 88 | 20.9 | 166 | * |
| | 6159 | 323 | | 649.5 = 147 | 19.2 | 176 | 180 |
| | 6992 | 388 | | 857.8 = 195 | 18.1 | 193 | 200 |
| | 2833 | 148 | | 57.0 = 33 | 19.1 | 115 | 98 |
| | 4083 | 213 | | 99.8 = 58 | 19.2 | 155 | 140 |
| | 5333 | 269 | | 157.8 = 91 | 19.8 | 178 | 165 |
| 2 rods, 16 mm. diameter = 1.0% | 6583 | 339 | 0.268 × 2.16 × | 247.4 = 143 | 19.4 | 196 | 190 |
| | 7833 | 388 | | 365.2 = 212 | 20.1 | 176 | 171 |
| | 9083 | 442 | | 479.5 = 278 | 20.5 | 164 | 180 |
| | 10333 | 512 | | 585.0 = 338 | 20.3 | 174 | 181 |
| | 3673 | 200 | | 58.7 = 65 | 18.4 | 135 | 100 |
| | 5340 | 273 | | 100.0 = 110 | 19.5 | 163 | 137 |
| | 7007 | 343 | | 156.0 = 171 | 20.4 | 172 | 163 |
| | 8673 | 456 | | 224.7 = 245 | 19.0 | 211 | 191 |
| | 10340 | 527 | | 298.0 = 327 | 19.6 | 200 | 196 |
| | 12007 | 603 | | 371.0 = 407 | 19.9 | 196 | 201 |
| 13673 | 685 | 442.1 = 485 | 20.0 | 200 | 199 | | |
| 2 rods, 22 mm. diameter = 1.9% | | | 0.507 × 2.16 × | | | | * |

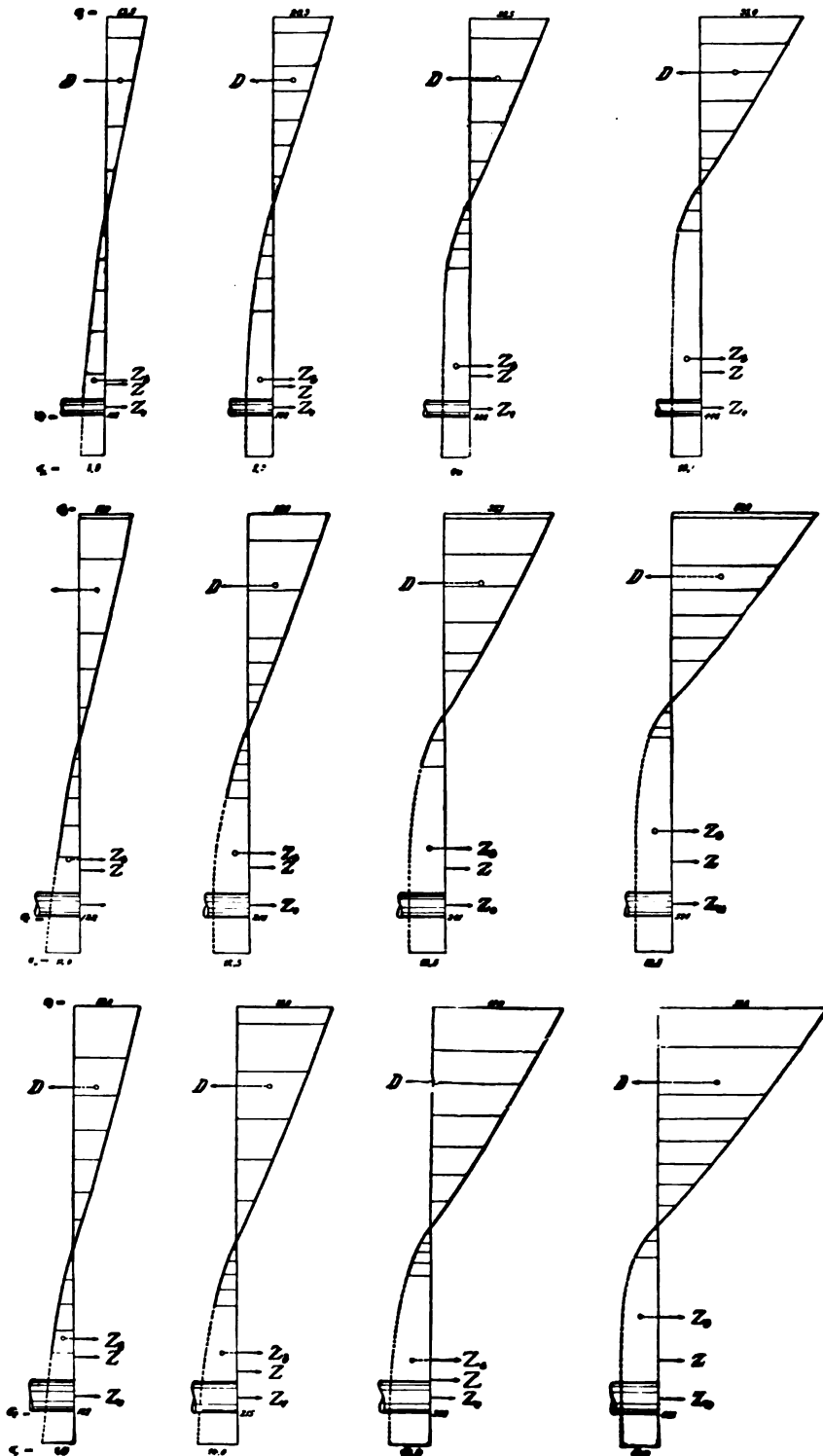

Distribution of stress in rectangular sections

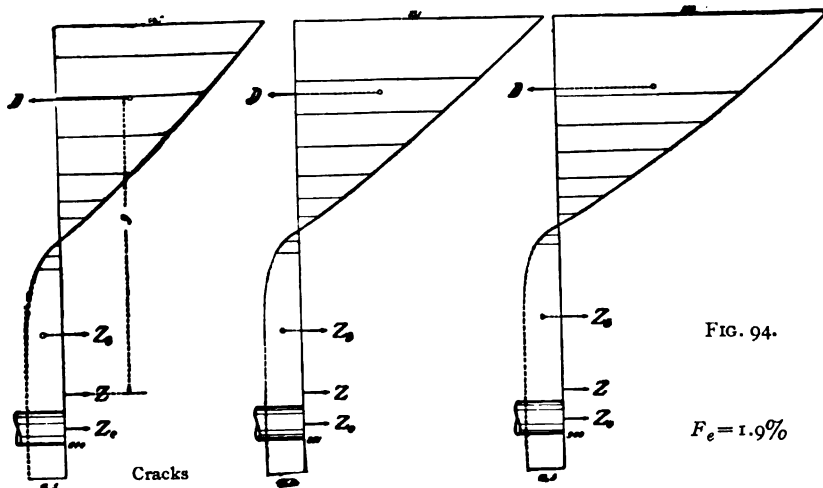
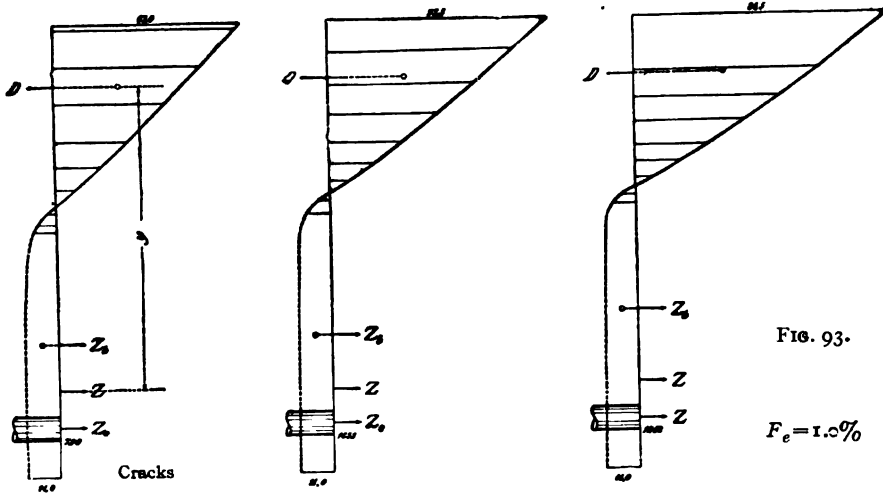
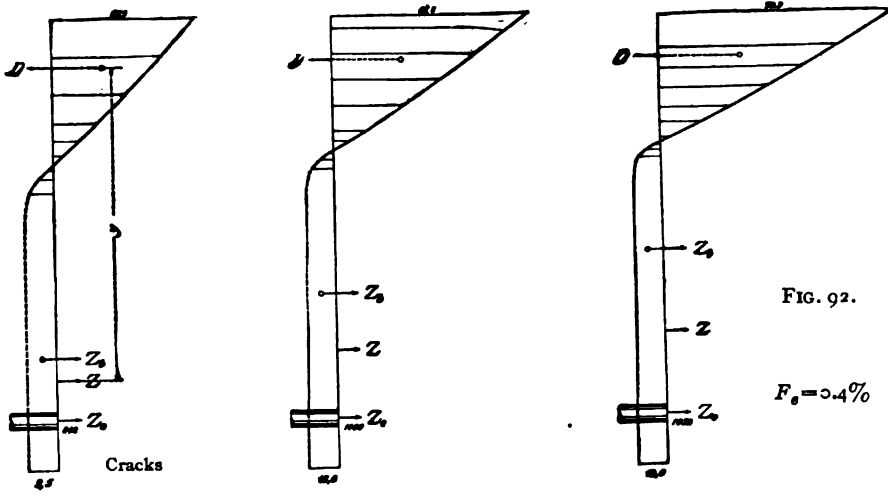

15 by 30 cm., with varying percentages of reinforcement.

The less satisfactory coincidence in the case of the first loadings with heavy reinforcement may be explained as due to initial stresses in the concrete, because of shrinkage. The measured tensile strength of 1:4 concrete in the case of the specimens used to measure its elasticity, Fig. 21, was from 8.8 to 10.1 kg/cm² (125 to 143 lbs/in²). A somewhat greater tensile strength in bending in connection with reinforcement is not surprising, for in that case every eccentric strain is excluded, and a single weak section can have but a slight influence on the results of the measurements. A slight error in D , with the uncertain elastic properties of the concrete, is easily possible, and might produce a wide variation in the position and size of Z_b .

In Figs. 95 to 97, the results of the tests are shown graphically in the following manner:

The moments (which were constant throughout the whole measured length) are plotted as abscissas. The maximum compressive stresses σ_b , computed from the observed shortening of the edge of the concrete and the known stress-strain curves, are shown as ordinates upward. Downward ordinates represent the steel stress σ_s , calculated from the measured stretch and the modulus of elasticity $E_s = 2.16 \times 10^6$ (30,600,000 English equivalent). In this way the curves shown by heavy lines were obtained. The points at which cracks were observed do not correspond above and below, because both curves are the average of three tests each, and because the contractions and extensions could not be measured simultaneously on any specimen. The figures also show by light lines the computed stresses in the steel and concrete for corresponding moments, calculated by method 3, page 80, with $n = 15$ (corresponding with the "Leitsätze"). In the same manner the broken lines show the results of the Ritter method or according to the Swiss "Normen," with $n = 20$. The diagrams thus obtained are very instructive and exemplify in a striking manner the following deductions:

1. First is to be noted from the sharp drop in the tension line for light reinforcement, the well-known fact that with slab reinforcement below 0.75% (that adopted in the "Leitsätze") the safe working steel stress is determinative, while with larger percentages of reinforcement the stress in the concrete is the limiting factor in design.

2. The theoretical compressive stress in the concrete, computed according to the "Leitsätze," is larger than the observed stress under safe load. With heavy reinforcement, the calculated value corresponds almost exactly with that found by measurement. Computations according to the Swiss "Normen" give stresses smaller than those actually observed. In Stage IIb, after the occurrence of cracks, the σ_b obtained according to the "Leitsätze" corresponds satisfactorily with the observed value (obtained from the longitudinal measurements).

3. The theoretical steel stresses obtained by calculation are much greater than are actually observed. This holds good, of course, only until the appearance of cracks. From that point, the steel stress in the cracked cross-sections will be much higher than in the other parts and will attain the values established by calculation.

4. The curve of tensile stress takes the same course as is shown in the Considère experiment, Fig. 50, page 51. Table XXXII, on page 99, shows in figures the same thing in regard to the distribution of tensile stress Z between the forces

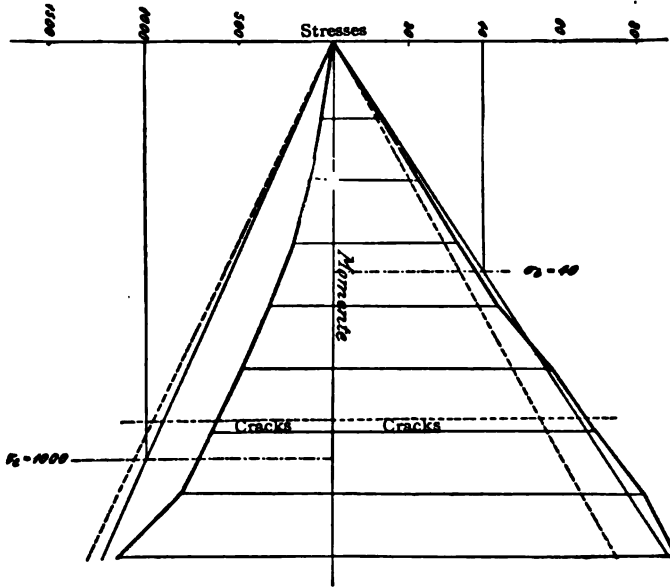

FIG. 97.

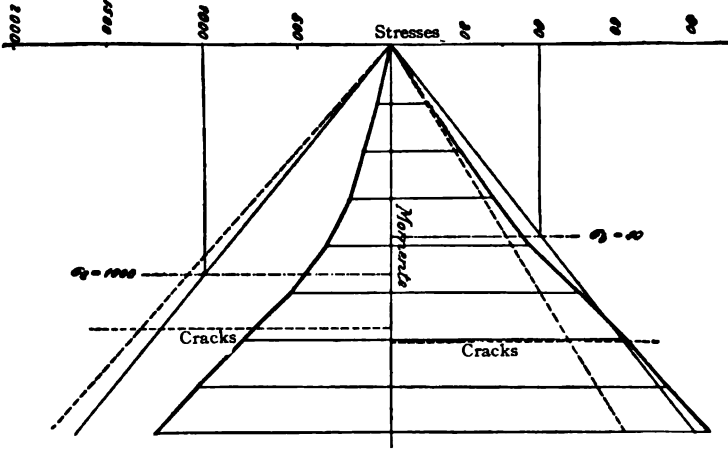

FIG. 96.

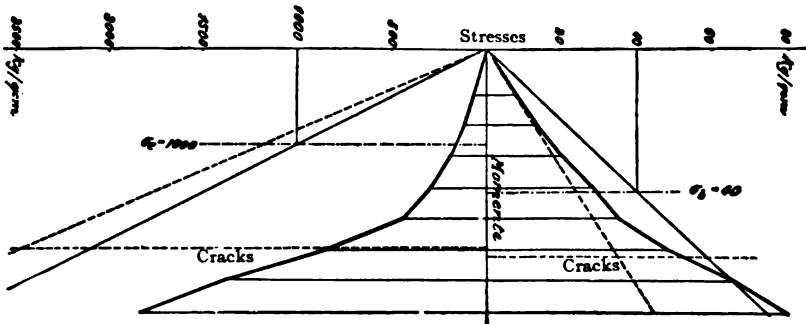

FIG. 95.

— Stresses found by experiment.
 — " computed according to "Leitsätze."
 — " " " " "the Swiss "Normen."
 Diagrams of Moments and corresponding stresses in concrete and steel.

Z_e and Z_b . While Z and Z_e increase with increase of moment, Z_b , except for slight variation, remains practically constant after once attaining its maximum value. As claimed by Considère, therefore, a proportional distribution of tensile stress between steel and concrete must be admitted, but with this difference from Considère's claim, that in the tests here described, thanks to the great care exercised, the tension cracks in the concrete were discovered much earlier. In spite of their existence, however, the distribution of stress remains the same, and the tensile stress Z_b suffers no material decrease. How can this phenomenon be explained, if the ductility of concrete assumed by Considère fails us?

According to the records of the tests, cracks first appeared at the pins A ; next, within the measured length (the cracks n); and finally the crack m . As the lateral forces within the measured length are nil, there occur during Stages I and IIa within this part no sliding stresses. As soon, however, as Stage IIb is entered, and a crack occurs in a cross-section, the reinforcement is subjected at that point to more severe stresses, and in the adjoining sections the adhesion or rather resistance to sliding must assume its full importance in the adjustment of stresses between the concrete and steel. If a frictional resistance of 33 kg/cm^2 (469 lbs/in^2) is assumed, there is obtained for the specimen with 2 rods 16 mm. ($\frac{5}{8}$ in.) in diameter a length of

$$\frac{15Z_b}{2 \times 3.14 \times 1.6 \times 33} = \frac{15 \times 180}{207} = 8.1 \text{ cm. (3.2 in.)},$$

which is necessary to restore in the concrete the stress to which it was originally subjected. Because of friction against the reinforcement, and of the tensile strength which still exists in the pieces lying between cracks, even cracked concrete decreases to some extent the stretch of the reinforcement.* Through these causes is obtained an almost constant value of Z_b , even after the occurrence of cracks, as would be obtained in conjunction with the phenomenon of ductility of concrete, which, however, in reality does not exist.

It cannot be asserted positively that Considère, in his tests, overlooked the cracks, but on the other hand it should be observed that from the specimens of the tests here described, pieces of concrete 20 to 40 cm. (8 to 16 ins.) in length between cracks could have been removed entirely, and they would have displayed their full tensile strength. The cracks were at first visible only beneath the reinforcement, so that it does not appear impossible that the higher concrete layers might yet resist tensile stress.

* By employment of stretch measurements with small units of measure, even the relative displacement of the concrete with regard to the steel can be noted. See Christophe, *Beton und Eisen*, No. V, 1902, p. 14. On the other hand, the use of too small units is the cause of many diverse results in otherwise scientific experiments.

Safety of the Concrete against Tension Cracks

5. Especially with light reinforcement, the tensile stress taken up by the concrete relieves the steel to such an extent that its stretch remains considerably below the calculated figures. With more liberal reinforcement, this is not the case, but here the limit of compressive stress in the concrete, warrants no further increase in the size of the reinforcement. Consequently, when designing according to the "Leitsätze," i.e., according to the conditions in Stage IIb, in all cases is obtained a factor of safety against cracking in rectangular slabs which amounts to

2.12 with 0.4% of reinforcement;

1.50 with 1.0% of reinforcement;

1.64 with 1.9% of reinforcement.

Similar results are afforded by the experiments described on pages 92 and 93, in which the computed unit stresses at the appearance of the first crack, as compared with $\sigma_c = 1000$ and $\sigma_b = 40$ kg/cm² (14,220 and 569 lbs/in²), give the following factors of safety against cracking of the concrete:

2.3 with 13 months old specimens with 1.4% of reinforcement;

3.9 with 13 months old specimens with 3.3% of reinforcement;

1.9 with 2 months old specimens with 1.4% of reinforcement;

3.2 with 2 months old specimens with 3.3% of reinforcement.

In this connection is to be noted other valuable material by Bach in the *Zeitschrift des Vereins Deutscher Ingenieure*, 1907. With regard to rectangular sections with such reinforcement as is usually employed in practice, it is shown that, with the approved method of calculation which ignores tension in concrete, a factor of safety is obtained of 1.2 to 1.4 against the first, extremely fine, almost imperceptible tension cracks. The heavily reinforced beams, however, (*i* and *k* of the quoted list) showed the first tension crack at a computed steel stress of 765 kg/cm² (10,881 lbs/in²) for the 1.4% of reinforcement, with a corresponding concrete compressive stress of 45.2 kg/cm² (643 lbs/in²). In this case the computed stress was 1.1 times the assumed safe one. In these cases the cracks were so fine that they could not be observed with the usual whitened concrete surface. A certain amount of practice was necessary to see them, thereby showing clearly that in the earliest experiments of this kind on similar specimens, much higher stresses actually existed when the cracks were first discovered.

It is thus found from these experiments that the customary methods of calculation according to the "Leitsätze" or the Prussian "Regulations," provide an average factor of safety against the appearance of the first tension crack of 1.2 to 1.5. Of course this applies primarily to rectangular sections. The application to T-beams will be considered later.

The new Prussian "Regulations" of May 24, 1907, in Sec. 15, Par. 3, et seq., require that all buildings which are exposed to the weather, humidity, smoke, gases, and similar harmful influences, besides being designed according to Stage IIb, shall also have the added condition imposed that no cracks shall appear in the concrete because of tensile stresses. The allowable tensile stress on concrete must also be restricted to $\frac{2}{3}$ of that obtained by tension experiments, or to $\frac{1}{10}$ of the bending strength, if the tensile strength is exceeded by it. The prescribed method of calculation is identical with that of Ritter, already explained—that is, the moduli of elasticity in tension and compression are considered equal and constant, and the steel may be replaced by a concrete area n times larger. After computation of the location of the neutral axis, as the centroidal axis of this modified section, the stresses can be determined by the well-known equation

$$\sigma = \frac{vM}{J}.$$

The value 15 is selected for n .

There follow some examples of the Stuttgart experiments tested by this new and complicated method of design.*

The distance x of the centroid of the section shown in Fig. 98 from the middle is

$$x = \frac{15 \times 2.36 \times 13.5}{20 \times 30 + 15 \times 2.36} = 0.75 \text{ cm. (0.295 in.)},$$

$$J = \frac{1}{3} \times 20(15.75^3 + 14.25^3) + 15 \times 2.36 \times 12.75^2 = 51,092 \text{ cm}^4 (1226 \text{ in}^4),$$

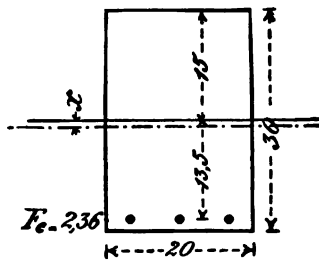

FIG. 98.

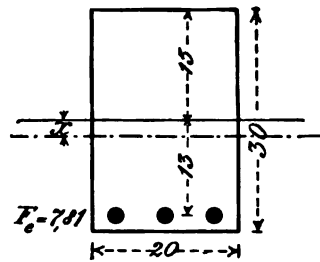

FIG. 99.

so that the tensile stress on the concrete at the appearance of the first crack at a moment of $M = 98,348 \text{ kg-cm (85,183 in-lbs)}$ was

$$\sigma_s = \frac{14.25 \times 98,348}{51,092} = 27.4 \text{ kg/cm}^2 (390 \text{ lbs/in}^2).$$

As a matter of fact the tensile strength of concrete is only about 13 kg/cm^2 (185 lbs/in^2). The foregoing example is of a beam with only 0.43% of reinforcement, while the following is for one with 1.4% (Fig. 99). In it

$$x = \frac{15 \times 7.81 \times 13}{20 \times 30 + 15 \times 7.81} = 2.1 \text{ cm. (0.827 in.)};$$

$$J = \frac{1}{3} \times 20(17.1^3 + 12.9^3) + 15 \times 7.81 \times 10.9^2 = 61,558 \text{ cm}^4 (1477 \text{ in}^4).$$

* See also "Postuvanschitz," *Beton und Eisen*, No. VI, 1907.

The bending moment at the appearance of the first crack was $M=141,010$ kg-cm (122,134 in-lbs), so that the computed tensile stress on the concrete was approximately

$$\sigma_x = \frac{12.9 \times 141,010}{61,558} = 29.5 \text{ kg/cm}^2 \text{ (420 lbs/in}^2\text{)}.$$

According to the "Regulations," a safety factor of $1\frac{1}{2}$ against tensile cracks is intended, but sight has been lost of the fact that in plain concrete beams of rectangular section, because of the variable value of E , the tensile strength in bending is practically twice that found in direct tension tests. It seems natural, and is proved by these experiments, that the introduction of steel on the tension side makes very little change in this condition. It is thus evident that the Prussian Ministerial "Regulations" of 1907 actually provide a three-fold factor of safety against the appearance of the first crack, and in consequence the execution of reinforced concrete work is needlessly costly and difficult.

Of somewhat more practical value is Labes' "Vorläufigen Bestimmungen für das Entwerfen und die Ausführung von Ingenieurbauten im Bezirke der Eisenbahndirektion Berlin" (No. 52 of the Zentralblätter der Bauverwaltung, 1906).

In it the bending strength $\sigma = \frac{6M}{bh^2}$ is taken as the tensile strength of the concrete and a factor of safety of 2.5 to 1.3 required. The last value applies to sidewalks and light foot-bridges, mangers, water-tanks, and structures subject to slight vibration. For n , a value of 10 is taken, since it produces lower stresses in Stages I and IIa (strictly, the steel section should be multiplied by $n-1$, because of the space displaced by it in the concrete).

The value $n=15$, which is given in the "Leitsätze" for computations according to Stage IIb, would not here apply, in view of the results of elasticity experiments. It is to be noted, however, that this method of calculation does not consider the existing stress under the maximum allowable load, but rather a condition of necessary safety based on stresses developed by much higher loads. It is clear that the value of n should be adapted to this later condition. For slabs, that is, rectangular sections, the factor of safety against tension cracks provided by the above-mentioned discussion is clearly superfluous. The increased safety is secured through more concrete, which, however, at the same time is favorable to vibration. Furthermore, the distribution of the reinforcement tends to prevent the appearance of the first fine cracks.

T-BEAMS

In T-beams, subject to positive bending moments, the slab is always made of a certain width, so as to act statically with the stem, with which it forms a T-shaped section. If, however, the bending moment is negative, as will be the case with beams anchored at the ends, or with those passing over a central support, and again ignoring the tensile strength of the concrete, the calculation should be made just as if no slab existed. That is, one should proceed in exactly the

same manner as indicated above for a rectangular cross-section, but with the difference that the zone of tension is found with its reinforcement in the upper part, and the compression zone in the lower portion of the cross-section, and covering a width equal only to that of the stem (Fig. 100).

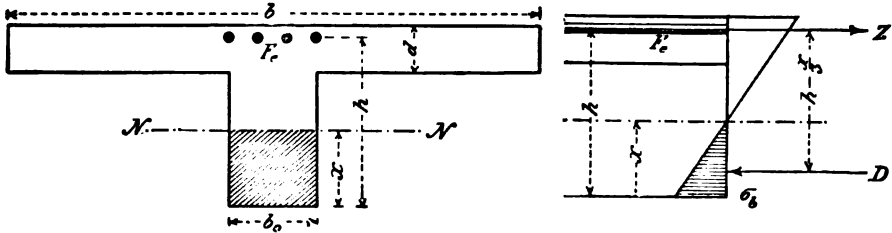

FIG. 100.—Distribution of stress with negative bending moments.

On the supposition that the reinforcement in the stem is uniformly distributed with regard to the effective slab breadth b , calculations for positive bending moments can be made as for a corresponding rectangular section, if the neutral

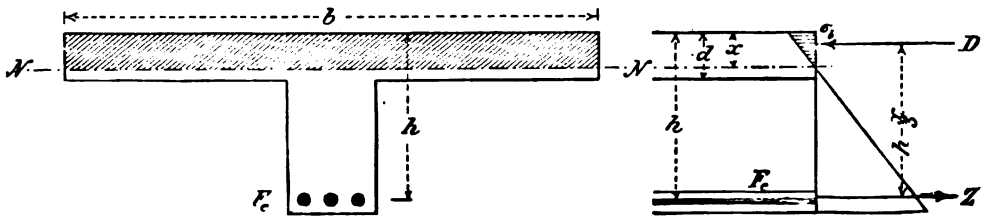

FIG. 101.—Distribution of stress with positive bending moments.

axis falls within the slab or coincides with its lower edge. In the latter case, with the nomenclature of Fig. 101,

$$D = Z$$

$$M = Z \left(h - \frac{d}{3} \right),$$

from which

$$Z = \frac{M}{h - \frac{d}{3}},$$

$$\sigma_s = \frac{Z}{F_s},$$

$$\sigma_b = \frac{2 \cdot Z}{b \cdot d},$$

$$x = \frac{nF_e}{b} \left[-1 + \sqrt{1 + \frac{2bh}{nF_e}} \right].$$

In reality, the neutral axis always falls in the vicinity of the lower edge of the slab. Whenever it falls somewhat below that point, as in Fig. 102, the

shaded portion of the stem there shown (in which insignificant compressive stresses act), can simply be ignored. Consequently, the centroid of compression will be only slightly shifted from one condition to the other.

If it is considered that the lowest possible position of this centroid can be the mid-point of the slab section, the maximum usual value of Z will be given by the formula

$$Z = \frac{M}{h - \frac{d}{2}}$$

It is thus seen that, because of the small possible variation in the location of the centers of tension and compression in T-beams, it is possible to ascertain the tensile stress in the reinforcement with sufficient accuracy for all practical purposes without recourse to special theoretical formulas.

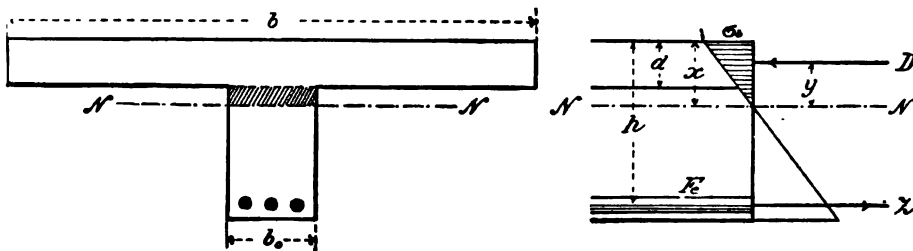

FIG. 102.—Distribution of stress with positive bending moments when $x > d$.

The stress in the concrete at the upper edge of the slab does not vary within such small limits as does the arm of the couple of Z and D . However, for cases in which the neutral axis does not fall within the slab, there may be used the maximum value

$$\sigma_b = \frac{2Z}{bd}$$

or one may proceed according to the following more exact method.

The neutral axis is supposed to lie within the stem, and at a distance x below the upper layer of the slab. h is the distance of the reinforcement from the same layer and its area is represented by F_e . The small compressive stresses in the shaded area of the stem are simply neglected. Then, on the supposition of a constant modulus of elasticity E_b of the compressed concrete, there is found, as for rectangular sections (Fig. 102),

$$\frac{\sigma_b}{E_b} : x = \frac{\sigma_e}{E_e} : (h - x),$$

from which with

$$\frac{E_b}{E_e} = n,$$

there follows

$$\sigma_e = \frac{n\sigma_b(h - x)}{x}$$

and further

$$\sigma_e F_e = \sigma_b \frac{bx}{2} - \frac{\sigma_b(x-d)}{x} b \frac{(x-d)}{2}.$$

Substituting herein the value of σ_e , gives

$$\frac{n\sigma_b(h-x)}{x} F_e = \sigma_b \frac{bx}{2} - \frac{\sigma_b(x-d)^2 b}{2x},$$

from which

$$x = \frac{2nhF_e + bd^2}{2(nF_e + bd)}.$$

The distance of the center of compression or of the centroid of its trapezoid from the neutral plane, computed by the equation of moments, is

$$y = x - \frac{d}{2} + \frac{d^2}{6(2x-d)}.$$

In this equation is clearly to be recognized for $x=d$ the value

$$y = x - \frac{d}{2} + \frac{d}{6} = x - \frac{d}{3} = \frac{2}{3}d,$$

and for greater values of x

$$y = x - \frac{d}{2}.$$

If the center of compression is known, the compressive stress

$$D = Z = \frac{M}{h-x+y},$$

as well as the stress σ_b , and

$$\sigma_b = \frac{\sigma_e x}{n(h-x)} = \frac{\sigma_e (2nhF_e + bd^2)}{nbd(2h-d)}$$

can be computed.

The position of the neutral axis may also be obtained from the condition that it must pass through the centroid of the modified section consisting of the slab and the n -times increased area of the reinforcement. The value of x may be immediately derived from the moment equation of this area about the upper edge of the slab. From x , the computation of y is easily made, and then the well-known equation $\sigma = \frac{vM}{J}$ can be employed. In that case

$$\sigma_b = \frac{xM}{J},$$

$$\sigma_e = n \frac{(h-x)M}{J}.$$

Example 1.—A reinforced concrete beam 28 by 50 cm. (11 by 19.7 ins.) stem section, with a reinforcement of 5 round rods 28 mm. ($1\frac{1}{8}$ ins. approx.) in diameter, and a slab 10 cm. (3.9 ins.) thick, with an effective width of 250 cm. (98.4 ins.) has a positive bending moment of 1,430,000 kg-cm (1,236,000 in-lbs).

$$b = 250 \text{ cm. (98.4 ins.), } d = 10 \text{ cm. (3.9 ins.), } h = 57 \text{ cm. (22.4 ins.),}$$

$$F_e = 30.8 \text{ cm}^2 (4.77 \text{ in}^2), \quad n = 15.$$

The position of the neutral plane is calculated to be

$$x = \frac{2 \times 15 \times 57 \times 30.8 + 250 \times 10^2}{2(15 \times 30.8 + 250 \times 10)} = 13.1 \text{ cm. (5.26 in.)}$$

Then

$$y = 13.1 - \frac{10}{2} + \frac{100}{6(2 \times 13.1 - 10)} = 9.1 \text{ cm. (3.58 in.)};$$

$$D = Z = \frac{1,430,000}{57 - 13.1 + 9.1} = \text{about } 27,000 \text{ kg. (59,000 lbs.)};$$

$$\sigma_e = \frac{27,000}{30.8} = 878 \text{ kg/cm}^2 (12,488 \text{ lbs/in}^2);$$

$$\sigma_b = \frac{878 \times 13.1}{15(57 - 13.1)} = 17.5 \text{ kg/cm}^2 (249 \text{ lbs/in}^2).$$

If the neutral plane had been assumed to coincide with the lower edge of the slab, there would have resulted

$$Z = D = \frac{1,430,000}{57 - 3.3} = 26,600 \text{ kg (58,500 lbs.)};$$

$$\sigma_e = 864 \text{ kg/cm}^2 (12,289 \text{ lbs/in}^2);$$

$$\sigma_b = \frac{2 \times 26,600}{250 \times 10} = 21.3 \text{ kg/cm}^2 (303 \text{ lbs/in}^2).$$

Example 2.—The same beam is to have double the reinforcement and be subjected to double the moment. The slab, however, is to be 10 cm. (3.9 ins.) thick. F_e then equals 61.6 cm² (0.965 in²), and there results

$$x = \frac{2 \times 15 \times 57 \times 61.6 + 250 \times 10^2}{2 \times (15 \times 61.6 + 250 \times 10)} = 19.0 \text{ cm. (7.5 in.)};$$

$$y = 19.0 - 5 + \frac{100}{6(2 \times 19.0 - 10)} = 14.6 \text{ cm. (5.75 in.)};$$

$$Z = D = \frac{2,860,000}{57 - 19.0 + 14.6} = 54,370 \text{ kg. (119,800 lbs.)};$$

$$\sigma_e = \frac{54,370}{61.6} = 883 \text{ kg/cm}^2 (12,559 \text{ lbs/in}^2);$$

$$\sigma_b = \frac{883 \times 19.0}{15(57 - 19.0)} = 29.4 \text{ kg/cm}^2 (418 \text{ lbs/in}^2).$$

Example 3.—The same beam as in Example 1 is supposed to be made of concrete possessing a higher modulus of elasticity, so that $n=10$. Then there follows

$$x = \frac{2 \times 10 \times 57 \times 30.8 + 250 \times 10^2}{2(10 \times 30.8 + 250 \times 10)} = 10.7 \text{ cm. (4.2 in.)};$$

$$y = 10.7 - \frac{10}{2} + \frac{100}{6(2 \times 10.7 - 10)} = 7.2 \text{ cm. (2.83 in.)};$$

$$Z = D = \frac{1,430,000}{57 - 10.7 + 7.2} = 26,700 \text{ kg. (58,700 lbs.)};$$

$$\sigma_e = \frac{26,700}{30.8} = 867 \text{ kg/cm}^2 \text{ (12,331 lbs/in}^2\text{)};$$

$$\sigma_b = \frac{867 \times 10.7}{10(57 - 10.7)} = 19.5 \text{ kg/cm}^2 \text{ (277 lbs/in}^2\text{)}.$$

From the three foregoing arithmetical examples, the following conclusions may be derived: When, in a given beam, a doubling of the reinforcement makes possible its carrying double the bending moment, the steel stress varies only to an insignificant extent, while the stress on the upper surface of the slab (when the thickness remains unchanged) increases, but to a less extent than the exterior forces.

In the examples given, the increase is from 17.5 to 29.4 kg/cm² in place of 17.5 to 35.0.

This retarded increase in edge stress has its origin in the movement of the neutral plane to a greater depth.

A similar effect on its position, and in consequence on the concrete stress, is caused by a decrease in the modulus of elasticity E_b (or an increase in n) in such manner that a T-beam of poor material will show a lower stress than one with a richer mixture and correspondingly higher modulus of elasticity E_b under otherwise similar conditions.

The same phenomena also occur in rectangular sections, such as simple slabs.

The decrease in stress occurs, however, much more slowly with decrease of n , than does the diminution in the corresponding compressive strength, so that there is no inducement to employ other than a good mixture.

Attention is again called to the fact that the simplified formulas for the calculation of T-beams are obtained by the somewhat improper neglect of the insignificant compressive stresses in the stem, and by the acceptance of a constant modulus of elasticity E_b .

As to the width of slab b , the "Leitsätze" and the "Regulations" both stipulate that it shall not be greater than $l/3$, that is, each side no greater than $l/6$. At the same time b should evidently not be greater than the beam spacing. Investigations concerning the effective width of slab have not been made, but in this connection a natural limit in the calculations is set when the shear in the two vertical sections of the slab equals that of the stem. More will be said with regard to this point in the chapter on shearing stresses.

The permissible compressive stress in the concrete may be assumed as large

in T-beams as in those of rectangular sections. This maximum stress can be employed in very few cases, however, since too shallow and excessively reinforced beams would be obtained, which above all are uneconomical, and a cheaper, better construction is produced with deeper beams and with a stress in the top layer less than 40 kg/cm² (570 lbs./in²).* In this connection, some authorities claim it is of considerable practical importance that the permissible concrete stress in the slab be considered that stress which is found by including the effect of a possible tensile stress in the concrete at right angles to the beams due to the continuity of the slab. The allowable stress should not exceed a theoretical value

$$\sigma = \sigma_b + \frac{\sigma_z}{m}, \text{ wherein } m = \frac{1}{4} \text{ of the coefficient of lateral dilation.}$$

It is the opinion of the author, however, that this condition cannot be applied to reinforced concrete as to homogeneous materials, for in concrete all the phenomena of longitudinal and lateral dilation differ from those of isotropic materials, because of differences in elasticity and in the ultimate strengths in tension and compression of the former material. It is very important, however, that the tensile stresses in the slab at right angles to the beams, due to the slab rods, be fully cared for. Obviously, somewhat different is the condition with regard to girders. Then, the compressive stresses of the slab as a floor and those of the flanges of the girder must be added. As was said in the Introduction, in consideration of these conditions, it is best to adopt a narrow width of flange b in computing girders, and furnish the slabs where necessary with haunches on the beams. The simple addition of the two compressive stresses is evidently not rigorously correct, since the slab, when acting as a floor, is compressively stressed only in the upper part, while its stress in the capacity of the head of the T-girder is variable throughout the whole zone of compression. The kind of stress in such a slab thus resembles that of bending with axial thrust. Since the above-mentioned suggestion is made purely on constructive grounds, it may well happen that the exact computation of the combined stresses may sometimes be abandoned, especially if more insight is secured into the elastic deformation of a rectangular slab resting on beams and girders. Because of the presence of the distributing rods, a slab-like effect will always exist, in consequence of which practically nothing but T-girder compression stresses act in the slabs close to and parallel with a girder.

In the experience of the author, tables and formulas for the dimensions of T-beams are of small necessity.

For all cases where the neutral axis falls within the slab, so that $x \leq d$, the tables and formulas for rectangular sections can be used. (See pp. 83 and 85.) The values of x are there given so that it is immediately seen whether x is $\leq d$.

The rib spacing, as a rule, is determined by outside conditions, and the thickness of the slab depends on the required carrying capacity between the ribs. For ordinary purposes of design, it suffices to determine the necessary area of steel F_s with the aid of the formula

$$F_s = \frac{M}{\sigma_s \left(h - \frac{d}{2} \right)}$$

* See Mörsch, Deutsche Bauzeitung, 1907, Zementbeilagen, Nos. 11, 12, 13.

If an exact calculation of the stress is then made, σ_e as a rule is found smaller than the allowable safe stress.

If $x \geq d$, the several quantities can be computed from the following formulas:

$$x = \frac{2nhF_c + bd^2}{2(nF_c + bd)};$$

$$\sigma_b = \frac{\sigma_e x}{n(h-x)};$$

$$\sigma_e = \frac{M}{F_c \left(h - \frac{d}{2} \right)}.$$

Also σ_b may be computed more accurately by the formula

$$\sigma_b = \frac{\sigma_e (2nhF_c + bd^2)}{n \quad bd(2h-d)},$$

which thus saves the computation of the neutral axis and the centroid of compression. These formulas apply only to the case where the neutral axis lies at the lower surface of the slab. From them can easily be computed, for rectangular sections and various ratios of $x:h$, corresponding values of σ_b and σ_e .

Since the steel section can be computed very easily and quite accurately from the formula

$$F_c = \frac{M}{\sigma_e \left(h - \frac{d}{2} \right)},$$

and where there is no question as to the compressive unit stress σ_b in the top layer of the slab (since it will surely be less than the allowable one), the most advantageous information for a designer is a statement of the relation between the depth of beam h and the given moment $\frac{M}{b}$, which will produce the allowable stress σ_b . With this in view, the diagrams of Fig. 103 were computed.

The useful depths h are taken as abscissas, and as ordinates the various moments $\frac{M}{b}$, from which are determined curves, which represent various slab depths for the stresses $\sigma_e = 1000$, $\sigma_b = 40$ kg/cm² (14,223 and 569 lbs/in²). When the points shown by circles for each thickness of slab are considered, a curve is produced. The combination is a single parabola starting from the axis, which corresponds with the useful depth in rectangular sections, and which is represented by the formula

$$h = 0.39 \sqrt{\frac{M}{b}}.$$

These diagrams also include the cases where the axis lies along the under side of the slab. The dotted portions of the line show that there the slab thick-

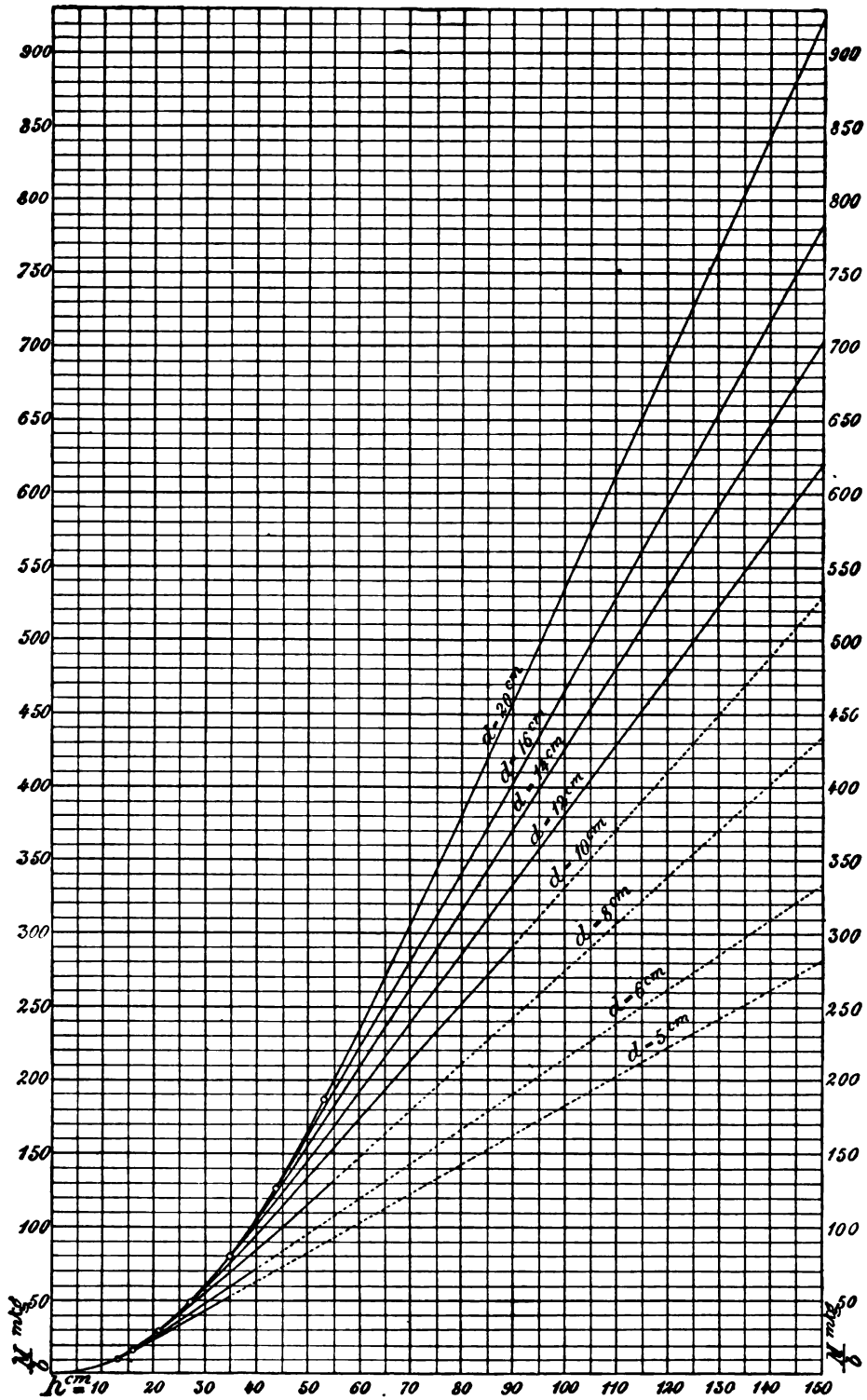

FIG. 103.—Diagram showing the relation between h and $\frac{M}{b}$ in T-beams for various slab thicknesses d , and stresses $\sigma_s = 1000 \text{ kg/cm}^2$, and $\sigma_b = 40 \text{ kg/cm}^2$ (14,220 and 569 lbs/in²).

ness is too thin as compared with the height of beam, so that to be of service the size given must be increased. If a design is selected in which the useful depth h is greater than that shown on the diagram, then the stress σ_b need not be computed, since it is less than 40 kg/cm^2 (569 lbs/in^2) and consequently safe.

The computation of the curves was made from the following formulas:

$$x = \frac{2nhF_e + bd^2}{2(nF_e + bd)}$$

whence follows

$$F_e = \frac{bd(2x-d)}{2(nh-x)} = \frac{M}{\sigma_e(h-x+y)}$$

and with $\sigma_e = 1000$, $\sigma_b = 40$, $x = \frac{3}{8}h$; so that with the substitution of y , there finally results

$$\frac{M}{b} = \frac{d\sigma_e}{3\sigma nh} (18h^2 - 33dh + 16d^2).$$

Exact Formulas for T-Beams

For sake of completeness, formulas which include the compressive stresses in the stem are here included.* In Fig. 104 the location of the neutral axis is com-

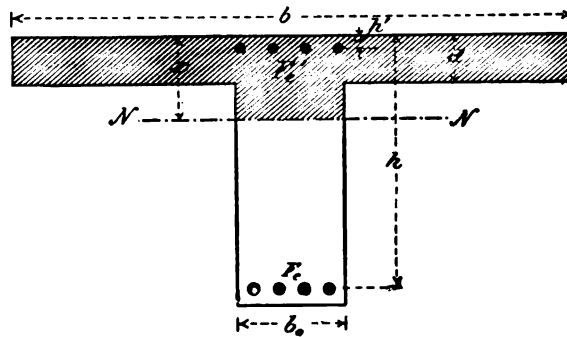

FIG. 104.

puted as the centroidal axis of the section formed by the compressed concrete and the n -fold larger area of the reinforcement, which axis also forms the lower edge of the zone of compression. The equation of the statical moment with respect to the upper edge is

$$x[bd + (x-d)b_0 + n(F_e + F_e')] = \frac{bd^2}{2} + b_0(x-d)\frac{x+d}{2} + n(F_e h + F_e' h'),$$

and the quadratic equation for the determination of x is

$$b_0 x^2 + 2x[d(b-b_0) + n(F_e + F_e')] = d^2(b-b_0) + 2n(F_e h + F_e' h').$$

* See also Förster, *Fortschritte der Ingenieurwissenschaften*, 1907, No. 13.

When x has been ascertained, the moment of inertia J of the modified section can be computed with regard to the axis NN , and the stresses calculated by the well-known bending formulas. Thus

$$J = \frac{1}{3}[bx^3 - (b-b_0)(d-x)^3] + nF_e'(x-h')^2 + nF_e(h-x)^2,$$

and

$$\sigma_b = \frac{xM}{J}, \quad \sigma_e = \frac{nM}{J}(h-x).$$

An expression can also be obtained for the distance y of the resultant compressive stress above the neutral axis, but the equations given above give a simpler, clearer solution.

Example.—A T-beam of the dimensions shown in Fig. 105 carries a bending moment

$$M = 8,021,000 \text{ kg-cm. (694,732 in.-lbs.)}$$

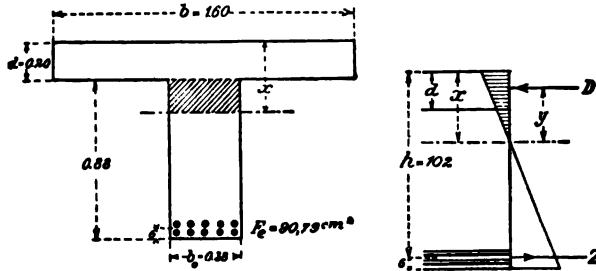

FIG. 105.

1. According to the exact formula. With

$$F_e' = 0, \quad F_e = 10, 34 \text{ mm. (1}\frac{1}{8}\text{ inch approx.) rods} = 90.79 \text{ cm}^2 (14.07 \text{ in}^2),$$

$$b_0 = 38 \text{ cm. (15.0 in.),} \quad b = 160 \text{ cm. (63.0 in.),}$$

$$d = 20 \text{ cm. (7.9 in.),} \quad h = 102 \text{ cm. (40.2 in.),}$$

the equation

$$b_0x^2 + 2x[d(b-b_0) + nF_e] = d^2(b-b_0) + 2nhF_b,$$

becomes

$$38x^2 + 2x(20 \times 122 + 15 \times 90.79) = 20^2 \times 122 + 2 \times 15 \times 102 \times 90.79,$$

$$38x^2 + 7604x = 326,617.$$

Thus

$$x = \frac{-7604 + \sqrt{7604^2 + 4 \times 38 \times 326,617}}{2 \times 38}$$

$$= 36.4 \text{ cm. (14.33 in.);}$$

$$J = \frac{1}{3}(160 \times 36.4^3 - 122 \times 16.4^3) + 15 \times 90.79 \times 65.6^2$$

$$= 8,253,418 \text{ cm}^4 (83,153 \text{ in}^4),$$

so that

$$\sigma_e = 15 \frac{8,021,000 \times 65.6}{8,253,418} = 956 \text{ kg/cm}^2 \text{ (13,598 lbs/in}^2\text{)},$$

$$\sigma_b = \frac{8,021,000 \times 36.4}{8,253,418} = 35.4 \text{ kg/cm}^2 \text{ (504 lbs/in}^2\text{)}.$$

2. Computation omitting compressive stresses in the stem. Then

$$x = \frac{2nhF_e + bd^2}{2(nF_e + bd)} = \frac{2 \times 15 \times 102 \times 90.79 + 160 \times 20^2}{2(15 \times 90.79 + 160 \times 20)} = 37.5 \text{ cm. (14.76 in.)},$$

$$y = x - \frac{d}{2} + \frac{d^2}{6(2x-d)} = 37.5 - 10 + \frac{400}{6(75-20)} = 28.7 \text{ cm. (11.3 in.)},$$

so that

$$\sigma_e = \frac{M}{F_e(h-x+y)} = \frac{8,021,000}{90.79(102-37.5+28.7)} = 946 \text{ kg/cm}^2 \text{ (13,455 lbs/in}^2\text{)},$$

$$\sigma_b = \frac{\sigma_e x}{n(h-x)} = \frac{946 \times 37.5}{15(102-37.5)} = 36.7 \text{ kg/cm}^2 \text{ (522 lbs/in}^2\text{)}.$$

3. Computation according to the simple approximate formulas.

$$\sigma_e = \frac{M}{F_e \left(h - \frac{d}{2} \right)} = \frac{8,021,000}{90.79(102-10)} = 960 \text{ kg/cm}^2 \text{ (13,654 lbs/in}^2\text{)},$$

$$\begin{aligned} \sigma_b &= \frac{\sigma_e (2nhF_e + bd^2)}{n \quad bd(2h-d)} = \frac{960}{15} \frac{(2 \times 15 \times 102 \times 90.79 + 160 \times 400)}{160 \times 20(204-20)} \\ &= 37.2 \text{ kg/cm}^2 \text{ (529 lbs/in}^2\text{)}. \end{aligned}$$

Although in these examples, which are solved for an actual case, the neutral axis falls below the under side of the slab, and b_0 is small compared with b , the two approximate methods 2 and 3 give differences in the stresses σ_e and σ_b scarcely worth mentioning. Their practical value is thus shown. The formulas under number 2, included in the "Leitsätze" and the "Regulations," were first given in the original edition of this book in 1902.

CHAPTER VIII
THEORY OF REINFORCED CONCRETE

BENDING WITH AXIAL FORCES

If the resultant of the external forces intersects the cross-section, the normal components can be replaced by an axial force N and a moment M . If the modulus of elasticity of the concrete is accepted as a constant for the calculations, and, further, as often happens, a compressive force N is involved, two cases are to be distinguished. Consideration will here be given only to rectangular cross-sections, since for irregular sections the graphical treatment given later is preferable.

1. Only compressive stresses are supposed to act over the whole section. By the centroid O of Fig. 106 is understood the centroid of the section produced

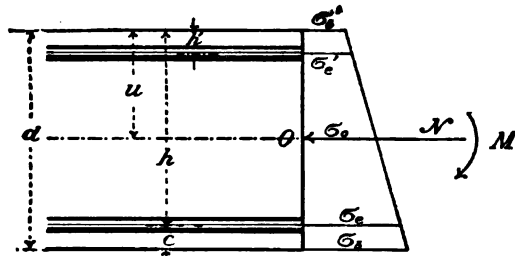

FIG. 106.

when to the concrete area is added that of the reinforcement multiplied by $n = \frac{E_e}{E_b}$.

If for 1 cm. width of section f_e represents the area of steel, so that $f_e = \frac{F_e}{b}$ and

$f_e' = \frac{F_e'}{b}$, the location of the centroid * is given by the formula

$$u = \frac{\frac{d^2}{2} + n(f_e h + f_e' h')}{d + n(f_e + f_e')}$$

The compressive stresses produced by the normal force N acting at the centroid are distributed uniformly over the entire concrete section, so that

$$\sigma_0 = \frac{N}{b d + n(F_e + F_e')}$$

* Below the top layer.—TRANS.

The moment M , with reference to the centroid of the modified section, produces on the one side compressive stresses and on the other side tensile ones. In this case, however, the tensile stresses, since they represent only a decrease in the uniformly distributed compressive stress, are to be calculated as for a homogeneous section, in which the area of reinforcement is to be replaced by a concrete one $\frac{F_e}{E_b}$ times larger. It is thus necessary to calculate the moment of inertia J in the formula

$$\sigma = \frac{vM}{J},$$

from the expression

$$J = \frac{b}{3}u^3 + \frac{b}{3}(d-u)^3 + n F_e(h-u)^2 + nF_e'(u-h')^2.$$

Bending with axial compression is the usual stress condition in the sections of arches. In them the reinforcement is usually symmetrically arranged, so that the centroid of the whole section coincides with the axis of the arch and the calculation assumes a fairly simple form. The area of the modified section is then

$$F = bd + 2 n F_e,$$

and the moment of inertia is

$$J = \frac{b}{12}d^3 + 2 n F_e \left(\frac{d}{2} - c \right)^2.$$

If values are assumed for F and J , the same conditions exist in the reinforced section as regards the rib, as for a homogeneous section.

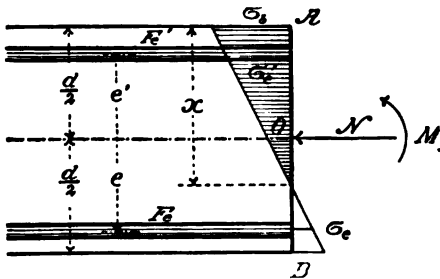

FIG. 107.

2. The resultant is supposed to have such an eccentricity that tensile stresses exist on one side of the section.

If these tensile stresses are insignificant, the calculation may be made exactly as in 1. If, however, they are appreciable, a special modulus of elasticity for tension must be introduced into the calculations. Usually, in order to obtain a proper safety factor, the tensile strength of the concrete is disregarded, as in simple flexure.

In Fig. 107, O represents the centroid of the concrete section to which the moment M is referred, and x is the distance of the neutral axis from the compression edge of the section. Then

$$N = \frac{\sigma_b}{2} b x + F_e' \sigma_c' - F_e \sigma_e, \quad \dots \dots \dots (1)$$

$$M = \frac{\sigma_b}{2} b x \left(\frac{d}{2} - \frac{x}{3} \right) + F_e' \sigma_c' c' + F_e \sigma_e e. \quad \dots \dots \dots (2)$$

Further, because of the conservation of plane sections,

$$\sigma_e = \frac{E_e}{E_b} \sigma_b \frac{e + \frac{d}{2} - x}{x} = n \sigma_b \frac{e + \frac{d}{2} - x}{x}, \dots \dots \dots (3)$$

$$\sigma_e' = \frac{E_e}{E_b} \sigma_b \frac{e' - \frac{d}{2} + x}{x} = n \sigma_b \frac{e' - \frac{d}{2} + x}{x} \dots \dots \dots (4)$$

These four equations suffice for the determination of the four unknowns, x , σ_b , σ_e , σ_e' . If the external forces and given dimensions are used to calculate x the following equation of the third degree results, which can best be solved by trial.

$$\begin{aligned} x^3 \frac{N}{6} - x^2 \left(\frac{Nd}{4} - \frac{M}{2} \right) + \frac{xn}{b} [M(F_e' + F_e) - N(F_e'e' - F_e e)] \\ + \frac{Mn}{b} \left[F_e' \left(e' - \frac{d}{2} \right) - F_e \left(e + \frac{d}{2} \right) \right] \\ - \frac{Nn}{b} \left[F_e'e' \left(e' - \frac{d}{2} \right) + F_e e \left(e + \frac{d}{2} \right) \right] = 0. \end{aligned}$$

Then

$$\sigma_b = \frac{Nx}{\frac{bx^2}{2} + nF_e' \left(e' - \frac{d}{2} + x \right) - nF_e \left(e + \frac{d}{2} - x \right)}$$

As a rule, in arches and columns, the reinforcement is symmetrically arranged, and there are obtained, from equations (1) to (4), with $F_e = F_e'$ and $e' = e$, the following relations:

$$N = \sigma_b \frac{bx}{2} + F_e(\sigma_e' - \sigma_e), \dots \dots \dots (5)$$

$$M = \sigma_b \frac{bx}{2} \left(\frac{d}{2} - \frac{x}{3} \right) + e F_e(\sigma_e' + \sigma_e), \dots \dots \dots (6)$$

$$\sigma_e = n \sigma_b \frac{e + \frac{d}{2} - x}{x}, \dots \dots \dots (7)$$

$$\sigma_e' = n \sigma_b \frac{e - \frac{d}{2} + x}{x}, \dots \dots \dots (8)$$

while the equation for the solution of x takes the form

$$x^3 \frac{N}{6} - x^2 \left(N \frac{d}{4} - \frac{M}{2} \right) + 2x M n \frac{F_e}{b} - n \frac{F_e}{b} (M d + 2N e^2) = 0,$$

or

$$x^3 - 3x^2 \left(\frac{d}{2} - \frac{M}{N} \right) + 12x \frac{M}{N} n \frac{F_e}{b} - 6 \frac{nF_e}{b} \left(\frac{M}{N} d + 2e^2 \right) = 0.$$

This equation may be solved by any approximate method, or directly. If, as is known, there is assumed in the general cubic equation

$$x^3 + ax^2 + bx + c = 0,$$

the new relation $x = z - \frac{1}{3}a$, there is obtained a reduced cubic of the form

$$z^3 + pz + q = 0,$$

from which, according to Cardani's formula, may be derived

$$z = \sqrt[3]{-\frac{1}{2}q + \sqrt{\left(\frac{1}{2}q\right)^2 + \left(\frac{1}{3}p\right)^3}} \\ + \sqrt[3]{-\frac{1}{2}q - \sqrt{\left(\frac{1}{2}q\right)^2 + \left(\frac{1}{3}p\right)^3}}.$$

With the values of equation (9) the reduced cubic becomes

$$z^3 - 3z \left\{ \frac{M^2}{N^2} + d \left(\frac{d}{4} - \frac{M}{N} \right) - \frac{4nF_e M}{b N} \right\} \\ - \frac{1}{2}d^2 \left(\frac{d}{2} - 3\frac{M}{N} \right) - 3\frac{M^2}{N^2} \left(d - \frac{2}{3}\frac{M}{N} + \frac{4nF_e}{b} \right) \\ - \frac{12nF_e e^2}{b} = 0,$$

from which it follows that

$$x = z + \frac{d}{2} - \frac{M}{N}.$$

z here represents the distance of the neutral axis from the point of application of the resultant normal force.

When x is ascertained, the stresses may be found by inserting the value of x in equations (8), (7), (6), and (5), and

$$\sigma_b = \frac{N}{\frac{bx}{2} + \frac{nF_e}{x}(2x-d)}$$

$$\sigma_e = n \sigma_b \frac{e + \frac{d}{2} - x}{x},$$

$$\sigma_e' = n \sigma_b \frac{e - \frac{d}{2} + x}{x}.$$

The process is somewhat complex, and is not simplified when the reinforcement on the compression side is left out of consideration, so that $F_e' = 0$.

In practical cases, especially when the amount of reinforcement must first be determined, a briefer method may be followed: Compute the edge stress as for a homogeneous cross-section without reinforcement, as in the case of a rectangle.

$$\sigma_b = \frac{N}{bd} + \frac{6M}{bd^2},$$

$$\sigma_s = \frac{N}{bd} - \frac{6M}{bd^2}.$$

Then suppose all the tensile stress in the section carried by the reinforcement, the strength of which must therefore be

$$Z = \frac{1}{2} b \sigma_s (d - x).$$

Further (Fig. 108),

$$d - x : \frac{d}{2} = \sigma_s : \frac{6M}{bd^2},$$

so that

$$d - x = \frac{\sigma_s d^3 b}{12M},$$

and

$$Z = \frac{b^2 d^3 \sigma_s^2}{24M}$$

is obtained.

Furthermore, approximately,

$$\sigma_e = \frac{Z}{F_e}.$$

When the edge stress from the rib moment has been obtained, Z can be calculated as the area of the tension surface.

Example.—Assume a rectangular section in which $b = 1$ cm. (0.4 in.) and $d = 90$ cm. (35.4 in.) for which $M = 30,000$ cm-kg (25,984 in-lbs), $N = 660$ kg. (1452 lbs.), $F_e = 0.37$ cm² (0.057 in²) = F_e' , $e = e' = 40$ cm. (15.7 in.), $n = 15$.

According to (9) there is obtained

$$x^3 - 3x^2 \left(\frac{90}{2} - \frac{30,000}{660} \right) + x \times 12 \times \frac{30,000}{660} \times 15 \times \frac{0.37}{1} - 6 \times \frac{15 \times 0.37}{1} \left(\frac{30,000}{660} 90 + 2 \times 40^2 \right) = 0,$$

or

$$x^3 + 1.364x^2 + 3027.3x - 242,773.65 = 0,$$

of which the root, found by the method described above, is

$$x = 46.3 \text{ cm. (18.65 in.)}.$$

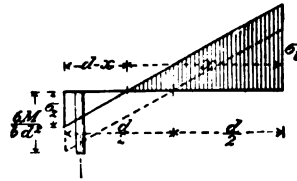

FIG. 108.

From this, according to equation (10), is found

$$\sigma_b = \frac{660}{\frac{46.3}{2} + \frac{0.37 \times 15}{46.3} (2 \times 46.3 - 90)} = 28.2 \text{ kg./cm}^2 \text{ (401 lbs/in}^2\text{)},$$

and according to (7),

$$\sigma_e = 15 \times 28.2 \frac{40 + 45 - 46.3}{46.3} = 354 \text{ kg/cm}^2 \text{ (5035 lbs/in}^2\text{)},$$

$$\sigma_e' = 15 \times 28.2 \frac{40 - 45 + 46.3}{46.3} = 378 \text{ kg/cm}^2 \text{ (5376 lbs/in}^2\text{)}.$$

The approximate method would have given.

$$\sigma_b = \frac{660}{1 \times 90} + \frac{30,000 \times 6}{1 \times 90 \times 90} = 29.6 \text{ kg/cm}^2 \text{ (421 lbs/in}^2\text{)},$$

$$\sigma_e = -14.9 \text{ kg/cm}^2 \text{ (212 lbs/in}^2\text{)},$$

and

$$Z = \frac{b^2 d^3 \sigma_e^2}{24 \cdot M} = \frac{1 \times 90^3 \times 14.9^2}{24 \times 30,000} = 224 \text{ kg. (3186 lbs.)},$$

so that

$$\sigma_e = \frac{224}{0.37} = \text{about } 600 \text{ kg/cm}^2 \text{ (8534 lbs/in}^2\text{)}.$$

The approximate method thus gives an almost identical result for the compressive stress σ_b , but one that is too far at variance for the steel stress σ_e .

For arch ribs, the rib-moments are first to be ascertained by customary methods, and from these moments are then to be computed the axial force N and the moment M with reference to the centroid of any cross-section,*

$$\sigma_o = \frac{+M_{ku}}{W} = \frac{N}{F} + \frac{M}{W},$$

$$\sigma_u = \frac{-M_{ko}}{W} = \frac{N}{F} - \frac{M}{W},$$

from which, through addition and subtraction of these equations,

$$N = \frac{\sigma_o + \sigma_u}{2} F = \frac{M_{ku} - M_{ko}}{2W} F,$$

$$M = \frac{\sigma_o - \sigma_u}{2} W = \frac{M_{ko} + M_{ku}}{2},$$

so that the stresses σ_b and σ_e can be computed exactly.

* W = Section modulus of rib at point in question.

F = Modified area of section.

σ_u = Unit stress of extreme inner layer of rib.

σ_o = Unit stress of extreme outer layer of rib.

M_{ku} = Moment from loading producing stress in inner layer.

M_{ko} = Moment from loading producing stress in outer layer.—TRANS.

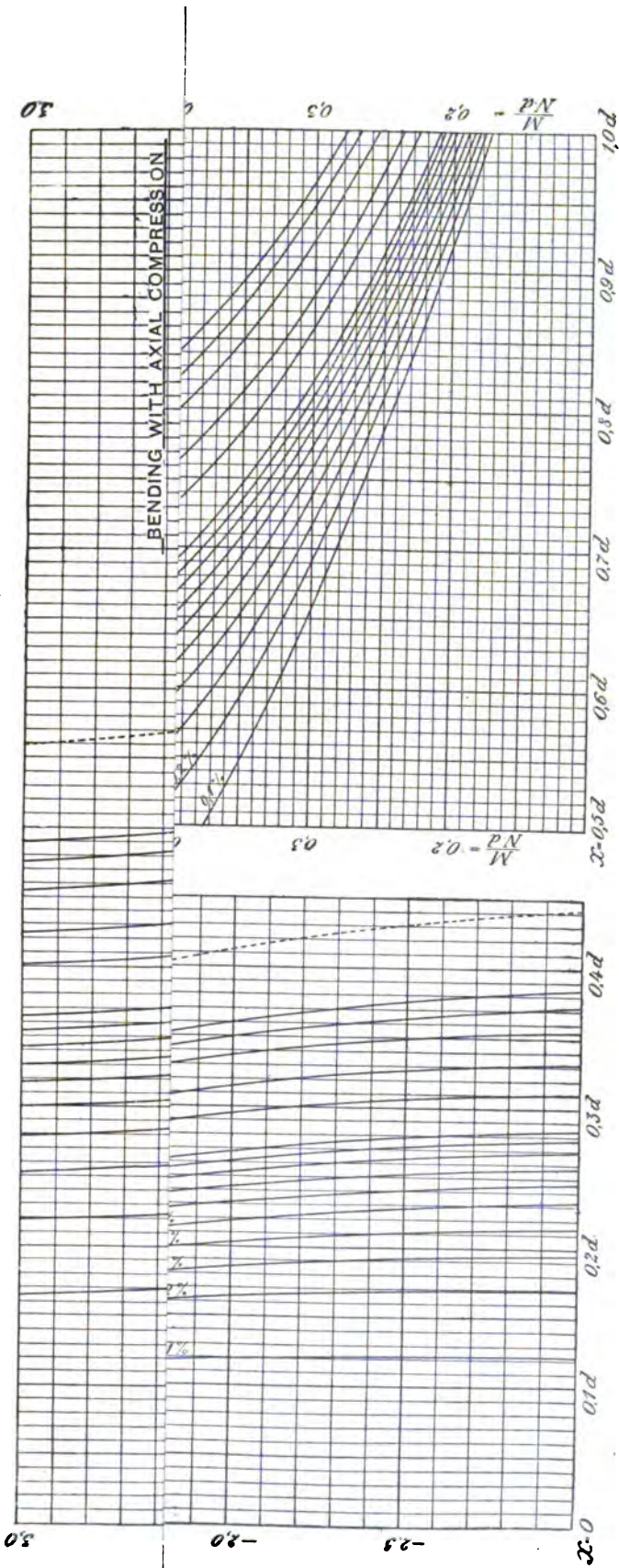

FIG. 109.—Bending with axial stress. Determination of x from $\frac{M}{Nd}$ and μ , for $n=15$, $e=0.42d$.

To face page 124.

Fig. 109 is a diagram which obviates the necessity for the solution of the cubic equation. It is evident from equation (9) that with given measurements, x is dependent only on the ratio $\frac{M}{Nd}$, which represents the eccentricity of the normal force. $\frac{M}{Nd}$ in (9) can therefore be expressed as a function of x and there is obtained

$$\frac{M}{Nd} = \frac{-x^3 + \frac{3}{2}dx^2 + 12\frac{nF_e e^2}{b}}{3x^2 + \frac{12xnF_e}{b} - \frac{6dnF_e}{b}}$$

If the area of reinforcement is expressed in parts of the concrete section, so that

$$F_e = F_e' = \mu b d,$$

and further if

$$e = 0.42d,$$

then, with $n = 15$,

$$\frac{M}{Nd} = \frac{-x^3 + \frac{3}{2}dx^2 + 31.75\mu d^3}{3x^2d + 180\mu d^2 - 90\mu d^3} \dots \dots \dots (11)$$

With assumed percentages of reinforcement, the ratio $\frac{M}{Nd}$ can be computed for various values of x expressed in terms of d , such as $x = 0.1d, 0.2d$, etc. If in a system of coördinates, the values of $x = 0.1d, 0.2d$, etc., are taken as abscissas and as ordinates the values of $\frac{M}{Nd}$ for assumed percentages of reinforcement, curves are obtained. With their help, together with the known values of M and N , and assumed values for d and $F_e = \mu b d$, the distance x of the neutral axis from the compression edge is immediately found in terms of d . The series of curves shown in Fig. 109 is obtained for different percentages of reinforcement of $\mu = 0.001$ to 0.05 , or 0.1% to 5% . These curves permit of ready interpolation of intermediate values of μ . The employment of this table materially facilitates calculation. After x is ascertained the stresses are computed as follows:

$$\sigma_b = \frac{N}{\frac{bx}{2} + \frac{F_e n}{x}(2x-d)} = \frac{2Nx}{bx^2 + 2\mu b d n(2x-d)}$$

$$\sigma_e = n\sigma_b \frac{e + \frac{d}{2} - x}{x} = 15\sigma_b \frac{0.92d - x}{x},$$

$$\sigma_e' = n\sigma_b \frac{e - \frac{d}{2} + x}{x} = 15\sigma_b \frac{x - 0.08d}{x};$$

the last values resulting if e is made equal to $0.42d$.

From the course of the curves, it follows that for certain small values of $\frac{M}{Nd}$, no point of intersection with the curves is possible. In other words, the eccentricity of the compressive force N is then so small that the neutral axis falls outside of the section, and no tensile stress exists in it. The ratio of $\frac{M}{N}$ expresses the distance of the resultant force from the centroid of the cross-section, and it is seen * that the smaller the percentage of reinforcement the nearer the value of x approaches to $\frac{1}{8}d = 0.125d$, while for heavier reinforcement this value is but slightly exceeded. The curves have vertical asymptotes which correspond with the positions of the neutral axis in simple flexure, while a common asymptote for all the curves is the straight line obtained by making $\mu = 0$.

The framing of dimensioning formulas is of little value, because flexure with axial compression occurs in most instances in statically indeterminate structures, such as some arches, trusses, etc., the sections of the parts of which must be assumed so as to calculate the external forces M and N . Consequently, the only operation is the testing of the dimensions chosen. Usually such statically indeterminate structures are calculated with respect to the external forces without regard to the reinforcement of the members, after which the necessary amount of steel is computed by the approximate methods given. The exact determination of the stresses can follow afterwards.

In bending with axial compression the allowable compressive stresses of the concrete and the steel can be simultaneously safely employed only with a certain eccentricity of the normal force. The relation between the value $\frac{M}{Nd}$ of the eccentricity of the normal force and the corresponding percentage of reinforcement μ may be obtained as follows:

For unit stresses $\sigma_b = 40$ and $\sigma_s = 1000$ kg/cm² (569 and 14,223 lbs/in²), and $n = 15$, according to equation (7)

$$x = \frac{3}{8} \left(e + \frac{d}{2} \right),$$

and with

$$F_c = F_s' = \mu b d, \quad \text{and} \quad e = 0.42d$$

there follows from equations (5) and (6)

$$N = 40 b d (0.1725 - 13.478\mu),$$

$$M = 40 b d^2 (0.06641 + 15.34\mu),$$

so that

$$\frac{M}{Nd} = \frac{0.06641 + 15.34\mu}{0.1725 - 13.478\mu}$$

If the values of $\frac{M}{Nd}$ are taken as ordinates, and as abscissas the values of μ

* From the figure.—TRANS.

used in this equation, the curve of Fig. 110 is obtained. For $\frac{M}{Nd} = 0.385 =$

$0.5 - \frac{0.02}{8}$, $\mu = 0$, and reinforcement is unnecessary, as is

naturally also the case with values of $\frac{M}{Nd} < 0.385$. However,

for the sake of safety, some reinforcement should generally be used when the point of application of the normal force falls only $0.115d$ from the edge. And when such eccentricity exists and only insignificant reinforcement is necessary, it is advisable to ignore the theoretical amount and use more steel, since its cost is small, especially when the eccentricity may increase for some unknown reason.

With $\mu = 1.28\%$, a vertical asymptote to the curve exists. That is, at that value $\frac{M}{Nd} = \infty$, or only

pure bending exists. In this case with $e = 0.42d$, the condition is one of flexure in a rectangular section with symmetrically placed double reinforcement.

It is to be noted that from the formulas for bending with axial compression, all those for pure flexure can be secured by making $N = 0$.

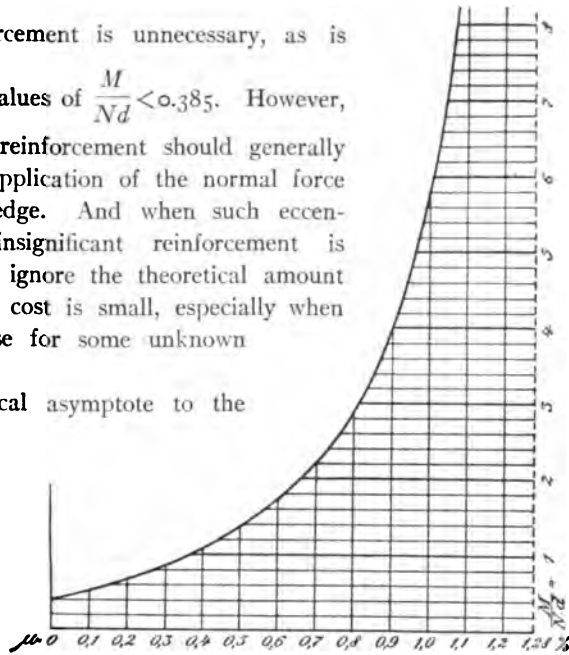

FIG. 110.—Diagram of the relation between the eccentricity of the normal force and the percentage of reinforcement with combined maximum allowable stresses, of $\sigma_s = 1000$, $\sigma_b = 40 \text{ kg/cm}^2$ (14,220 and 569 lbs/in²).

BENDING WITH AXIAL TENSION

In the employment of reinforced concrete for silos, there occurs the condition that an axial tension N acts in addition to a bending moment M . The case of *bending with axial tension* will therefore be discussed.

In Fig. 111, where a rectangular section is assumed of breadth b ,

$$N = F_c \sigma_c - \frac{b \sigma_b}{2} \bar{x} - F_e' \sigma_e',$$

and

$$M = \frac{\sigma_b b x}{2} \left(\frac{d}{2} - \frac{x}{3} \right) + F_e' \sigma_e' e' + F_c \sigma_c e.$$

Further

$$\sigma_c = n \sigma_b \frac{e + \frac{d}{2} - x}{x},$$

$$\sigma_e' = n \sigma_b \frac{e' - \frac{d}{2} + x}{x}.$$

These four equations correspond with the equations (1) to (4) for bending with axial compression, except that N is here introduced as a negative quantity. Thus (with the supposition of symmetrically arranged reinforcement, wherein $F_e = F_e'$ and $e = e'$), there may also be obtained a formula for the calculation of x from equation (9), if N is therein inserted as negative. Then

$$x^3 - 3x^2 \left(\frac{d}{2} + \frac{M}{N} \right) - 12x \frac{M}{N} n \frac{F_e}{b} + 6n \frac{F_e}{b} \left(\frac{M}{N} d - 2e^2 \right) = 0.$$

Further, there is obtained for the calculation of the series of curves which obviate the solution of the cubic equation, the relation

$$\frac{-M}{Nd} = \frac{-x^3 + \frac{3}{2}dx^2 + 31.75\mu d^3}{3x^2d + 180x\mu d^2 - 90\mu d^3}$$

corresponding to equation (11), with the nomenclature there employed. The curves (see Fig. 109) are therefore the branches lying on the negative ordinate side of the axis of abscissas, which correspond with those on the positive side,

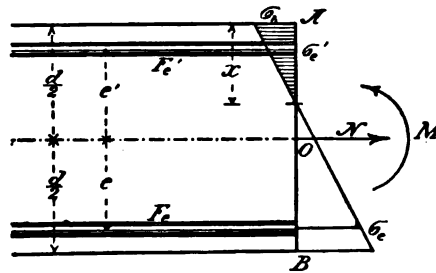

FIG. 111.

and complete each a curve of the third degree. The negative branches have vertical asymptotes in common with the corresponding positive branches and for $x=0$ all curves for different values of μ pass through the point with the ordinate $\frac{M}{Nd} = \frac{31.75}{90}$, under which condition, with $x=0$, the concrete is theoretically useless. In addition, at this point, all the negative branches have a common tangent, the inclination of which is

$$\tan \alpha = \frac{31.75}{45d}.$$

After x is determined, all the stresses can be ascertained from the following formulas:

$$\sigma_b = \frac{-2Nx}{bx^2 + 2\mu bdn(2x-d)},$$

$$\sigma_e = 15\sigma_b \frac{0.92d - x}{x},$$

$$\sigma_e' = 15\sigma_b \frac{x - 0.08d}{x}.$$

In flexure with axial tension also, Z and σ_e can be calculated approximately by the formulas

$$Z = \frac{b^2 d^3 \sigma_e^2}{24M},$$

$$\sigma_e = \frac{Z}{F_e},$$

from which flexure with axial compression is computed.

For values of $\frac{M}{Nd}$ smaller than $\frac{31.75}{90} = 0.3528$, the axis falls outside the section and the tensile force N is then to be divided according to the law of the lever, if the condition that the concrete is to carry no tension is maintained. Table XXX gives a comparison between results obtained by the exact and the approximate methods.

TABLE XXX

| Kind. | b | | d | | M | | N | | $\frac{M}{Nd}$ | e | | $F_e = F_e'$ | |
|--------------------------------|-----|-----|------|------|---------|----------|-------|------|----------------|-------|-----|-----------------|-----------------|
| | cm. | in. | cm. | in. | kg.-cm. | in.-lbs. | kg. | lbs. | | cm. | in. | cm ² | in ² |
| Bending with axial compression | 1 | 0.4 | 50 | 19.7 | 7500 | 6496 | 500 | 1102 | 0.30 | 21 | 8.3 | 0.15 | 0.023 |
| | 1 | 0.4 | 50 | 19.7 | 12500 | 10826 | 500 | 1102 | 0.50 | 21 | 8.3 | 0.15 | 0.023 |
| | 1 | 0.4 | 50 | 19.7 | 15000 | 12991 | 300 | 661 | 1.00 | 21 | 8.3 | 0.30 | 0.046 |
| Bending with axial tension | 1 | 0.4 | 16.5 | 6.5 | 1520 | 1316 | 45.6 | 1005 | 2.02 | 6.92 | 2.7 | 0.165 | 0.026 |
| | 1 | 0.4 | 12.0 | 4.7 | 713 | 617 | 25.6 | 564 | 2.32 | 5.00 | 2.0 | 0.103 | 0.016 |
| | 1 | 0.4 | 27.0 | 10.6 | 4000 | 3464 | 106.4 | 2346 | 1.40 | 11.35 | 4.5 | 0.290 | 0.045 |

| Kind. | μ | x | | Exact. | | | | Approximate. | | | |
|--------------------------------|--------|------|------|--------------------|---------------------|--------------------|---------------------|--------------------|---------------------|--------------------|---------------------|
| | | | | σ_b | | σ_e | | σ_b | | σ_e | |
| | | cm. | in. | kg/cm ² | lbs/in ² | kg/cm ² | lbs/in ² | kg/cm ² | lbs/in ² | kg/cm ² | lbs/in ² |
| Bending with axial compression | 0.003 | 35.8 | 14.1 | 25.9 | 368 | 110 | 1565 | 28.0 | 398 | 296 | 4210 |
| | 0.003 | 23.3 | 9.2 | 44.2 | 629 | 618 | 9217 | 40.0 | 569 | 1110 | 15787 |
| | 0.006 | 19.8 | 7.8 | 39.5 | 562 | 782 | 11122 | 42.0 | 597 | 1041 | 14806 |
| Bending with axial tension | 0.0100 | 4.45 | 1.75 | 22.8 | 324 | 826 | 11748 | 30.7 | 437 | 982 | 13967 |
| | 0.0086 | 3.20 | 1.26 | 23.1 | 329 | 850 | 12090 | 27.6 | 393 | 997 | 14180 |
| | 0.0107 | 6.75 | 2.66 | 20.1 | 286 | 820 | 11663 | 29.0 | 413 | 923 | 13138 |

The last three cases represent practical examples of silos actually erected.

The results of the calculations can be readily tested as to their accuracy by introducing numerical values in equations (5) and (6) and noting whether the equations are satisfied.

GRAPHICAL METHODS OF CALCULATION

All the foregoing discussion applied primarily to rectangular or T-shaped sections. It is quite possible, however, that sections of other shapes may occur—circular, annular, etc. For such cases, the formulas to be deduced would be very complex at best. The following graphical methods are therefore recommended. They lead directly to the desired result in a simple manner and for any desired form of section. In the two methods given on pages 12 and 13, a treatise by Autenrieth * of Stuttgart will be followed.

(a) *Simple Bending*.—If no normal force acts on a reinforced concrete section, only a bending moment M existing; and on the assumption that sections of steel after deformation remain in the corresponding planes with the compressed concrete sections; and from the equality of the tensile and compressive forces,—it follows that the neutral axis (which at the same time limits the compression zone of the concrete section) is the centroidal axis of the area consisting of the compressed part of the section and the n -fold increased steel section on the tension side. (See also page 81.)

This surface is known as the modified cross-section. It follows, moreover, that for this modified section, the stresses can be calculated according to Navier's bending formula

$$\sigma = \frac{vM}{J},$$

since the quantities are identical with those of a homogeneous cross-section, wherein the area of the tensile steel is replaced by an n -fold greater concrete area. The stress on the steel is then

$$\sigma_e = n \sigma = n \frac{vM}{J},$$

where J is the moment of inertia of the imaginary area, computed for the neutral axis passing through the centroid.

For a symmetrical, otherwise unrestricted cross-section, the axis of symmetry of which falls in the plane of the forces, two force polygons I and II , with equal polar distances H , are to be drawn, starting from B and A , so as to make a line polygon (Fig. 112). The loads which form the line polygon BD for the zone of compression are to be made up from strips of the compressed area taken perpendicular to the axis of symmetry, and in the polygon AD for the zone of tension, of the n -fold increased area of the reinforcement. When reinforcement is found in the zone of compression, as may often occur, the polygon BD is to include the n -fold increased steel area, beside the strip in which

* "Berechnung der Anker, welche zur Befestigung von Platten an ebenen Flächen dienen." *Zeitschrift des Vereins Deutscher Ingenieure*, 1887. The treatise does not relate directly to reinforced concrete, but the conditions are identical with those here discussed, so that the methods can be applied, without change, to reinforced concrete.

it acts. Now it is known that the moment of a system of parallel forces with respect to a parallel straight line is equal to the portion of the straight line inter-

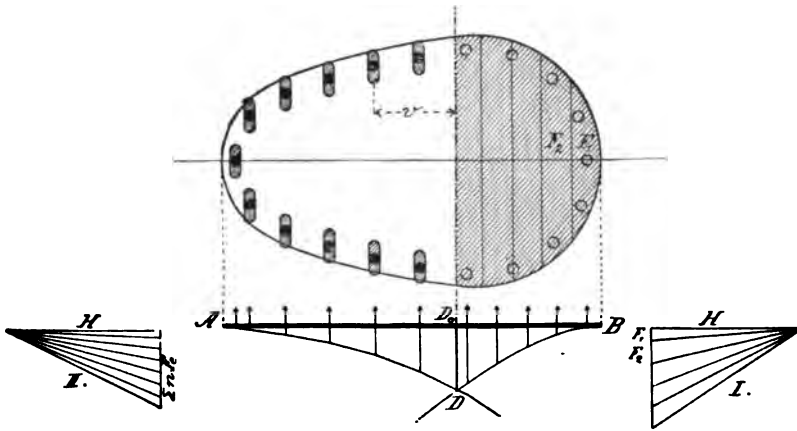

FIG. 112.

cepted by the two external sides of a line polygon, multiplied by the horizontal, H , of such line polygon. Thus, referring to Fig. 113

$$M = P_1 a_1 + P_2 a_2 + P_3 a_3 = yH,$$

and applying it to Fig. 112, there is obtained for the line D_0D , passing through the point of intersection of the two line polygons, moments of equal size for the right and left areas. In other words, the centroidal axis and the neutral axis both pass through the point of intersection D , of both line polygons.

To determine the stresses according to the formula

$$\sigma = \frac{v M}{J},$$

the moment of inertia J of the modified section about the centroidal line is required. For irregular areas it must be determined graphically. According to the method given by Mohr,* the moment of inertia in this case is

$$J = 2H \times \text{area } ADB,$$

so that all the quantities required for the computation of the stress are known.

* In Fig. 113, the moment of inertia of the forces is equal to the area enclosed by the line polygon, the axis of inertia and the first external side of the line polygon, multiplied by $2H$.

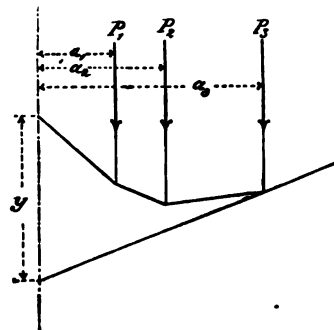

FIG. 113.

Applied to a rectangular cross-section, a straight line is obtained for the line polygon starting from A , and a parabola for that starting from B . The computation of their point of intersection leads again to the equation of the second degree, already given. Further, with $H=1$ and $b=1$, the distance

$$D_0D = \frac{x^2}{2},$$

and

$$J = 2 \frac{(h-x)x^2}{2} + 2 \times \frac{1}{3} \times \frac{x^3}{2} = \frac{x^2}{2} \left(h - \frac{x}{3} \right),$$

so that

$$\sigma_b = \frac{xM}{J} = \frac{2M}{x \left(h - \frac{x}{3} \right)}.$$

Consequently, the same value is obtained as with $b=1$, in the formula previously given.

(b) *Bending with Axial Compression. First Method.* The point of application of the normal force N is supposed to act at C on the axis of symmetry

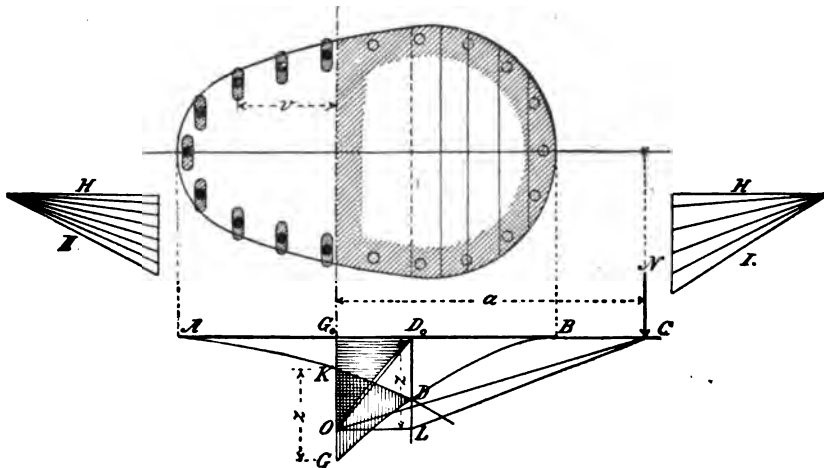

FIG. 114.—(According to Autenrieth.)

(Fig. 114). In a similar manner as above described, the two line polygons AD and $B DG$ are drawn, wherein the latter also includes some steel which would be within the zone of compression.* In distinction from the case of pure flexure, the neutral axis is shifted from D_0 to G_0 . If the distance of any area element of the modified cross-section from the neutral axis through G_0 is designated v , the following conditions of equality are obtained:

$$N = \Sigma \sigma \times dF = \frac{\sigma}{v} \times \Sigma dF \times v.$$

(Equation for vertical component)

* If the force N did not exist.—TRANS.

$$Na = \Sigma dF \times \sigma v = \frac{\sigma}{v} \Sigma dF \times v^2.$$

(Moment equation about neutral axis)

Through a combination of the two there results

$$a \frac{\sigma}{v} \Sigma dF \times v = \frac{\sigma}{v} \Sigma dF \times v^2,$$

from which

$$a = \frac{J'}{M'}.$$

J' here designates the moment of inertia of the modified section and M' its statical moment, with reference to the neutral axis sought. Both quantities can be represented graphically by using the curves previously drawn.

Now

$$J' = 2 H \times \text{area } ABDGK,$$

or designating the area by f ,

$$J' = 2 H f.$$

Further

$$M' = H \times KG = H z,$$

so that

$$a = \frac{2f}{z},$$

or

$$\frac{az}{2} = f.$$

This equation provides a method of locating the neutral axis. By laying off from the line AB (Fig. 114) the ordinate differences z between the curves AD and BG , the curve D_0O , starting from D_0 is obtained, and the two shaded areas will be equal. If D_0L is made of such size that the triangle $D_0LC = \text{area } ABD = \text{triangle } D_0OC$, it follows that $\frac{az^*}{2}$ (that is, the area of the triangle G_0CO) is

almost equal to the area f . It is actually too large by the area enclosed between the arc and the chord D_0O . The position G_0 of the neutral axis, therefore, still requires a slight correction. If (Fig. 115) such a piece COO' is cut off from the triangle G_0OC , starting from C , that its area equals that bounded by the arc and chord OD_0 , then the neutral axis sought will pass through O' , because the

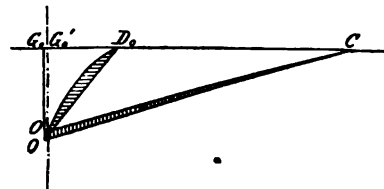

FIG. 115.

* Find $z = \frac{2f}{D_0C}$ by measurement.—TRANS.

area f has lost only the strip $G_0G_0'O'O$, so that the quantity $\frac{G_0'C \times G_0'O'}{2}$ is equal to the new area f .

After the position of the neutral axis has been determined in this manner, the normal stress σ at any desired point in the section can finally be found.

$$\sigma = \frac{v N}{\sum dF \times v} = \frac{v N}{M'} = \frac{v N}{H z},$$

or also

$$\sigma = \frac{v N a}{J'} = \frac{v N a}{2 H f}.$$

For the tensile stress in the reinforcement, there is found

$$\sigma_e = n \sigma = \frac{n v N}{H z}.$$

The distances v and a , as well as z , are to be determined from the corrected position of the neutral axis.

*Second Method.** The following is a simpler method than that of Mohr, for ascertaining the unit stresses in a homogeneous section subjected to bending loads outside the section itself, and in which tension is excluded, such as may be adopted for reinforced concrete columns.

If the point of application C of the normal force N lies on the axis of symmetry of the section, at a distance a from the neutral axis, then, as before,

$$a = \frac{J'}{M'},$$

where J' is the moment of inertia of the modified section, and M' is the statical moment about the neutral axis being sought. In Fig. 116, the line polygon $A'B'A''$ is so drawn for the force polygon on the left, with a polar distance H , that the portion $A'B'$ belongs to the n -fold steel section, while the portion $B'A''$ is for the strips F_b of the concrete section. If GK is the true position of the neutral axis, then the statical moment of the effective modified area, that is, of the n -fold increased steel areas and the concrete area lying to the right of the axis, is

$$M' = H z.$$

Then, in the line polygon of the effective section $C'A'$ is the first external side, and the side through G is the last external side.

* C. Guidi, "Sul calcolo delle sezioni in beton armato." Cemento, 1906, No. 1.

The moment of inertia of the effective modified section is

$$J' = 2H \times \text{area } A'B'GK;$$

so that

$$a = \frac{J'}{M'} = \frac{2 \times \text{area } A'B'GK}{z},$$

and

$$\frac{az}{2} = \text{area } A'B'GK.$$

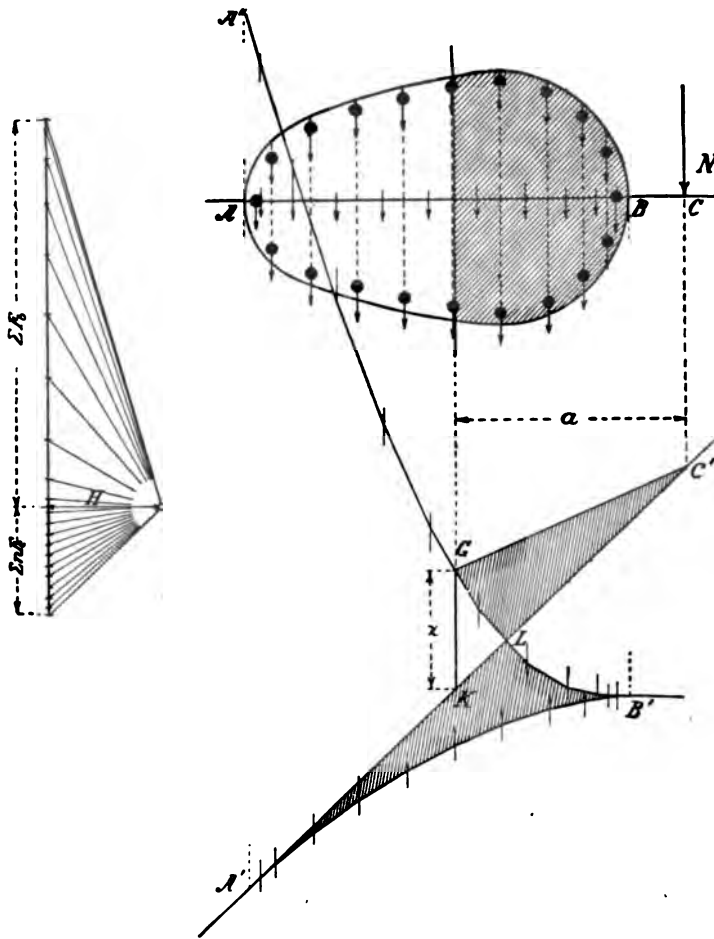

FIG. 116.

Now, $\frac{az}{2}$ is also equal to the area of the triangle $C'GK$. Hence, necessarily

$$C'GK = A'B'GK.$$

This is the case when the two shaded areas are equal.

To locate the point G it is necessary to draw from the point C' , located under

C on the first external side of the line polygon, a straight line $C'G$, so that the shaded areas equal each other; that is, so that

$$C'LG = A'B'L.$$

Since the area of the figures $A'B'L$ is known, the point G can be easily and exactly determined, if the difference is computed which a slight displacement makes in the value of the shaded area, derived from first locating the point tentatively according to judgment.

When the location of the axis has been fixed, the unit stresses may be computed with the aid of the formulas of the first method,

$$\sigma = \frac{vN}{\sum dF \times v} = \frac{vN}{M'} = \frac{vN}{Hz'}$$

and

$$\sigma_e = n\sigma,$$

v being the distance from the neutral axis to the extreme layer.

The second method seems somewhat plainer than the first. If desired, the steel found within the compression side can be ignored, and then in the line polygon $B'A''$, simply the steel section can be treated, as shown in Fig. 117.

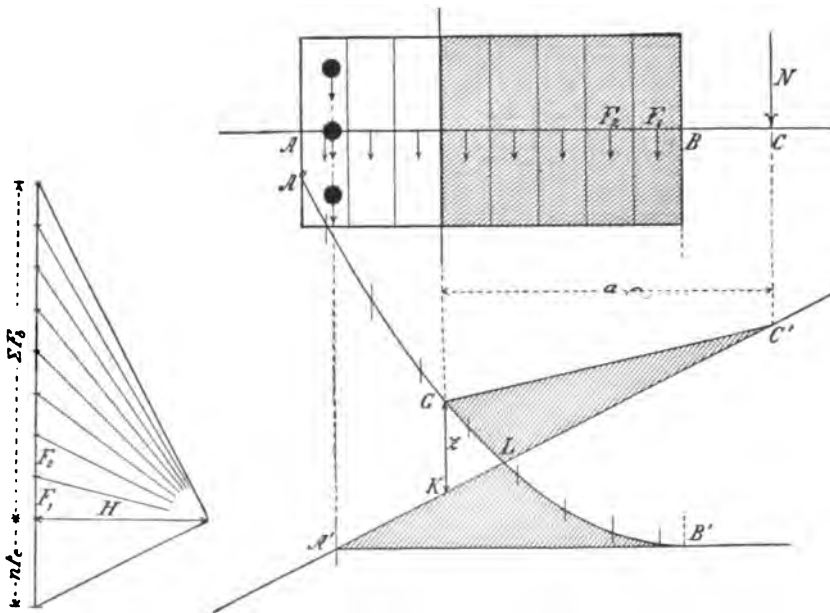

FIG. 117.

This second method is very simple when applied to the rectangular section there shown. The line polygon $A'B'$ is simply a straight line, and $B'A''$ is a parabola.

It should be noted that the graphical methods under (a) and (b) can also be applied to those forms of reinforcement in which the dimensions in a direction

parallel to that in which the forces act are so large that the moment of inertia of the steel section must be included. The section of the reinforcement is then to be considered as a concrete area composed of narrow strips n -times as wide in a direction parallel with the neutral axis, in order to construct the line polygon $A'B'$.

These larger sections of reinforcement are T, I and \lfloor -bars such as are used, for instance, in the Melan system.

METHOD OF COMPUTATION FOR STAGE IIa

For the sake of completeness, and in order to gain some insight into the difficulties attending the exact analytical inquiry as to deformations, the following method of computation for rectangular sections for Stage IIa is given:

From Figs. 92 to 94 on pages 100 and 101, it is seen that the curves of stress in Stage II for rectangular reinforced-concrete sections, can be closely approximated by two straight lines, one of which passes through the neutral axis of the section and is prolonged into the tension side until the tensile stress reaches a value σ_z equal to the tensile strength of the concrete, from which point it becomes parallel with the line representing the cross-section.

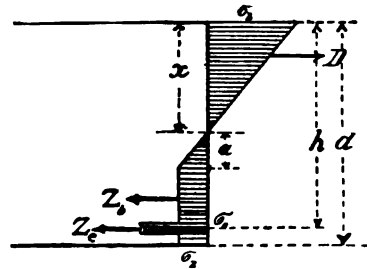

FIG. 118.

With the nomenclature of Fig. 118, for simple flexure,

$$D = Z_e + Z_b,$$

or

$$\frac{b\sigma_b}{2}x = F_c\sigma_e + Z_b,$$

$$Z_b = \left(d - x - \frac{a}{2}\right)b\sigma_z,$$

$$a = \frac{x\sigma_z}{\sigma_b};$$

whence $Z_b = \left(d - x - \frac{x\sigma_z}{2\sigma_b}\right)b\sigma_z$, so that since $\sigma_e = n\sigma_b \frac{(h-x)}{x}$,

$$\frac{b\sigma_b}{2}x = \frac{F_c n \sigma_b (h-x)}{x} + \left(d - x - \frac{x\sigma_z}{2\sigma_b}\right)b\sigma_z.$$

For a given value of the ratio

$$\frac{\sigma_z}{\sigma_b} = \beta,$$

x may be determined as follows,

$$\frac{bx}{2} = F_c n \frac{(h-x)}{x} + \left(d - x \left[1 + \frac{\beta}{2}\right]\right)b\beta,$$

or

$$x^2(1 + \beta)^2 + 2x\left(\frac{F_c}{b}n - d\beta\right) = \frac{F_c}{b}nh,$$

whence

$$x = \frac{-\left(\frac{F_c n}{b} - d\beta\right) + \sqrt{\left(\frac{F_c n}{b} - d\beta\right)^2 + \frac{F_c}{b} n h (1 + \beta)^2}}{(1 + \beta)^2}$$

The location of the neutral axis is thus determined. Further, then,

$$M = F_c \sigma_c \left(h - \frac{x}{3}\right) + b \sigma_z (d - x) \left(\frac{2}{3}x + \frac{d - x}{2}\right) - \frac{b \sigma_z}{2} a \left(\frac{2}{3}x + \frac{1}{2}a\right),$$

$$\frac{M}{b} = \frac{F_c n}{b} \sigma_b (h - x) \left(h - \frac{x}{3}\right) + \beta \sigma_z (d - x) \left(\frac{d}{2} + \frac{x}{6}\right) - \frac{\beta}{6} \sigma_b x \beta (2x + x\beta),$$

whence

$$\sigma_b = \frac{6Mx}{nF_c(h-x)(6h-2x) + xb\beta(d-x)(3d+x) - b\beta^2x^3(2+\beta)}$$

If the formulas are applied to the test specimen described on page 99 with 0.4% of reinforcement, and on the assumption that $n=10$, and for a breadth of 15 cm., the following values are obtained:

| | | |
|------------------------------------|--|---|
| $M = 15 \times 3659 \text{ cm-kg}$ | $\text{With } \beta = \frac{1}{3} \left\{ \begin{array}{l} x = 11.4 \text{ cm.} \\ \sigma_b = 28.0 \text{ kg/cm}^2 \\ \sigma_z = 9.3 \text{ kg/cm}^2 \\ \sigma_c = 376 \text{ kg/cm}^2 \end{array} \right.$ | $\text{measured } \left\{ \begin{array}{l} x = 12.4 \text{ cm.} \\ \sigma_b = 28.5 \text{ kg/cm}^2 \\ \sigma_z = 9.5 \text{ kg/cm}^2 \\ \sigma_c = 288 \text{ kg/cm}^2 \end{array} \right.$ |
| $M = 15 \times 5326 \text{ cm-kg}$ | $\text{With } \beta = \frac{1}{3} \left\{ \begin{array}{l} x = 9.02 \text{ cm.} \\ \sigma_b = 49.7 \text{ kg/cm}^2 \\ \sigma_z = 9.97 \text{ kg/cm}^2 \\ \sigma_c = 978 \text{ kg/cm}^2 \end{array} \right.$ | $\text{measured } \left\{ \begin{array}{l} x = 9.6 \text{ cm.} \\ \sigma_b = 48.3 \text{ kg/cm}^2 \\ \sigma_z = 9.5 \text{ kg/cm}^2 \\ \sigma_c = 842 \text{ kg/cm}^2 \end{array} \right.$ |

With the exception of σ_c the results agree in a satisfactory manner. It is seen that the computed position of the neutral axis changes with an increase of bending moment, and consequently the decreasing ratio $\frac{\sigma_z}{\sigma_b} = \beta$ affects its position.

The limiting value with $\beta=0$ corresponds with the computations for Stage IIb. In a beam loaded in the customary manner, so that the bending moment increases towards the center, the locus of the neutral axes through the various sections rises toward the middle of the beam. At the instant when cracks appear, it will have reached a culminating point, which will be lower in proportion to the average position of the line, the higher are the stresses.

CHAPTER IX
THEORY OF REINFORCED CONCRETE
EFFECTS OF SHEARING FORCES

WHILE in rectangular steel beams the shearing stresses play small part and need be computed only in exceptional cases, in reinforced concrete beams they are of considerable importance and must be considered in the arrangement of the reinforcement. In reinforced T-beams in which only straight rods are employed, when bending takes place (provided the reinforcement is strong enough), the break does not occur near the center of the beam through tensile



FIG. 119.—Failure cracks in the vicinity of the points of support of a concrete T-beam reinforced with only straight round rods.

stresses, but near the points of support where inclined cracks form, due to the shearing stresses or the diagonal principal ones generated by them. Such cracks are shown in Figs. 119 and 120.

In homogeneous beams possessing a constant modulus of elasticity, the diagonal principal stresses, that is, the maximum values of the tensile and compressive stresses in any inclined elemental area, are given by the formulas

$$\sigma = \frac{\sigma}{2} + \sqrt{\frac{\sigma^2}{4} + \tau^2},$$
$$\sigma_{11} = \frac{\sigma}{2} - \sqrt{\frac{\sigma^2}{4} + \tau^2},$$

and their direction by

$$\tan 2\alpha = -\frac{2\tau}{\sigma}$$

The expression

$$\pm \sqrt{\frac{\sigma^2}{4} + \tau^2}$$

represents the limiting value of the shearing stress. The elemental areas in which the tensile and compressive stresses act, and in which the shear is zero,



FIG. 120.—Failure cracks in the vicinity of the points of support of a T-beam reinforced with straight Thatcher bars.

make with those in which the maximum shearing stresses act, an angle of 45° . If, from point to point of a beam, the direction of the greatest (or least) principal stresses at those points be followed, two series of mutually perpendicular curves are traced, which are called trajectories of the principal stresses.

In Fig. 121 is given a diagram of the trajectories of the principal stresses for a simple, freely supported, homogeneous beam of T-section. All curves cut the neutral axis at 45° , at which point $\sigma=0$ and $\sigma_1=\tau_0$. If the tensile strength is less than the shearing strength, as is the case for concrete, then the break will occur in consequence of the tensile stress σ_1 , and the real shearing strength will not be developed.

However, it cannot be finally determined that the best form of reinforcement is that which will follow the direction of the trajectory of the principal tensile stress. This point becomes evident upon working out this idea, especially with regard to continuous beams with variable loads, in which the distribution of stress in a section is different in a reinforced from a homogeneous

beam. The principal stresses are also influenced by vertical pressures between the various separate concrete layers.

At all points in a beam where $\sigma_z = 0$, as at the supports of simple ones and at the points of zero moment of continuous ones, $\alpha = 45^\circ$. At these points the reinforcement should be bent at a 45° angle if it is to conform to the conditions, so that it can take up to the best advantage the diagonal tension stresses, which are then equal to τ . As the middle is approached α , however, becomes smaller than 45° , so that flatter bends are advisable down to 30° .

In adopting Stage I as a basis of computation, the value of the shearing stress τ is an approximation for the section with $\sigma_z = 0$.

In the "Leitsätze" and the "Regulations," it is required that the horizontal tensile stress σ_z of the concrete is to be wholly carried by the lower reinforcement, so that in the calculation of the shearing stresses the tension in the concrete is wholly ignored. The diagonal tensile stresses produced by the shearing stresses should be carried by stirrups and bent rods. Since actual structures and test specimens built in this way have proven satisfactory, the simple method of com-

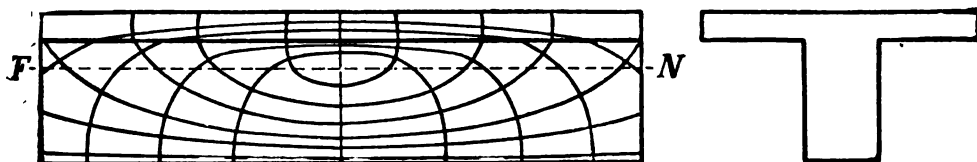

FIG. 121.—Stress trajectories in a homogeneous T-beam.

puting the shearing stresses according to Stage IIb will be adopted, and an explanation given of the various formulas, followed by a careful application to the experimental data at hand, in order to ascertain what factor of safety is provided against a failure in the shearing strength. Finally, will be considered Considère's theory of the great extensibility of reinforced concrete, under the influence of which the "Leitsätze" was prepared, but which has been found untenable in practice and has received certain modifications.

FORMULAS FOR SHEARING AND ADHESIVE STRESSES

In the same way in which the tensile strength of concrete is ignored in bending, the formulas for shear and adhesion will be derived on the assumption that the stresses σ_b and σ_c are equally effective in cracked sections as in all others. Further, only plain reinforcement will be considered.

1. Rectangular section with simple plain reinforcement on the tension side.

The normal stresses are to be found for Stage IIb according to method No. 3 of page 80. Let AB and $A'B'$ be two adjacent sections between which on the plane CC' are applied shearing stresses equal in amount to the difference between the normal stresses on AC and $A'C'$. Then

$$\tau \times b \times dl = \int_v^x b \times dv \times d\sigma.$$

It has already been shown (page 81) that

$$\sigma_b = \frac{2M}{b\left(h - \frac{x}{3}\right)x},$$

from which

$$\frac{d\sigma_b}{dl} = \frac{2}{bx\left(h - \frac{x}{3}\right)} \frac{dM}{dl} = \frac{2Q}{bx\left(h - \frac{x}{3}\right)},$$

wherein Q represents the total of the external forces acting on one side of the section. From the diagram of Fig. 122,

$$d\sigma = \frac{v}{x} d\sigma_b,$$

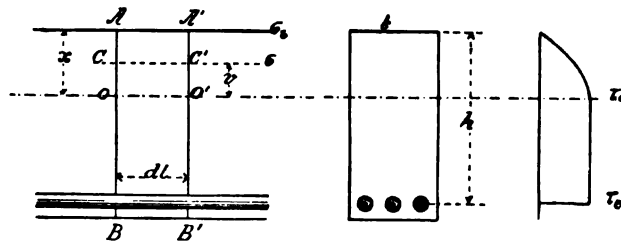

FIG. 122.

so that

$$\tau b \times dl = \int_v^x b \times dv \times \frac{2vQ \times dl}{bx^2\left(h - \frac{x}{3}\right)},$$

$$\tau b = \frac{2Q}{x^2\left(h - \frac{x}{3}\right)} \int_v^x v \times dv,$$

$$\tau b = \frac{Q(x^2 - v^2)}{x^2\left(h - \frac{x}{3}\right)}.$$

Consequently, on the top layer where $v=x$, the shearing stress is zero and increases toward the neutral axis to

$$\tau_0 = \frac{Q}{\left(h - \frac{x}{3}\right)b}.$$

The expressions for τb and τ_0 may also be obtained, if in the regular formula for homogeneous sections,

$$\tau = \frac{QS}{Jb},$$

is substituted the modified section consisting of the compressed concrete and the n -times increased steel area. For the computation of τ_0 , the value S of the statical moment of the compressed concrete with reference to the zero axis is

$$S = \frac{bx^2}{2},$$

and the moment of inertia is

$$J = \frac{1}{3}bx^3 + nF_e(h-x)^2,$$

so that

$$\tau_0 = \frac{Q \frac{bx^2}{2}}{b(\frac{1}{3}bx^3 + nF_e(h-x)^2)}.$$

It follows, however, from the quadratic equation for the determination of x , that

$$F_e = \frac{b}{2n} \frac{x^2}{h-x},$$

so that finally as before

$$\tau_0 = \frac{Q}{b \left(h - \frac{x}{3} \right)}.$$

According to the assumptions made for Stage IIb, no normal stress acts in the concrete below the neutral axis, the whole tensile forces being taken by the reinforcement. With this supposition, the shearing stress τ_0 is constant between the line OO' and the reinforcement. In that case it is evident that the shearing stress τ_0 is also equal to the difference in the tensile stress between two adjacent sections of the reinforcement.

Hence it follows that

$$b\tau_0 \times dl = dZ;$$

$$Z = \frac{M}{h - \frac{x}{3}},$$

$$\frac{dZ}{dl} = \frac{dM}{dl} \frac{1}{\left(h - \frac{x}{3} \right)^2} = \frac{Q}{h - \frac{x}{3}},$$

so that

$$b\tau_0 = \frac{Q}{h - \frac{x}{3}}.$$

This value of $b\tau_0$ also represents the total effective adhesive stress on unit length of the circumference of the steel, and consequently the adhesive stress τ_1 is

$$\tau_1 = \frac{b\tau_0}{\text{total circumference of the reinforcement}}$$

Example. A reinforced concrete slab with $F_e = 6.79 \text{ cm}^2$ (1.05 in^2) = 6 rods 12 mm. ($\frac{1}{2}$ in. approx.) in diameter, has a span of 2.0 m. (6.56 ft.) and carries a load of 820 kg/m^2 (168 lbs/ft^2). In it $h = 9 \text{ cm}$. (3.54 in.). The distance of the neutral axis from the upper layer, computed according to formulas already given, is

$$x = 3.38 \text{ cm. (1.33 in.)}$$

Further, for $b = 100 \text{ cm. (39.4 in.)}$,

$$Q = 820 \text{ kg. (1704 lbs.)}$$

Hence

$$100\tau_0 = \frac{820}{\left(9 - \frac{3.38}{3}\right)} = 104 \text{ kg/cm}^2 \text{ (1479 lbs/in}^2\text{)},$$

$$\tau_0 = 1.04 \text{ kg/cm}^2 \text{ (14.8 lbs/in}^2\text{)}.$$

Since the reinforcement per meter width consists of 6 rods 12 mm. in diameter, the total circumference is

$$U = 6 \times 3.14 \times 1.2 = 22.6 \text{ cm. (8.9 in.)}$$

and the adhesive stress

$$\tau_1 = \frac{104}{22.6} = 4.6 \text{ kg/cm}^2 \text{ (65.4 lbs/in}^2\text{)}.$$

In simple slabs the shearing and adhesive stresses are usually so small that their computation seems unnecessary. For the same reasons, stirrups in simple slabs are deemed superfluous.

Of more importance are the shearing and adhesive stresses in

2. T-beams. It is evident that the expression in the last section

$$b\tau_0 = \frac{Q}{h - \frac{x}{3}},$$

which applies to rectangular sections, is also applicable to T-sections when the distance of the reinforcement from the centroid of compression (Fig. 101, page

108) is substituted for $h - \frac{x}{3}$, and for b the width of the stem b_0 is used. For $x < d$ the expression remains the same, while for $x > d$ (Fig. 102, page 109),

$$\tau_0 = \frac{Q}{(h - x + y)b_0}$$

is to be used. Approximately, the somewhat too small value $h - \frac{d}{2}$ may be used, so that for the distance of the centroid of compression from the reinforcement,

$$\tau_0 = \frac{Q}{\left(h - \frac{d}{2}\right)b_0},$$

(which is slightly too large) is the shearing stress in the stem between the reinforcement and the neutral plane.

Example. For the freely supported T-beam of Example 1, page 111,

$$l = 5.5 \text{ m. (18.0 ft.)},$$

$$q = 3780 \text{ kg/m (2535 lbs/running ft.)}.$$

Thus,

$$Q = 2.75 \times 3780 = 10,395 \text{ kg. (22,869 lbs.)},$$

$$\tau_0 b_0 = \frac{10,395}{57 - 13.1 + 9.1} = 196 \text{ kg/cm},$$

and the shearing stress in the stem is

$$\tau_0 = \frac{196}{28} = 7.0 \text{ kg/cm}^2 \text{ (99.6 lbs/in}^2\text{)}.$$

If all five of the 28 mm. (1½ in. approx.) rods were carried to the support, the adhesive stress at that point would be

$$\tau_1 = \frac{196}{5 \times 3.14 \times 2.8} = 4.5 \text{ kg/cm}^2 \text{ (64.0 lbs/in}^2\text{)}.$$

The foregoing formulas for the shearing stress are deduced on the assumption that no tensile stresses act on the concrete below the neutral axis. It is to be noted, however, that in both Stage I and IIa, where the concrete yet carries some tension, the compressive force $D = \frac{M}{z}$, where z is the distance between Z and D . Furthermore, the horizontal shearing force at the level of the neutral

axis between two adjacent sections must carry the whole of D , so that, since the distance z is constant between two successive sections, it follows that

$$b\tau_0 = \frac{dD}{dl} = \frac{Q}{z}.$$

The difference which exists between the actual value of the shearing stress in the neutral layer compared with the assumption made on the basis of Stage II*b*, will only be caused by the difference between the calculated lever arm between the centroids of tension and compression, and the actual distance. From the column giving the value of γ in the table on page 99, it is plain that these values do not differ much in rectangular sections, and an examination of the stress distribution shown in Figs. 92 to 94 proves that the actual distance is somewhat smaller than that computed from the expression $h - \frac{x}{3}$. In consequence, in rectangular sections, the value τ_0 along the neutral layer is slightly greater than that given by computations on the basis of Stage II*b*. In T-beams, when ignoring the effect of the tensile stresses in the concrete of the stem, the resultant Z of the tensile stresses falls nearer the steel stress Z_e , and the arm of the couple between tension and compression in the section will be somewhat larger according to the computations than in reality. It is then to be expected that in T-beams, because of the influence of the slab, the shearing stresses in the stem will actually be more closely given by the approximate formula

$$\tau_0 = \frac{Q}{b_0 \left(h - \frac{d}{2} \right)}.$$

Later, the relation of shear to reinforcement will be taken up. An exact theoretical method, however, is seen to be very difficult of development, in view of the uncertainty of computations based on Stage II*a*, when it is to be considered that the stress distribution shown in Fig. 118 corresponds only approximately with fact.

The adhesive stresses given by the formulas developed above for Stage II*b* are too large when compared with the actual conditions at the appearance of the first tension crack, and for Stages I and II*a*. According to the table on page 99, the value of Z_b increases up to the appearance of the first crack. Consequently, the increase of Z_e , which is directly proportional to the adhesive stress, is slower with increase of external moment than that of D , on which the computation of τ_1 is based. In T-beams, where the influence of Z_b is less, the agreement will be better between the computed Z_b and the actual than in rectangular sections.

The shearing force $b_0\tau_0$, found along the neutral axis, also acts in large part along the planes aa' perpendicular to it, which form the connection between the stem and the slab (Fig. 123). The average value of the shearing stress at those points will be

$$\tau = \frac{b_0\tau_0}{2d} \cdot \frac{b-b_0}{b}.$$

In the planes aa' there is no lack of reinforcement, since the slab rods are there present in considerable numbers. Their shearing resistance, however, does not come into play in taking their share of the transfer of the shearing stresses, but rather, their better tensile qualities are active. If it be imagined

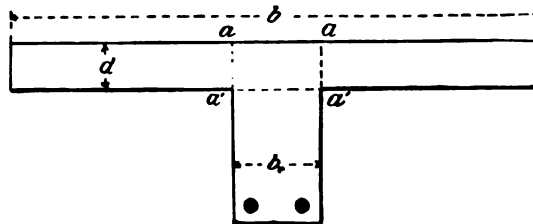

FIG. 123.

that the left flange of the T-beam is cut away along the plane aa' , besides the shearing stresses τ , others perpendicular to them and due to the bending of the slab, will be brought into action on the section. This bending will be resisted by the combination of one flange with the stem and the slab on its opposite side, so that tensile and compressive stresses normal to the plane are brought into play to counteract the bending which would be produced by the shearing stresses τ , and the flange is held in its actual condition, under stress. (Fig. 124.) To these tensile stresses are added the bending tensile ones in the

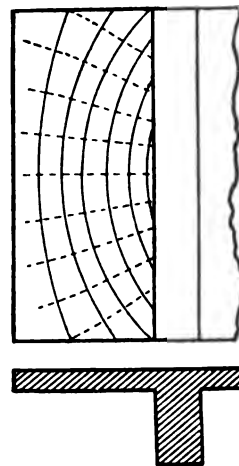
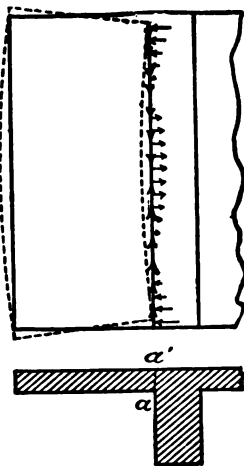

FIG. 124.—Distribution of shearing and normal stresses along the section aa' . FIG. 125.—Probable courses of the stress trajectories in a floor slab acting as a compression member.

slab itself, due to the moment at the support. All the stresses described above produce tension and compression trajectories in the slab, which take somewhat the courses shown in Fig. 125. Thus, the slab reinforcement lies so as to be favorable to the production of a reduction in the principal tensile stresses, which are here less than those of shear, since the accompanying compressive stresses diminish their amount. If the tensile stresses are entirely annulled, the com-

pressive trajectories will become arch lines, which will be held in balance by the tensile strength of the slab reinforcement. If the beams are close together the arches may overlap one another.

If there act on the sides of an infinitesimal parallelepiped (Fig. 126) the pairs of shearing stresses τ , and also the mutually perpendicular normal stresses σ_x and σ_y , then the values of the principal stresses may be computed by the formulas

$$\sigma_I = \frac{1}{2}(\sigma_x + \sigma_y) + \frac{1}{2}\sqrt{(\sigma_x - \sigma_y)^2 + 4\tau^2},$$

$$\sigma_{II} = \frac{1}{2}(\sigma_x + \sigma_y) - \frac{1}{2}\sqrt{(\sigma_x - \sigma_y)^2 + 4\tau^2},$$

and their direction by

$$\tan 2\alpha = -\frac{2\tau}{\sigma_x - \sigma_y}.$$

In the case in hand, since σ_x and σ_y cannot be determined with certainty, an exact theoretical treatment of the question as to the distribution of the stresses in a flat plate is very difficult, and without checking by experiments (which are still rare) would be worthless. Moreover, it is evident that the rounding or sloping of the joint between slabs and stems of beams is of considerable value in the transfer of the shearing stresses at those points. Although in practice this point is often ignored, and the shearing stresses τ along the plane aa' are really excessive in many actual structures (although dangerous consequences have not yet developed), it is invariably best to follow only accepted and safe methods.

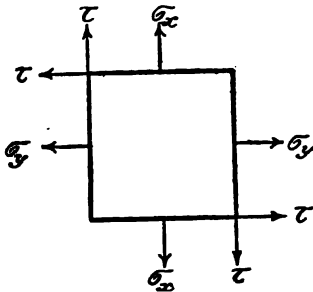

FIG. 126.

The ends of reinforcing rods should always be made with a hook so that sole dependence is not placed on friction or adhesion. For this purpose the shape of the hook is of importance. The form commonly employed, of a simple right-angle bend, is not very effective when surrounded only by a thin concrete slab, as is often the case at the ends of beams. In such cases the ends should rather be given a larger bend of as much as 90° . Considère, in the French section of the International Society for Testing Materials, reported a new form of the end hook, which should be immediately adopted in practice. By bending the end into a half circle, through which a short straight piece may be fastened, the principle of rope friction is employed and a greater frictional resistance is produced on the inner side of the bend, since the hook will be pressed hard against the concrete. Some experiments by Considère led to the result that rods with ends bent into semicircles could be stressed to the elastic limit, while the adhesion of plain rods is between 13.4 and 24.3 kg/cm² (191 and 346 lbs/in²).



FIG. 127.—Form of hook, according to Considère.

When the average unit resistance to sliding developed by these hooks is computed, it is found to be about 77.4 kg/cm² (1095 lbs/in²) of contact between the steel and concrete, or about three times that of plain rods.

These hooks possess the further merit of not depending to any great extent upon the character of the concrete or the care given the work, since a rope-like friction is secured by the large curve of pressure. This pressure naturally should not be too large, since then a crushing of the concrete results. According to Considère, the best results are secured by giving the semicircular bend a diameter about five times that of the rod.

The Action of Stirrups

In the special literature of this subject the opinion is generally advanced that vertical stirrups have the power of reducing the shearing (schub-) stresses in the concrete because of their shearing strength, that they are stressed in shear as well as in tension. In order to compute the distribution of the shearing stress between the concrete and the stirrups, the area of the latter is to be considered

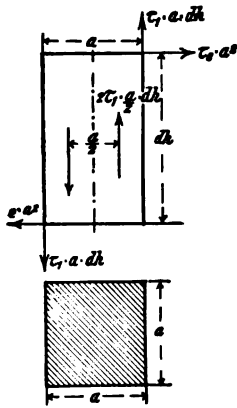

FIG. 128.

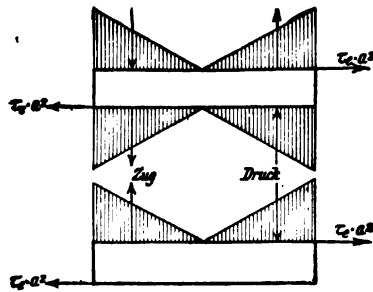

FIG. 129.

as increased *n*-fold. The weakness of this idea is proven by the following points: If a piece of length *dh* be imagined as cut from a stirrup stressed thus in shear (the section of which, for sake of simplicity, is assumed as square) (Fig. 128), then it can be in equilibrium under the action of the shearing stresses $\tau_e a^2$ acting at the ends of the section, only when another couple due to adhesion comes into action. Then

$$\tau_e a^2 \times dh = \tau_1 a \times dh \times a + 2\tau_1 \times \frac{a}{2} \times dh \times \frac{a}{2}$$

must follow, so that $\tau_e = 1.5\tau_1$. That is, the shear in a stirrup cannot exceed one and a half times the adhesive strength. Similarly, for circular stirrups

$$\tau_e = \frac{4}{\pi} \tau_1.$$

The normal stresses upon the sides of the stirrup sections are infinitely small quantities of the second order, and are not considered. Also, normal stresses within the section itself of a stirrup cannot assist in producing equilibrium, because then the bending stresses in two adjacent sections must be opposite in sign (Fig. 129) according to this theory. Round stirrups can thus be stressed in shear to a maximum which is scarcely more than their full adhesive strength, which latter is practically nothing compared with their observed efficiency. An allowable shear for purposes of computation, no larger than the allowable adhesion is worthless. The favorable influence of the stirrups in the following experiments can be explained only through their acting in tension.

CHAPTER X

THEORY OF REINFORCED CONCRETE

EXPERIMENTS CONCERNING THE ACTION OF SHEARING FORCES

The following results were secured by the author near the end of 1906, from experiments on T-beams. The accuracy of the conclusions drawn from them can be checked by means of the now well-known experiments of the Eisenbetonkommission der Jubiläumstiftung der Deutschen Industrie, in the preparation of the outline of the program of which the author assisted as a member.

Experiments by the Author. The experiments were not conducted on T-beams designed according to normal methods, but such dimensions were chosen as would cause failure by exceeding either the value τ_1 of the adhesion, or τ_0 , that of the shear in the rib. The two beams were joined by a continuous slab, so

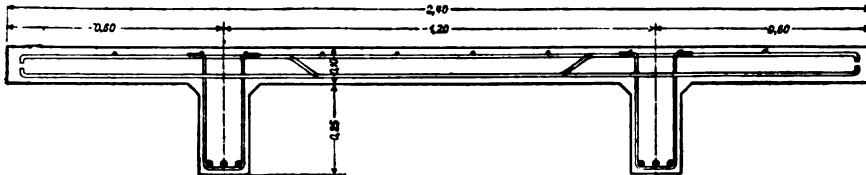

FIG. 130.—Section of test beams.

that the load, which consisted of bars of iron and sacks of sand, could be uniformly applied and not produce torsional stresses as is possible with a single beam and slab. Roofing felt was applied to the ribs over the supports, so as to reduce friction.* The slab was so strongly built that it would carry with safety the breaking loads. (See Fig. 130.)

The small span of 2.70 mm. (8.86 ft.) was adopted, so that the relation between the reactions and the center moments would be out of proportion; in other words, so that failure would take place at the ends before the middle broke. The two beams of each specimen were similarly reinforced. The scheme of loading the twelve specimens involved three groups, in the first of which the load was uniformly distributed; in the second, two symmetrically placed con-

* In the majority of cases the friction at the supports was eliminated by supporting one end from a windlass so that it was free to oscillate.

centrated loads were used; and in the third, the beam was broken by a single center load. The specimens were about three months old, the concrete was mixed in the proportions of one part Heidelberg Portland cement to $4\frac{1}{2}$ parts Rhine sand and gravel, of such size that there were 72 parts of sand of 0 to 7 mm. (0 to $\frac{1}{8}$ in.) grains, and 28 parts of pebbles of 7 to 20 mm. ($\frac{1}{8}$ to $\frac{3}{4}$ in.) diameter. The sides and bottoms of the beams were whitewashed so as better to reveal the cracks. Without such a white coating the first cracks could not be found till a much later period.

The six beams of the first group for uniformly distributed loading, had the same quantity of steel in each beam, although variously distributed.

Beam I. Three straight round bars 18 mm. ($\frac{3}{4}$ in. approx.) in diameter with ends hooked; one-half of the beam without stirrups, and the other half with them.

Beam II. The same as I, except that the ribs were twice as broad.

Beam III. Three straight Thacher rods without hooks; one-half of the beam without stirrups, the other half with them.

Beam IV. The same area of reinforcement as I and II, except that there was one rod of 18 mm. ($\frac{3}{4}$ in. approx.) diameter, and three round rods of 15 mm. ($\frac{9}{16}$ in. approx.) diameter, the latter bent upward at an angle of 45° near the supports, the straight rod hooked at the end, the whole beam without stirrups.

Beam V. The same area of reinforcement in the form of two rods 16 mm. ($\frac{5}{8}$ in.), and two rods 15 mm. ($\frac{9}{16}$ in. approx.) in diameter, the latter bent in the form of a truss from the third points to the tops of the beams over the supports.

Beam VI. Like IV, except with stirrups throughout the whole length of the beam, the lower straight rod without hooks.

The loadings produced the following results in the several beams:

Beam I (Fig. 131). Three straight round rods of 18 mm. ($\frac{3}{4}$ in. approx.) diameter, with hooks at the ends. For a total load of 11.5 t. (12.68 tons) on both beams, the computed stresses according to the "Leitsätze" were $\sigma_s = 1000$ kg/cm² (14223 lbs/in²) on the steel, $\sigma_c = 17.8$ kg/cm² (253 lbs/in²) compression in the concrete, $\tau_0 = 8.4$ kg/cm² (119 lbs/in²) shear over the supports, and $\tau_1 = 6.9$ kg/cm² (98 lbs/in²) adhesion. Thus, with this otherwise permissible load, the shear in the ribs was excessive.

At a load of 7.0 t. (7.7 tons) the first cracks appeared (fine tension ones near the center), corresponding to a computed stress of $\sigma_s = 668$ kg/cm² (9501 lbs/in²). The computation, according to Stage I, with $n = 15$, gave $\sigma_s = 22.7$ kg/cm² (321 lbs/in²). With increasing loads the tension cracks became more numerous and larger, and on the end of the beam with stirrups, some followed the stress trajectories. When the load reached 15 t. (16.5 tons) there appeared on the left side, that is, the end without stirrups, a distinct inclined crack, which, starting from the top gradually extended to the steel. At this load $\sigma_s = 1260$ kg/cm² (17,921 lbs/in²) at the center, and $\tau_0 = 10.5$ (213 lbs/in²), and $\tau_1 = 8.65$ kg/cm² (123 lbs/in²) at the ends of the beams.

The further failure of the beam took place with increased load by an extension of the inclined crack on the left just above the lower reinforcement along it to the support, so that the steel was thrown into compression and the adhesion between it and the concrete of the rib was lost. At a load of 25.7 t. (28.3 tons)

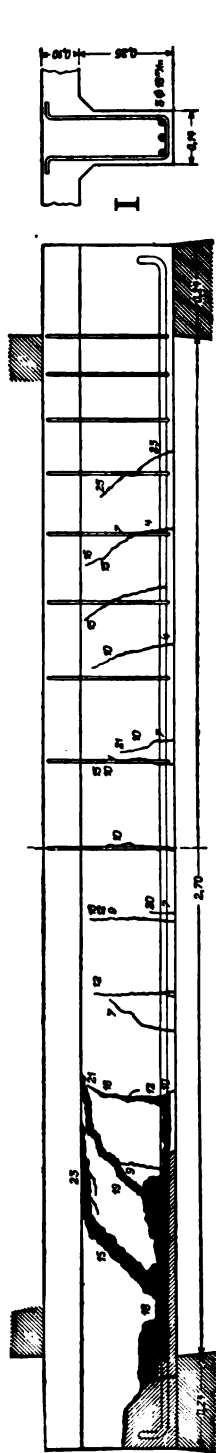

FIG. 131.—Beam I, 3 rods 18 mm. diameter, breaking load, 25.7 t. (27.3 tons).

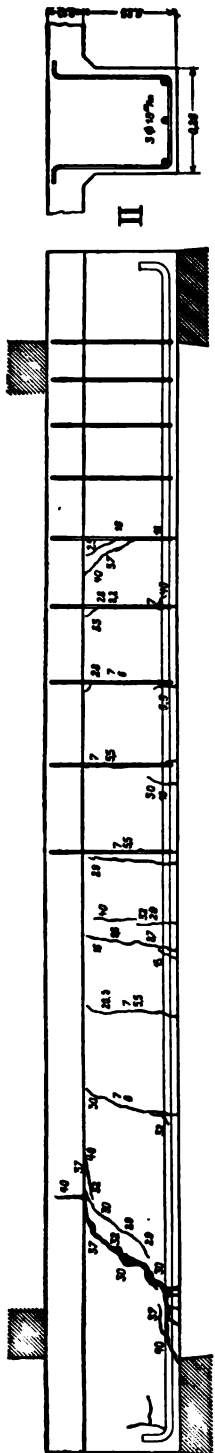

FIG. 132.—Beam II, 3 rods 18 mm. diameter, breaking load 40.0 t. (44 tons).

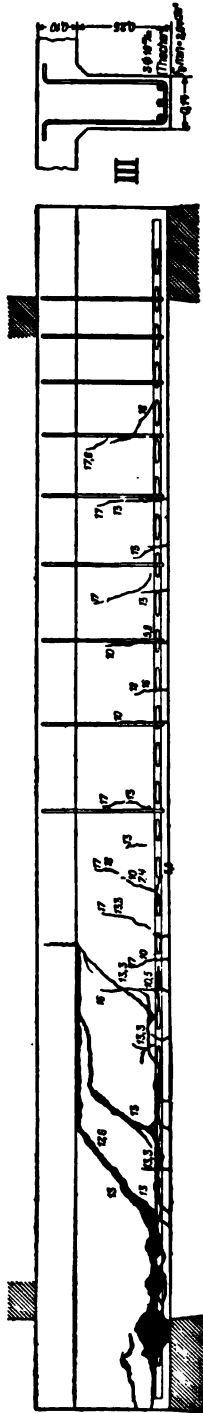

FIG. 133.—Beam III, 3 Thacher rods, breaking load 19.5 t. (21.5 tons).

the horizontal crack had extended entirely to the end of the rod, so that the whole of the force acting on it was carried into the concrete through the hook. It was clearly observed that under this load the horizontal and diagonal cracks enlarged, the hook finally straightened out and, because of the high compression, the concrete cracked, and failure followed suddenly.



FIG. 134.—Beam I, cracks in the end without stirrups at the breaking load.

Under the load of 25.7 t. (28.3 tons) the right end of the beam, which was provided with stirrups, also showed a diagonal crack at a point corresponding almost exactly with the one which caused the break at the other end. The computed stresses at rupture were $\sigma_b = 38.0$ (540 lbs/in²), $\sigma_c = 2060$ (29,300 lbs/in²) in the center, and $\tau_0 = 16.9$ (240 lbs/in²) and $\tau_1 = 13.9$ kg/cm² (198 lbs/in²) at the supports. The last two quantities naturally apply only to the practically



FIG. 135.—Beam I, cracks in the end supplied with stirrups, at the breaking load.

uninjured right end of the beam. Figs. 134 and 135 give characteristic views of the behavior of the two differently reinforced ends.*

Beam II (Fig. 132) differed from the foregoing one only in the double width of the ribs. The first very fine tension crack appeared near the center at a load of 13.7 t. (15.1 tons) and corresponded to a computed steel stress of $\sigma_s = 1200$ kg/cm² (17,067 lbs/in²). (For Stage I with $n = 15$, $\sigma_c = 26.8$ kg/cm² (381

* The cracks were blackened so that they would show in the photograph, and, except when plainly recognizable as failure cracks, were much finer than the lines seen.

lbs/in²). Thus, the first tension crack did not appear at the expected load of 11.5 t. (12.7 tons). This is to be ascribed to the action of the concrete in the tension zone, so that the reduction of stress produced by it in the steel, which influences the formation of tension cracks, will make the suggested method of computation give somewhat higher results for a width of rib of 28 cm. than for one only 14 cm. wide. With increase of load the tension cracks increased in number and at a steel stress of $\sigma_s = 1500 \text{ kg/cm}^2$ (21,335 lbs/in²) were quite conspicuous. At a load of 30 t. (33 tons) two diagonal cracks appeared at the left, one of which extended upward along the under side of the slab and downward along the reinforcement, until finally at a load of 40 t. (44 tons) failure occurred through widening of these cracks, and a pulling out of the reinforcement over the support followed. The computed stresses were

at 30 t (33 tons), $\sigma_c = 2410$ (34,279), $\tau_0 = 10$ (142), $\tau_1 = 16.5 \text{ kg/cm}^2$ (235 lbs/in²),

at 40 t (44 tons), $\sigma_c = 3150$ (44,804), $\tau_0 = 12.9$ (183), $\tau_1 = 21.2 \text{ kg/cm}^2$ (301 lbs/in²).

Beam III (Fig. 133). The reinforcement consisted of three straight Thacher rods without hooks. This kind of reinforcement is theoretically of value in increasing the adhesion, which is here really not in question. If failure had occurred in the first two beams through lack of adhesion, the failure in this case should be different. The Thacher rods were not of constant section, the round part having 2.54 cm² (0.394 in²) and the flattened portion 2.04 cm² (0.312 in²) area.

At a load of 6.8 t. (7.48 tons) the first tension cracks appeared in the neighborhood of the center, corresponding to a computed steel stress of $\sigma_s = 710 \text{ kg/cm}^2$ (10,090 lbs/in²). When the load reached 13 t. (14.3 tons) other later vertical cracks had appeared, and also the first diagonal cracks near the supports. To this load corresponded computed stresses of $\sigma_c = 1370 \text{ kg/cm}^2$ (19,486 lbs/in²) in the center, and $\tau_0 = 9.3$ (131 lbs/in²), $\tau_1 = 7.25 \text{ kg/cm}^2$ (103 lbs/in²) at the supports. At 17.6 t. (19.4 tons) this crack had extended both upward and downward, and also in the end supplied with stirrups a diagonal crack was visible. In Fig. 136 is clearly seen the separation between the steel and its covering, promoted by the spreading effect of the "knots." Failure resulted at a load of 19.5 t. (21.5 tons) with corresponding values of $\sigma_c = 1960 \text{ kg/cm}^2$ (27,877 lbs/in²), $\tau_0 = 13.2$ (198 lbs/in²), and $\tau_1 = 10.3 \text{ kg/cm}^2$ (147 lbs/in²).

At the end containing stirrups, the bursting effect was not seen in the concrete. Just how great was the effect of these stirrups cannot be determined from this experiment.

If the causes and the formation of the cracks in these three beams are examined, it is established that the cracks first became visible where the moment was greatest, and that with increase of load other more distant cracks appeared. On the end supplied with stirrups, the cracks appeared to occur at the sections in which the stirrups were located, since the concrete section was weakened at those points.

In a uniformly loaded beam, when the first tension cracks occur in the middle and penetrate to the reinforcement, then naturally the tensile strength of the concrete is no longer effective and the steel must carry the whole tension in the cracked

sections. The concrete will tend to contract slightly on each side of a crack, while the steel will be stretched more at such a point, and the consequence will be that the two will move in opposite directions until the frictional resistance has decreased the stress in the steel and increased that in the concrete so that both materials are



FIG. 136.—Beam III, with Thacher rods under the breaking load, at the end without stirrups.

stretched an equal amount. The breadth of the crack measured directly along the steel, thus shows the amount of the slip of the concrete over the steel in a certain length.

On the concrete of a rib between two cracks must act the difference ΔZ of the tensions in the steel at the two cracks, this difference being the total frictional resistance between steel and concrete of the corresponding length. Further, the concrete will exert bending stresses on the reinforcing-rod, as shown in Fig. 137,

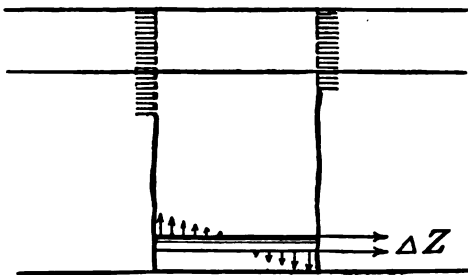

FIG. 137.

which counteract the deformation in the piece of concrete, which would be caused by ΔZ . These stresses must exist because of the somewhat inclined positions of the cracks. One condition favorable to the stresses which act in a piece of concrete between two cracks is that the section which experiences the first crack is stressed to a higher point than the others, the centroid

of pressure of the former lying higher, while the position of the centroid of tension in the reinforcement does not vary with the increasing length of the cracks. Consequently, the decrease ΔZ of the tension precedes that of the bending

moment. This is of particular importance near the centers of uniformly loaded beams in which a sort of arch action takes place.

The cracks near the supports (which were clearly inclined in direction), and which led to final rupture, are to be clearly distinguished from those near the middles of the beams, which commenced low and extended upward with increase of load. In technical literature, the idea has been advanced in the effort to obtain much lower unit adhesive stresses, that these diagonal cracks producing failure are due to an overcoming of the adhesion between the steel and concrete. It is believed, however, that these first three experiments disclose the weakness of that idea. If exceeding the adhesive strength really was the cause of the cracks, approximately equal values of τ_1 should be obtained at the load at which the cracks first appeared in Beams I and II. They differ considerably, however, since the two values are $\tau_1 = 8.65$ and 16.5 kg/cm^2 (123 and 235 lbs/in^2). In Beam III, in which the adhesive strength was not in question, the diagonal crack occurred earlier than in Beam I. It is thus seen that the diagonal cracks, which may lead to failure, start at loads which are proportional to the breadths of the beams, and the conclusion is justified that the tensile strength of the ribs in a diagonal direction was exceeded, and that in this case shearing stresses were primarily involved.

When such a diagonal crack exists, no diagonal tensile stresses can act in the concrete at the faces of such crack and the left hand portion (see Fig. 138) is held

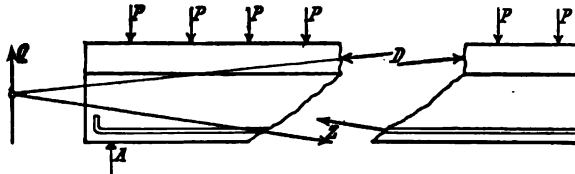

FIG. 138.

in equilibrium by the lateral force Q , the steel tension Z , and the force D , of the arch compression of the concrete. These three forces must intersect at a common point, and consequently D and Z are not parallel, as is shown in the diagram. Since the Z on the left side of the crack acts in a direction inclined downward to the right, it is evident that the turning of the two parts of the beam resulting from the opening of the cracks will cause the reinforcement on the right end of the left hand part of the beam to press downward (see Fig. 139), so that at that point in

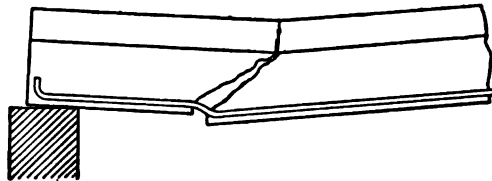

FIG. 139.

the steel a downward force will act which naturally cannot be larger than the tensile strength between the concrete beneath the reinforcement and that in the rib above it. The narrower is the breadth of the concrete around the rods, under

otherwise similar conditions, the sooner must the diagonal crack become horizontal over the reinforcement, and it is evident that both cracks might appear at the same time. In Beam I, 3 t. (3.3 tons) was the increment of the load necessary to extend the crack horizontally; and in Beam II it was 7 t. (7.7 tons); while the total loads at that time were 18 and 37 t. respectively (19.8 and 40.7 tons).

When, then, the connection between the steel and the concrete is destroyed by the downward pressure, the adhesion is no longer effective and the adhesive strength is of no further avail. The tension Z will then become constant along the rod to the hook, and failure must occur when the hook cannot stand the pull. The longer is the horizontal crack along the reinforcement, the more nearly horizontal will Z act, and the more inclined will D become, since both forces must intersect Q , and the consequence is that the slab is lifted away from the rib on the right, this action being promoted by the effect on the bending stress of the adhesion between the steel and the portion of the concrete rib at the right. That is the explanation of the extension of the break horizontally between the slab and the rib, as a continuation of a diagonal crack.

The excess of the breaking load of Beam II over that of I can be explained by the fact that the hooks secured a better hold in the broader rib than in the narrower one.

From these descriptions a conception may be obtained of the action of vertical stirrups. It must be assumed that even in the presence of stirrups, similar stresses exist in the concrete of the rib as when none are present, since the cracks in the vicinity of the support on the side supplied with stirrups were also clearly inclined. The action of the stirrups may then be considered such that in a diagonal section the diagonal tension of the concrete and the major forces Z and D , together with the tensions of the stirrups, hold in equilibrium the external forces on the left side of the section, Fig. 140. First, the diagonal tension in the concrete will be less

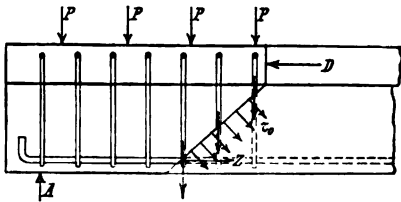

FIG. 140.

and the diagonal cracks will occur later. Further, the downward pressure of the lower reinforcing rods, through exceeding the diagonal tensile strength of the concrete, will be prevented, and also the splitting apart of the slab and the rib. Thus, the stirrups counteract a rupture over a considerable distance near the end of a beam, and in this respect the

increase of the adhesive strength on the end supplied with stirrups can be ascribed to their influence. As to just how far the ability of the stirrups extends in this regard, the previous experiments give no information, and other beams must be tested which are provided with stirrups throughout their full length.

In Beams I and II the location of the diagonal crack which eventually produced failure, may apparently be determined from the position of the section where the upper end of the crack met the under side of the slab, which section experienced with the corresponding loading, the same bending moment as did the center of the beam at the occurrence of the first tension crack. In the first two experiments the upper ends of the cracks were located 40 cm. (15.8 in.) from the supports, and the corresponding bending moments computed in this way are 1.45 and 2.75 m-t., while

the corresponding center moments at the appearance of the first tension cracks were 1.51 and 2.70 m-t.

If the values of τ_0 in these sections are computed at the appearance of the diagonal cracks, there result, for

$$\text{Beam I, } \tau_0 = \frac{10.5 \times 0.05}{1.35} = 7.4 \text{ kg/cm}^2 \text{ (105.3 lbs/in}^2\text{),}$$

$$\text{Beam II, } \tau_0 = \frac{10.0 \times 0.05}{1.35} = 7.0 \text{ kg/cm}^2 \text{ (99.6 lbs/in}^2\text{),}$$

which are in close accord with the directly measured tensile strength of 7.7 kg/cm² (109.5 lbs/in²).

It is thus demonstrated that at the neutral axis the shearing stress develops the tensile strength of the concrete and acts at an angle of 45° with the neutral plane. In consequence of the presence of large tensile stresses in their vicinity, cracks will first tend to occur near the points of support. But the shearing stresses will be predominant at those points, since with the first relative movement between concrete and reinforcement, the normal tensile stresses will be diminished. This explains the rapid extending of the diagonal "shearing" cracks, which quickly reached from their point of origination to the under side of the slabs, thus reaching higher than the earlier tension cracks which formed in the central portions of the beams.

Another question remains: Why are not the diagonal cracks, which arise mainly from shearing stresses, most numerous near the supports where the total force is greatest? To this, two explanations may be advanced. First, in the vicinity of the supports, vertical compressive stresses have to be resisted, arising from the reaction of the support, which diminish the principal stresses. Consequently, the hypothesis of loading of Stage IIb does not apply. Computed according to Stage I, the maximum shearing stress τ at the neutral axis is somewhat larger, but it rapidly diminishes upward and downward, so that a reduction can readily be imagined as taking place in that vicinity.

The favorable influence of the stirrups is obvious in Figs. 131 to 133. Cracks also formed where the stirrups existed, most inclined near the supports, but they did not open as widely as in the other halves. According to Fig. 140, the stirrups which are supposed cut by a plane at an angle of 45°, will prevent a premature failure at the end of the beam, when they are collectively able to resist the total lateral force, so that Z and D may act horizontally. Under this supposition, the stirrups at the end cracks would be stressed in Beam I to $\sigma = 2900 \text{ kg/cm}^2$ (41,248 lbs/in²) and in Beam II to $\sigma = 3900 \text{ kg/cm}^2$ (55,471 lbs/in²). Manifestly, the stirrups lying near the ends resist the downward pressure of the reinforcing rods.

Under the assumptions here made, the stirrups act as the vertical tension members of a truss, while the compression members are diagonals inclined toward the center. (Fig. 141.) Where the cracks rise nearly vertically, the forces are correspondingly small, and at those points of the ribs the stirrups act

also as reinforcement against the bending produced by the sliding resistance of the reinforcing rods.

Beam IV (Fig. 147). The reinforcement consisted of three round rods 15 mm. ($\frac{9}{16}$ in. approximately) in diameter, and one rod 18 mm. ($\frac{3}{4}$ in. approximately) in diameter, thus being just as large as in the preceding specimens. Of these four rods the three of 15 mm. diameter were bent upward at an angle of 45° at the points where the moment diagram allows it. With a load of 11.5 t. (12.7 tons) the computed stresses were: $\sigma_e = 1000 \text{ kg/cm}^2$ (14,223 lbs/in²), $\sigma_b = 18.9 \text{ kg/cm}^2$ (269 lbs/in²), $\tau_0 = 8.5 \text{ kg/cm}^2$ (121 lbs/in²), and for the adhesion the value $\tau_1 = 21.1 \text{ kg/cm}^2$ (300 lbs/in²) when only the single, lower straight rod is considered, with $\tau_1 = 6.0 \text{ kg/cm}^2$ (85 lbs/in²), if all the steel is considered. If the normal tensile stresses in the concrete which produce the diagonal tensile ones in connection with the shearing stresses are imagined as resisted by the bent portions of the lower reinforcing rods, then, according to Fig. 142, all the area

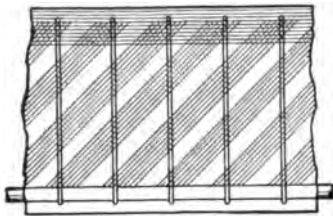

FIG. 141.

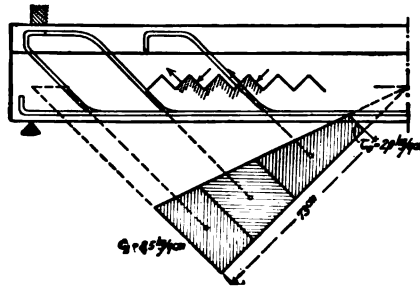

FIG. 142.

elements which slope at an angle of 45° toward the center are in tension and are to be summed, while the opposite ones are in compression, which the concrete easily withstands. The diagonal tension, which is nothing at the center under a uniform load, can be represented by the area of a trapezoid, the smaller base of which corresponds with a tensile stress of $\tau_0 = 2.0$ (28 lbs/in²) for concrete with a factor of safety of four. On this assumption (which may be justified in the case of great extensibility of the concrete), the bending upward of the rods is to be done so that they pass through the centroids of the three equivalent trapezoids making up the large one. In this instance the total tension to be carried by the three rods is

$$Z = \frac{2.0 + 8.5}{2} \times 73 \times 14 = 5366 \text{ kg. (11,805 lbs.),}$$

so that their unit stress is

$$\sigma_e = \frac{5366}{5.3} = \text{approx. } 1000 \text{ kg/cm}^2 \text{ (14,223 lbs/in}^2\text{).}$$

Reinforced concrete beams can also be considered as trusses with single or double web systems (Figs. 143 and 144), wherein the diagonal concrete layers

represent the compression members. The tensile stresses in the bent rods can be checked equally well from the forces acting in the direction of the diagonal, or from the theory that they are the members of a single or more complex intersection system, or from the shearing stress τ_0 .

Since in the foregoing experiments I-III, the cracks near the supports had an inclination of approximately 45° , it is doubtful whether the steel intersecting them was stressed simply in tension. Consequently, the adhesion should be computed differently from the method of p. 146, where only straight rods were



FIG. 143.



FIG. 144.

considered. If the truss arrangement is assumed, a constant stress must exist in the lower rods from the support to the last bend, which stress can be computed from the moment of the section through the corresponding joint of the truss. In a double intersection system, this joint is the point of intersection of the first diagonals; in a single system it is the first top joint. Both fall close to the support, so that the moment may practically be derived from the reaction at that point. If this is represented by Q , and ignoring for the sake of simplicity all load between the support and the first joint, then, on the assumption of diagonals at an angle of 45° , the tension Z in the first lower chord

of a double intersection system is $Z = \frac{Q \frac{x}{2}}{z} = \frac{Q}{2}$;

of a single system is $Z = \frac{Qx}{z} = Q$.

This tension must be transferred to the concrete up to the next point of bend, by the end hook and the adhesion. A properly constructed J-formed hook

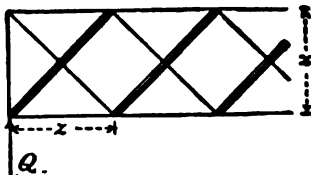

FIG. 145.

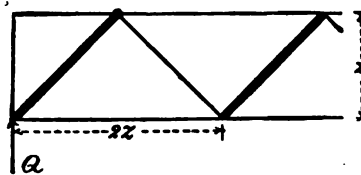

FIG. 146.

would fully and safely transfer the stress; but if it is desired to compute the adhesive stress on the basis of no hook action, then, if the adhesion be considered as uniformly distributed over the first panel length of the rods, if U is the circumference of the straight rods

in a double intersection system, $\tau_1 = \frac{Q}{2zxU}$;

in a single system, $\tau_1 = \frac{Q}{zxU}$,

a value only half that found on the assumption of straight rods only. These formulas apply only when the diagonal tension ($=\tau_0$) is all carried by the bent reinforcing rods, and the other method is to be employed when the value for τ_1 will cause sliding, as determined by the experiments on beams of corresponding construction. So far as the foregoing experiments allow of a decision, the values of the adhesion found by the formulas correspond very well with the figures for direct sliding resistance.

The action of Beam IV under load will next be discussed. With 9 t. (9.9 tons) (see Fig. 147), the first tension crack appeared near the center corresponding to a stress of $\sigma_c=810$ kg/cm² (11,521 lbs/in²). According to Stage I with $n=15$, the tension in the concrete was $\sigma_s=27.1$ kg/cm² (385 lbs/in²). At the same time, at the supports the shearing stress $\tau_0=7.0$ kg/cm² (100 lbs/in²) and the adhesion, according to the formula derived above, was $\tau_1=8.7$ kg/cm² (125 lbs/in²). Other tension cracks appeared at 13.8 (15.2), 14 (15.4), and 18 t. (19.8 tons). The diagonal cracks next the ends appeared at a load of 33 t. (36.3 tons), the one at the left causing failure at 42 t. (46.2 tons). At 33 t. (36.3 tons) it is computed that $\tau_0=21.7$ (309 lbs.) and $\tau_1=26.8$ kg/cm² (385 lbs/in²), and it is seen that since the adhesion would exceed its usual maximum value with increase of load, the nearest bent rods must have carried considerable stress. If the assumption of a truss action is made, the beam corresponds with one with inclined end posts, and the first bent section thus carried a doubly great stress. Consequently, the bent rods exerted a bursting action on the concrete, which would ultimately cause failure. The computed stresses at rupture were $\sigma_b=62$ (882 lbs.), $\sigma_c=3260$ (46,368 lbs.), $\tau_0=27$ (384 lbs.), and $\tau_1=33.5$ kg/cm² (476 lbs/in²), the latter figure evidently having no practical meaning. This experiment proves that it is important *so to arrange the lower rods which run continuously to the ends, that they cannot be pulled out, and, that a good round hook is important at the ends of bent rods.*

In connection with Beam IV will be described:

Beam VI (Fig. 148), in which the main reinforcement was arranged like that of Beam IV, except that the straight rod had no hooks and was carried beyond the end of the concrete, so that the first slip could be observed. Stirrups were supplied throughout the whole length of the beam, and the center one of the bent rods terminated slightly short of lines over the points of support.

The first tension cracks in the middle were visible under a load of 6 t. (6.6 tons), corresponding with a computed stress $\sigma_c=590$ kg/cm² (8392 lbs/in²). The first diagonal cracks occurred at 19 and 20 t. (20.9 and 22 tons), commencing in the tension side exactly like those of Beam IV. At the same time the rod 18 mm. ($\frac{11}{16}$ in.) in diameter which protruded from one end had begun to move inward. Then, $\tau_0=13.1$ (186 lbs.) and $\tau_1=16.3$ kg/cm² (232 lbs/in²). Because of the slipping, the stresses in the bent rods in the vicinity of the supports were augmented.

Failure took place at a load of 37.8 t. (41.6 tons), with computed stresses of $\sigma_b=56$ (797 lbs.), $\sigma_c=2950$ (41,959 lbs.), $\tau_0=24.5$ (348 lbs.), and $\tau_1=30.4$ kg/cm² (432 lbs/in²). The last figure naturally has no meaning. Because of the slipping of the straight rod, the compression at the bends of the outer rods was increased,

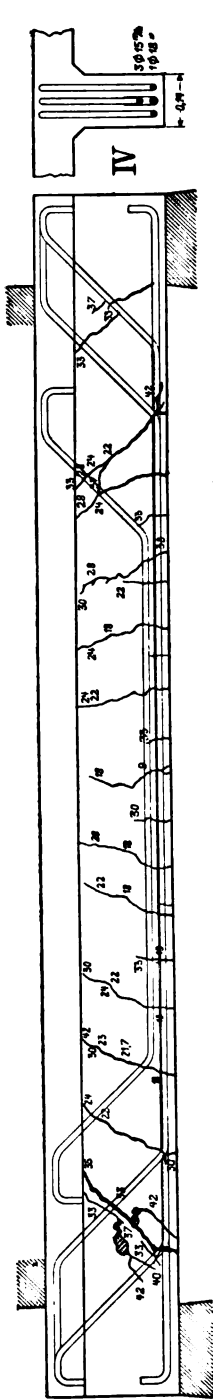

FIG. 147.—Beam IV, breaking load 42 t. (46.2 tons).

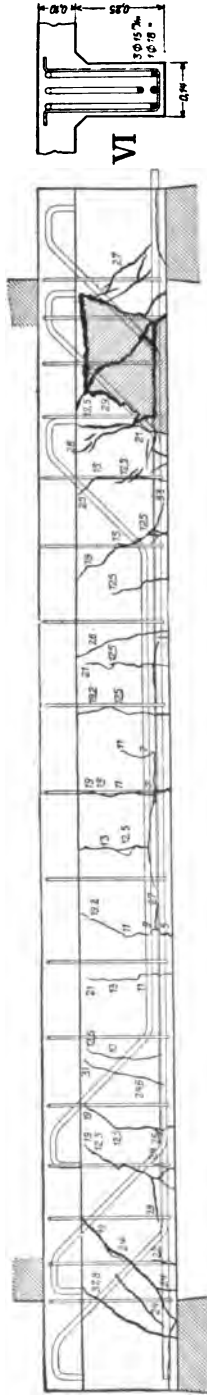

FIG. 148.—Beam VI, breaking load 37.8 t. (41.5 tons).

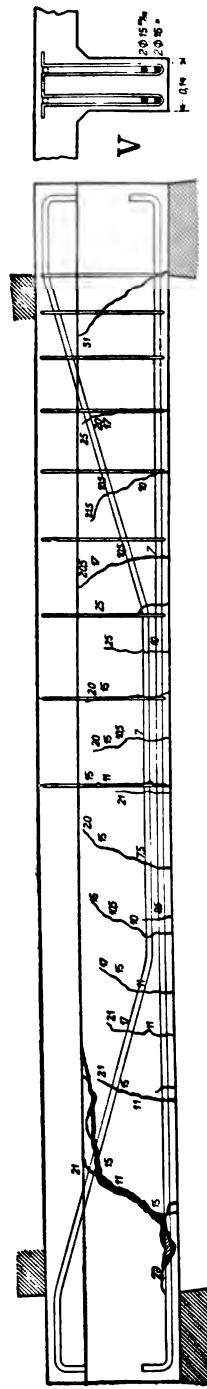

FIG. 149.—Beam V, breaking load 31 t. (34.1 tons).

so that at those points, as in Beam IV, the concrete covering was burst. (See the photograph of Fig. 150.)

By a comparison with IV, it is seen that, with a proper arrangement of the main reinforcing rods, the addition of stirrups has no influence on the shearing stresses, but it is important that the lower rods which are straight should be fully secured against slipping. To this end they should be hooked and be in such numbers as will provide proper safety against slipping. The larger breaking load found in IV is entirely due to the hooks on the ends of the straight rod.

Beam V (Fig. 149). The reinforcement was like that of the Hennebique system, with two straight rods 16 mm. ($\frac{5}{8}$ in.) in diameter and two 15 mm. ($\frac{9}{16}$ in. approximately) in diameter, so bent as to form a suspension system. The last two were bent at the third points, and extended as far as the supports. One-half of the beam had no stirrups, while at the other end were single stirrups closely clasping each rod.



FIG. 150.—Beam VI, under the breaking load.

With a load of 7 t. (7.7 tons) the first tension cracks appeared in both beams, the computed steel stress then being $\sigma_e = 702 \text{ kg/cm}^2$ (9985 lbs/in²). When the load had been increased to 11 t. (12.1 tons), at the end without stirrups a diagonal crack appeared in the upper part of one of the ribs, which produced final failure at 31 t. (34.1 tons). In the other beam the corresponding crack first showed itself at 17 t. (18.7 tons), the difference being due probably to unequal loading. If the shearing stress at the upper ends of the cracks is computed for the average of the two loads, τ_0 is found equal to 7.65 kg/cm^2 (109 lbs/in²), corresponding well with Beams I and II. The development of the failure was exactly like that of I, II, and III, in which the turning of the two parts about their point of contact made the lower reinforcement at the left of the crack exert pressure downward, while the slab was cracked away from the rib above. At the support, the end with stirrups developed an inclined crack at a load of 31 t. (34.1 tons). Under the breaking load, the computed stresses were: $\sigma_b = 48.3$ (687 lbs.), $\sigma_e = 2600$ (36,981 lbs.), $\tau_0 = 21$ (299 lbs.), $\tau_1 = 29.4 \text{ kg/cm}^2$ (418 lbs/in²), the latter computed from the circumference of the two straight rods according to the "Leitsätze."

From a comparison of Beam V with I, II, and III, it follows that with uniform loads, the suspended system of reinforcement does not give any increase of safety against the appearance of diagonal tension cracks, or the final failure produced by them, as compared with straight rods without stirrups, and that stirrups are so much the more necessary. Beam V carried only slightly more than I, less than II, and only three-quarters of IV, so that the superiority of reinforcement along the trajectories is clearly shown. In this connection it should not be forgotten that IV and VI were intentionally so designed that the ultimate adhesive strength of the straight rods would be exceeded.

The first group of experiments, as already stated, gave no indication whether the carrying power would have been increased if the stirrups had been carried the whole length of Beams I, II, III, and V. Furthermore, the question is still open as to whether a decrease of τ_1 by the use of two or three straight rods in IV and VI would have postponed failure to any extent.

The three beams of the second group were designed for two concentrated loads at the third points, and differed from those of the first group only in the arrangement of the reinforcement; which, however, was of the same total area.

Beam VII (Fig. 152) had four rods of 16 mm. ($\frac{5}{8}$ in.) diameter, one of which was carried straight to the supports and was hooked at the ends, while the others were so bent as to cut the layer in which the force was constant, so as to divide it equally. (Fig. 151.) Stirrups were provided throughout the whole length. For a safe load of $2P=9$ t. (9.9 tons), the computed stresses were: $\sigma_e=1010$ (14,365 lbs.), $\tau_0=7.0$ (100 lbs.), and $\tau_1=9.8$ kg/cm² (139 lbs/in²), according to the formula

$$\tau_1 = \frac{Q}{2z U}.$$

The diagonal tension brought onto one of the bent rods was

$$Z = \frac{7.0 \times 14 \times 90}{1.414 \times 3} = 2100 \text{ kg (4620 lbs.)},$$

so that its unit stress was

$$\sigma_e = \frac{2100}{2.01} = 1040 \text{ kg/cm}^2 (14,792 \text{ lbs/in}^2).$$

The first tension cracks were seen in both beams under a load of 7.5 t. (8.3 tons) and were uniformly distributed over the central portion having a constant bending moment. In this condition the stress $\sigma_e=862$ kg/cm² (12,261 lbs/in²), while the tension in the concrete according to Stage I, with $n=15$, was computed at $\sigma_s=29.2$ kg/cm² (415 lbs/in²). With increase of load the tension cracks extended upward, and near the supports other cracks appeared, corresponding with the

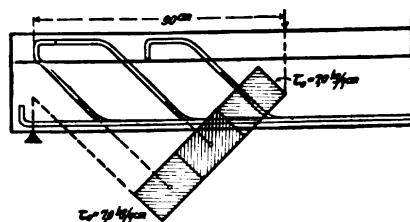

FIG. 151.

diagonal tensile stresses observed in connection with straight and bent reinforcement. The final load was slightly eccentric, so that failure occurred on the right at 34 t. (37.4 tons). On the assumption of a concentrated load of that amount, the computed stresses are thus somewhat too small:

$$\sigma_b = 65 \text{ (925 lbs.)}, \quad \sigma_c = 3420 \text{ (48,643 lbs.)}, \quad \tau_0 = 22.4 \text{ (319 lbs.)}, \\ \tau_1 = 31.5 \text{ kg/cm}^2 \text{ (448 lbs/in}^2\text{)}.$$

No loosening of the ends of the straight rods was observable.

Beam VIII (Fig. 153). The reinforcement consisted of four rods 16 mm. ($\frac{5}{8}$ in.) in diameter, and was arranged like a suspension system, in which half the rods were bent directly from the third points to points over the supports. The width of the rib was only 10 cm. (3.9 in.), and stirrups were used for only one-half the length of the beam.

It is a widely held opinion, that in this arrangement of reinforcement, introduced by Hennebique, a part of the load is carried by the bent bars to the supports and that thus in simple beams with the suspension form of reinforcement, the whole of the reaction does not act near the ends as a shearing force. If this suspension theory of the Hennebique system has any validity, it must be verified in this case, in which the suspension rods have exactly the equilibrium curve for a part of the concentrated loads. The first tension crack became visible at a load of 5 t. (5.5 tons). To this corresponds a stress of $\sigma_c = 648 \text{ kg/cm}^2$ (9217 lbs/in²). Other cracks, distributed over the middle third, followed soon after. At 9.8 t. (10.8 tons) a nearly horizontal crack appeared above the bent rods at the left. At this point τ_0 is computed as 10.7 kg/cm^2 (152 lbs/in²), and taking into account the weight of the beam which slightly increases the lateral forces at the crack, $\tau_1 = 9.7 \text{ kg/cm}^2$ (138 lbs/in²). According to the suspension theory, about half of the load was carried directly by the bent rods, so that the other half came upon the plain beam, which then was stressed to $\tau_0 = 4.8 \text{ kg/cm}^2$ (68 lbs/in²). This does not explain the horizontal crack, however. At 14 t. (15.4 tons), the crack extended downward in an inclined direction, for which load $\tau_0 = 14.2$ (202 lbs/in²). It is to be noted that since the horizontal crack started at 9.8 t. (10.8 tons), the suspension system actually carried about half of the load, so that the τ_0 of the plain beam amounted to approximately 7.1 kg/cm^2 (101 lbs/in²).

Failure resulted from a widening of the diagonal cracks and downward pressure of the reinforcement near the supports, at 23.4 t. (25.7 tons), for which are computed: $\sigma_b = 47.6$ (677), $\sigma_c = 2450$ (34,847), $\tau_0 = 22.8 \text{ kg/cm}^2$ (324 lbs/in²); the adhesive stress τ_1 being as large as τ_0 if it is computed for a beam with only two straight rods. The hooks, which had to carry the whole of the tension, burst the concrete at failure. (See Fig. 155.)

Beam IX (Fig. 154) had the same reinforcement as VIII, but was 14 cm. (5.5 in.) wide.

The first tension crack occurred at 5.9 t. (6.5 tons), with a corresponding stress of $\sigma_c = 735 \text{ kg/cm}^2$ (10,454 lbs/in²). At 14.5 t. (16.0 tons) cracks appeared on the beams, which indicated a looseness of the suspension rods; for this load $\tau_0 = 9.9 \text{ kg/cm}^2$ (141 lbs/in²), not quite so large as for Beam VIII. With 24.5 t. (27.0 tons) in the rear beam the diagonal crack extended toward the support.

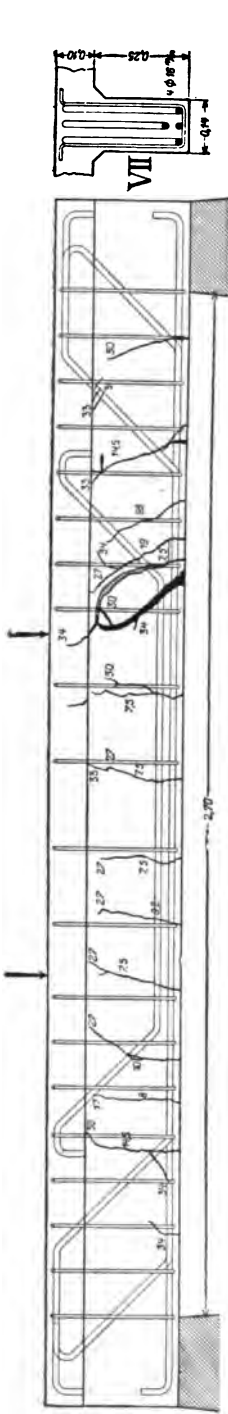

FIG. 152.—Beam VII, breaking load 34 t. (37.4 tons).

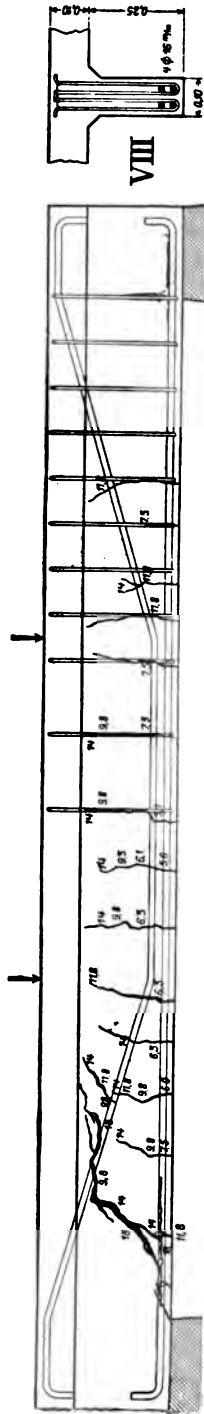

FIG. 153.—Beam VIII, breaking load 23.4 t. (25.7 tons).

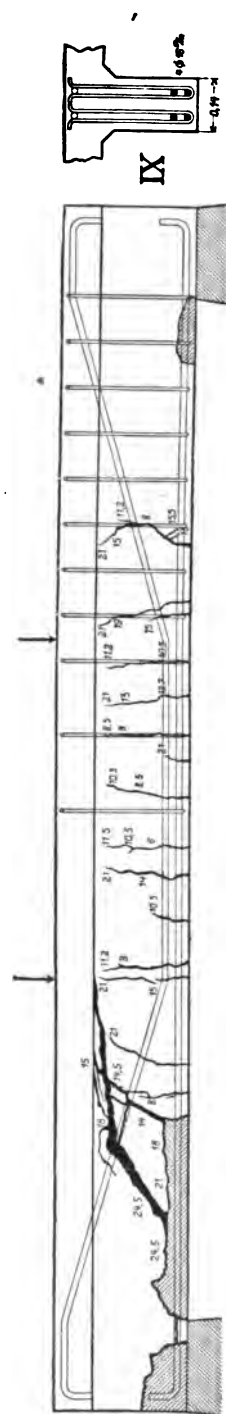

FIG. 154.—Beam IX, breaking load, 25.6 t. (28.2 tons).

Again assuming that the suspension system carried half the load, then for the plain beam $\tau_0 = 8.7 \text{ kg/cm}^2$ (124 lbs/in²), which is practically equal to the tensile strength of concrete. At failure, which took place at 25.6 t. (28.2 tons), in a manner similar to that of Beam VIII, the computed stresses were: $\sigma_b = 52.2$ (742 lbs.), $\sigma_e = 2690$ (38,261 lbs.), $\tau_0 = 17.7$ (252 lbs.), $\tau_1 = 24.8 \text{ kg/cm}^2$ (353 lbs/in²), except that with the suspension theory the last two stresses would be only half as large. The stirrups, supplied on one end, through their tensile strength, hindered the formation of diagonal cracks, and showed themselves essential and indispensable elements in the Hennebique system. The limit of their effect is, however, not disclosed by these experiments. According to the method here given of computing the stresses in the stirrups, they should in this case have been stressed to 1700 kg/cm^2 (24,180 lbs/in²) at the cracking of the concrete. In any case, from the results of the second group of experiments can be deduced the facts that the bending of the reinforcement according to the theory concern-



FIG. 155.—Beam VIII, under the breaking load.

ing the diagonal tensile stress τ_0 is much more effective than according to the suspension theory, in this case the ultimate loads being in the proportion of 34:23.4:25.6. The reinforcement of Beams VIII and IX demands stirrups, and it should be established through special experiments how much better they act than a reinforcement of simply straight rods and a similar arrangement of stirrups.

The third group of specimens was designed for a concentrated load at the center of the beam. Since the same amount of reinforcement was used as in the second group, it is clear that the action of the external force would be counterbalanced by the resisting moment of the center section. In fact, the failure of Beams X to XII took place through exceeding the tensile strength of the reinforcement.

Beam X (Fig. 157). This beam was reinforced according to the trajectory system, with four rods of 16 mm. ($\frac{5}{8}$ in.) diameter, of which three were bent and

one was carried straight through to the supports; one-half of the beam was without, and the other half was supplied with stirrups.

For the first tension crack, which had extended well upward at a load of 7.5 t. (8.3 tons), the computed stresses were $\sigma_e = 1240$ (17,637 lbs.), $\tau_0 = 6.1$ (87 lbs.); and the adhesion, according to the formula

$$\tau_1 = \frac{Q}{2zU},$$

was $\tau_1 = 8.5$ kg/cm² (121 lbs/in²). With increase of load, a large number of tension cracks appeared, without disclosing any substantial difference between the two halves of the beam. Failure took place at 27 t. (29.7 tons) through opening of the center cracks and crushing of the concrete at the upper side of the slab. (See



FIG. 156.—Beam IX, No. 2 rib, under the breaking load.

Fig. 160.) The computed stresses were: $\sigma_b = 77.5$ (1102 lbs.), $\sigma_e = 4050$ (57,605 lbs.), $\tau_0 = 18.1$ (257 lbs.), $\tau_1 = 25.4$ kg/cm² (361 lbs/in²).

In this case the computation of σ_e is worthless since the pressure zone which theoretically should be 7 cm. (2.75 in.) high, was reduced to about 2 cm. (0.79 in.) by the extending of the cracks upward to such a considerable extent because of the great stretch of the steel. If a new arm of 30.2 cm. (11.9 in.) for the couple between tension and compression be used to compute the stresses, with $Z = D = 31,300$ kg. (68,860 lbs.),

$$\sigma_e = \frac{31,300}{8.4} = 3880 \text{ kg/cm}^2 \text{ (55,187 lbs/in}^2\text{),}$$

$$\sigma_b = \frac{2 \times 31,300}{120.2} = 262 \text{ kg/cm}^2 \text{ (3727 lbs/in}^2\text{).}$$

The strength of compression cubes averaged 182 kg/cm² (2589 lbs/in²).

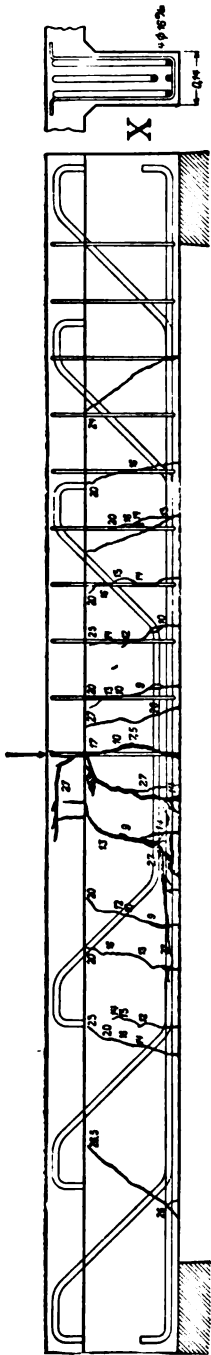

FIG. 157.—Beam X, breaking load 27 t. (29.2 tons).

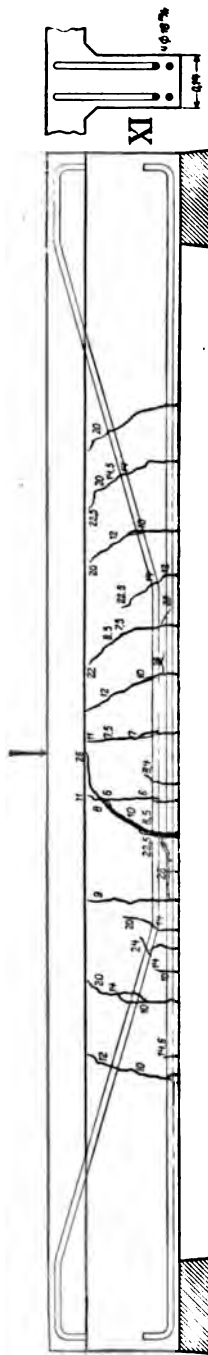

FIG. 158.—Beam XI, breaking load 26 t. (28.6 tons).

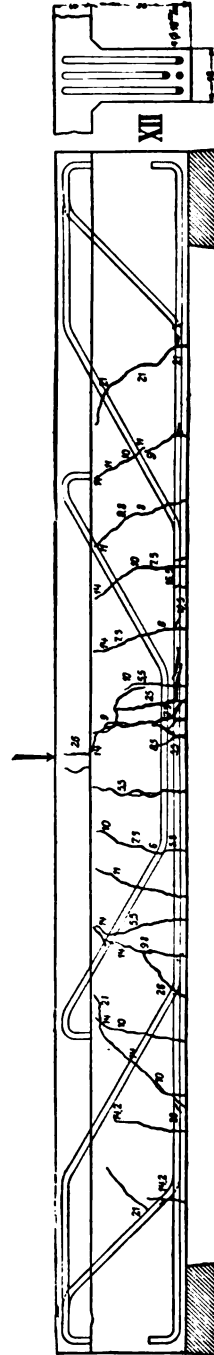

FIG. 159.—Beam XII, breaking load 26 t. (28.6 tons).

Beam XI (Fig. 158) contained reinforcement in the form of a suspension system with no stirrups whatever. At 6 t. (6.6 tons) the first very fine tension cracks became visible, extending well upward in the center, corresponding with stresses of $\sigma_e = 1045$ (14,863 lbs.), $\tau_0 = 5.3$ (75.4 lbs.), $\tau_1 = 7.42$ kg/cm² (105.5 lbs/in²). The remainder of the phenomena were exactly like those of X. Failure occurred in the same manner at 26 t. (28.6 tons), while onward from 22.5 t. (24.8 tons), the center cracks widened rapidly. At failure, $\sigma_e = 4000$ (56,894 lbs.), $\sigma_b = 83$ (1181 lbs.), $\tau_0 = 17.9$ (255 lbs.), $\tau_1 = 25.1$ kg/cm² (357 lbs/in²). Here also σ_b is to be corrected, as in the last specimen, so that 3800 kg/cm² (54,049 lbs/in²) steel stress is obtained.

Beams XII (Fig. 159). The reinforcement consisted of four rods 16 mm. ($\frac{5}{8}$ in.) in diameter, of which one was bent up at an angle of 45°, the two middle



FIG. 160.—Beam X, under the breaking load.

ones at an angle of 30°, while one rod was carried straight through to the supports. The action under load was exactly like that of X. The first tension crack occurred at 5.5 t. (6.1 tons), corresponding to $\sigma_e = 940$ kg/cm² (13,370 lbs/in²). At 26 t. (28.6 tons) the ultimate carrying capacity was exceeded, at computed stresses of $\sigma_b = 74.6$ (1061 lbs.), $\sigma_e = 3900$ (55,471 lbs.), $\tau_0 = 17.5$ (249 lbs.), $\tau_1 = 24.5$ kg/cm² (348 lbs/in²). With the actual lever arm of 30.2 cm. (12.6 in.) there is given

$$Z = D = 30,100 \text{ and } \sigma_e = \frac{30,100}{8.04} = 3740 \text{ kg/cm}^2 \text{ (53,195 lbs/in}^2\text{)}.$$

The beams of the last group thus gave no indication concerning the action of the shearing forces, and to solve this question experiments must be made with heavier reinforcement. The stresses in the reinforcement at failure considerably exceeded the elastic limit of the steel. Other experiments should be performed with regard to this point on beams with rather wide slabs, so that failure

TABLE XXXI

The figures in heavy type are those causing failure.

| Beam Number. | First Crack. | | | | | | Commencement of Diagonal Crack which led to Final Failure. | | | | | | | | | |
|--------------|--------------|------|--------------------|---------------------|--------------------|---------------------|--|-------|--------------------|---------------------|--------------------|---------------------|--------------------|---------------------|------------------------|---------------------|
| | Load Q in | | σ_c | | σ_s | | Load Q in | | σ_c | | τ_1 | | τ_0 | | | |
| | t | tons | kg/cm ² | lbs/in ² | kg/cm ² | lbs/in ² | t | tons | kg/cm ² | lbs/in ² | kg/cm ² | lbs/in ² | At Supports. | | At Upper End of Crack. | |
| | | | | | | | | | | | | | kg/cm ² | lbs/in ² | kg/cm ² | lbs/in ² |
| I | 7.0 | 7.7 | 668 | 9501 | 22.7 | 323 | 15 | 16.5 | 1260 | 17922 | 8.65 | 123 | 10.5 | 149 | 7.4 | 105.3 |
| II | 13.7 | 15.1 | 1200 | 17068 | 26.8 | 381 | 30 | 33.0 | 2410 | 34278 | 16.5 | 235 | 10.0 | 142 | 7.0 | 99.6 |
| III | 5.8 | 6.4 | 710 | 10098 | 19.8 | 282 | 13 | 14.3 | 1370 | 19486 | 7.25 | 103 | 9.3 | 132 | 6.0 | 85.3 |
| IV | 9.0 | 9.9 | 810 | 11521 | 27.1 | 385 | 33 | 36.3 | 2570 | 36554 | 26.8 | 385 | 21.7 | 309 | | |
| V | 7.0 | 7.7 | 702 | 9985 | 22.2 | 316 | 14 | 15.4 | 1260 | 17922 | 14.4 | 205 | 10.3 | 147 | 7.6 | 108.1 |
| VI | 6.0 | 6.6 | 590 | 8392 | 20.1 | 286 | 19 | 20.9 | | | 16.3 | 232 | 13.1 | 186 | | |
| VII | 7.5 | 8.3 | 862 | 12261 | 29.2 | 415 | | | | | | | | | | |
| VIII | 5.1 | 5.6 | 648 | 9217 | 25.1 | 357 | 9.8 | 10.8 | 1115 | 15859 | 10.7 | 152 | 10.7 | 152 | 9.7 | 138.0 |
| IX | 5.9 | 6.5 | 735 | 10454 | 24.2 | 344 | 14.5 | 16.0 | 1580 | 22473 | 15.0 | 213 | 9.9 | 141 | 9.0 | 128.0 |
| X | 7.5 | 8.3 | 1240 | 17637 | 41.0 | 583 | | | | | | | | | | |
| XI | 6.0 | 6.6 | 1045 | 14863 | 33.9 | 482 | | | | | | | | | | |
| XII | 5.5 | 6.1 | 940 | 13370 | 31.6 | 449 | | | | | | | | | | |

| Beam Number. | Breaking Stage. | | | | | | | | | | | |
|--------------|-----------------|------|--------------------|---------------------|--------------------|---------------------|--------------------|---------------------|--------------------|---------------------|--|---------------------|
| | Load Q in | | σ_b | | σ_c | | τ_1 | | τ_0 | | Shearing Stress τ at the Connection Between the Slab and the Rib. | |
| | t | tons | kg/cm ² | lbs/in ² | kg/cm ² | lbs/in ² | kg/cm ² | lbs/in ² | kg/cm ² | lbs/in ² | kg/cm ² | lbs/in ² |
| I | 25.7 | 28.3 | 38.0 | 540 | 2060 | 29300 | 13.9 | 208 | 16.9 | 240 | 10.4 | 148 |
| II | 40.0 | 44.0 | 58.0 | 825 | 3150 | 44803 | 21.2 | 302 | 12.9 | 183 | 13.9 | 208 |
| III | 19.5 | 21.5 | 28.0 | 398 | 1960 | 27877 | 10.3 | 147 | 13.2 | 198 | 8.1 | 115 |
| VI | 42.0 | 46.2 | 62.0 | 882 | 3260 | 46368 | (33.5) | 476 | 27.0 | 384 | 16.7 | 238 |
| V | 31.0 | 34.1 | 48.3 | 687 | 2600 | 36981 | 29.4 | 418 | 21.0 | 299 | 13.0 | 185 |
| VI | 37.8 | 41.6 | 56.0 | 797 | 2950 | 41959 | 30.4 | 432 | 24.5 | 348 | 15.2 | 216 |
| VII | 34.0 | 37.4 | 65.0 | 925 | 3420 | 48043 | 31.5 | 448 | 22.4 | 319 | 13.8 | 196 |
| VIII | 23.4 | 25.7 | 47.6 | 677 | 2450 | 34847 | 22.8 | 324 | 22.8 | 324 | 14.7 | 209 |
| IX | 25.6 | 28.2 | 52.2 | 742 | 2690 | 38261 | 24.8 | 353 | 17.7 | 252 | 11.0 | 156 |
| X | 27.0 | 29.7 | (77.5) | 1102 | 4050 | 57605 | | | | | | |
| | | | | | 3880 | 55187 | 25.4 | 361 | 18.1 | 257 | 11.2 | 159 |
| XI | 26.0 | 28.6 | (83.0) | 1181 | 4000 | 56894 | | | | | | |
| | | | | | 3800 | 54049 | 25.1 | 357 | 17.9 | 255 | 11.1 | 158 |
| XII | 26.0 | 28.6 | (74.6) | 1061 | 3900 | 55471 | | | | | | |
| | | | | | 3740 | 53195 | 24.5 | 348 | 17.5 | 249 | 10.8 | 154 |

of the concrete would occur later, in spite of the high pressure in the top concrete layer.

For sake of clearness, the results of these twelve experiments are reproduced in Table XXXI, where are also given the values of the stresses σ_z in the concrete at the first crack, based on Stage I with $n=15$, and the shearing stresses in the plane connecting the stem and the slab, when failure took place.

CHAPTER XI

THEORY OF REINFORCED CONCRETE

STUTTGART EXPERIMENTS CONCERNING SHEAR,
CONTINUOUS MEMBERS, ETC.*

THESE experiments carried out for the Eisenbetonkommission der Jubiläumstiftung der Deutschen Industrie, were performed on rectangular and T-beams and should give information concerning the value of τ_1 during flexure. In the execution of the programme of tests it must be stated that it was intended that failure of a specimen was not to take place in any other manner until the sliding resistance of the reinforcement had been exceeded.

The rectangular beams 2.16 m. (7.1 ft.) long, were tested on a clear span of 2 m. (6.56 ft.) by two symmetrical loads 1 m. (3.28 ft.) apart. The straight unhooked rods were left visible at the ends of the beams to that the smallest movement could be measured, and over the supports they were almost entirely isolated from the concrete by small cavities left in it. The failure resulted in all cases by overcoming the frictional resistance, the computed values of which are given in Table XXXII.

TABLE XXXII

| No. | Section. | | Reinforcement, One Rod. | | | Values at Failure Computed According to the "Leitsätze." | | | | Age. |
|-----|----------|-----------|-------------------------|-----|----------------|--|---------------------|--------------------|---------------------|----------|
| | cm. | in. | of Diameter | | With Surface. | τ_0 | | τ_1 | | |
| | | | mm. | in. | | kg/cm ² | lbs/in ² | kg/cm ² | lbs/in ² | |
| 1 | 30/30 | 11.8/11.8 | 25 | 1 | smoothed | { 2.7 | 38.4 | 10.3 | 146.5 | 50 days* |
| | | | | | | { 3.8 | 54.1 | 14.5 | 206.2 | 6 mos.† |
| 2 | 30/30 | 11.8/11.8 | 25 | 1 | from the rolls | { 4.7 | 66.9 | 17.9 | 254.6 | 50 days‡ |
| | | | | | | { 5.7 | 81.1 | 22.0 | 312.9 | 6 mos.‡ |
| 3 | 20/30 | 7.9/11.8 | 18 | 1½ | Do. | 6.0 | 85.3 | 21.1 | 300.1 | Do.§ |
| 4 | 15/30 | 5.9/11.8 | 22 | 1 | Do. | 8.8 | 125.2 | 19.1 | 271.7 | Do.¶ |
| 5 | 30/30 | 11.8/11.8 | 32 | 1½ | Do. | 6.6 | 93.8 | 19.8 | 281.6 | Do.¶ |

* Only one vertical crack under a load.

† Vertical break.

‡ Break very slightly inclined.

§ Break somewhat inclined in part.

¶ Break clearly inclined in part.

¶ Break almost vertical.

* C. v. Bach. Versuche mit Eisenbetonbalken, Berlin, 1907. Mitteilungen über Forschungsarbeiten, Nos. 45 to 47.

In specimen No. 1, which was fifty days old, the failure resulted at the appearance of the first crack, while in all other cases, the frictional resistance was so great that other cracks appeared with increase of load. In all cases a longitudinal crack formed along the under side of the reinforcement as soon as sliding started, growing out of the inclined direction of the cracks as above described. Between the two loads where the moment was constant, the tension cracks were almost uniformly distributed. The carrying power of this beam ceased with the slip of the rod.

Several beams similar to No. 4 were built with stirrups made of 7 mm. ($\frac{5}{16}$ in. approx.) material, which clasped the reinforcing rod closely and were spaced 8 cm. ($3\frac{1}{8}$ in.) apart between the supports and the loads. The center portion, between the loads, where no lateral forces were active, had no stirrups. The experiments showed that the first tension cracks occurred earlier

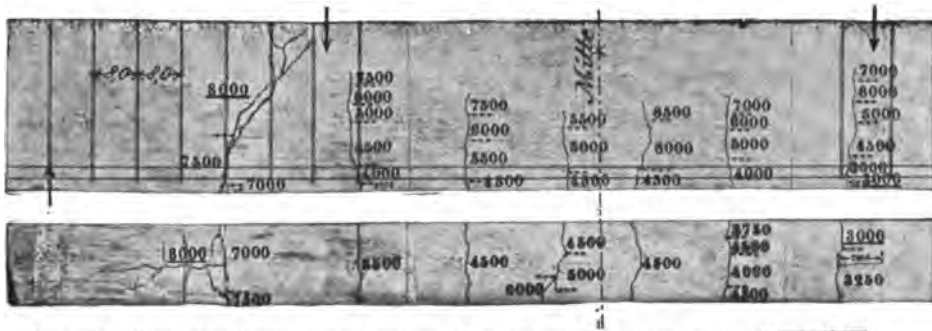

FIG. 161.—Side view, bottom, and section of a rectangular beam with straight reinforcement and with stirrups.

and close to the inner stirrups, which is to be ascribed to the weakening of the concrete section at those points. Moreover, the direction of the cracks was exactly like that of the beams without stirrups. The crack causing failure which extended diagonally upward to the point of application of one load, was, however, more inclined (Fig. 161).

The average value of the computed frictional resistance of the three experiments was

$$\tau_1 = 23.3 \text{ kg/cm}^2 \text{ (331 lbs/in}^2\text{),}$$

while the corresponding beam without stirrups gave only 19.1 kg/cm^2 (272 lbs/in^2). This increase is due to the resistance offered by the stirrups to the downward pressure of the reinforcing rods. On the assumption made previously in connection with diagonal tension cracks, that the stirrups resist the lateral forces over a distance along the neutral axis, equal to the arm of the couple between the centroids of tension and compression, then the tensile stress in the stirrups at the first slip equaled 1680 kg/cm^2 ($23,895 \text{ lbs/in}^2$). The stress of $\tau_1 = 23.3 \text{ kg/cm}^2$ (331 lbs/in^2) is in good accord with the results of direct adhesion experiments. The composition of the concrete was similar, viz., one part Portland cement to four parts Rhine sand and gravel, with 15% of water. The tensile strength of the con-

crete was ascertained to be 12.6 kg/cm^2 (179 lbs/in^2), and hence the inclination of the crack causing failure would be slight, with the very small value of τ_0 .

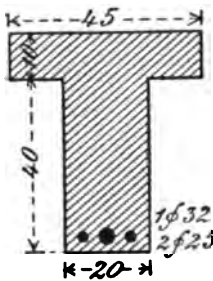
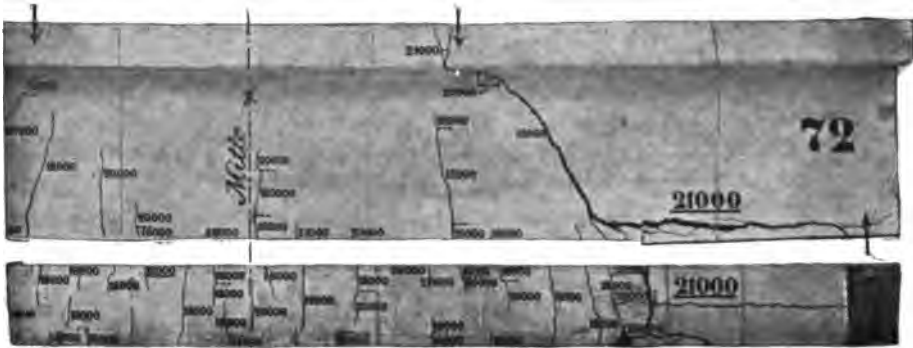

FIG. 162.—Side view, bottom, and cross-section of a beam of T-section with straight reinforcement without hooks and with stirrups.

The beams of T-section had a span of 3 m. (9.8 ft.), and were tested with two symmetrically placed loads, 1 m. (3.3 ft.) apart. Of the three groups, all of which had only straight main reinforcing rods, two of 24 and one of 32 mm. ($1\frac{5}{8}$ and $1\frac{1}{4}$ in.) diameter, the first had no stirrups, while the second had 7 mm. ($\frac{5}{16}$ in. approx.) stirrups closely clasping the rods, and spaced 9 cm. (3.5 in.) apart throughout the spaces with constant shear, and the third had thirty by

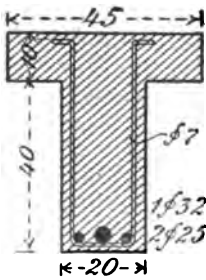
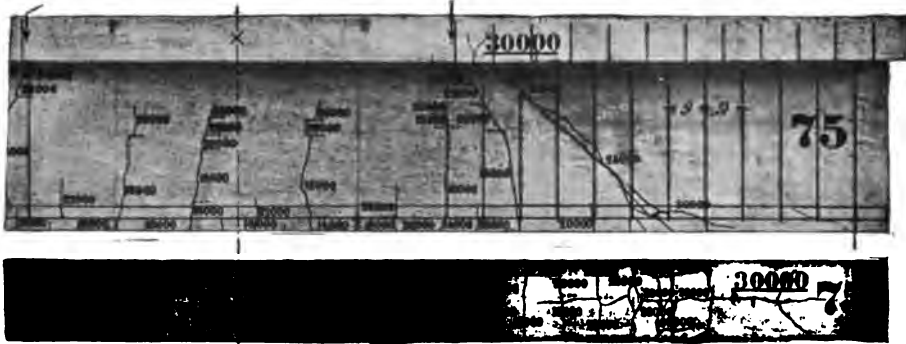

FIG. 163.—Side view, bottom, and section of a beam of T-section with straight reinforcement and with stirrups.

2 mm. ($1\frac{3}{16}$ by $\frac{5}{8}$ in.) flat iron individual (Hennebique) stirrups on each rod, stirrups 14 cm. (5.5 in.) apart.

In the group without stirrups, the first cracks appeared at loads of 14 and 16 t. (15.4 and 17.6 tons), while at 18 t. (19.8 tons) a diagonal crack started, running toward a load point, which extended very well up the side and soon surpassed the center tension cracks (Fig. 162). The further course and final appearance at failure were similar to those of Beams I-III of the T-beam experiments

described on pages 152 to 159. At a load of 18 t. (19.8 tons), $\tau_0 = 10.3 \text{ kg/cm}^2$ (147 lbs/in²).

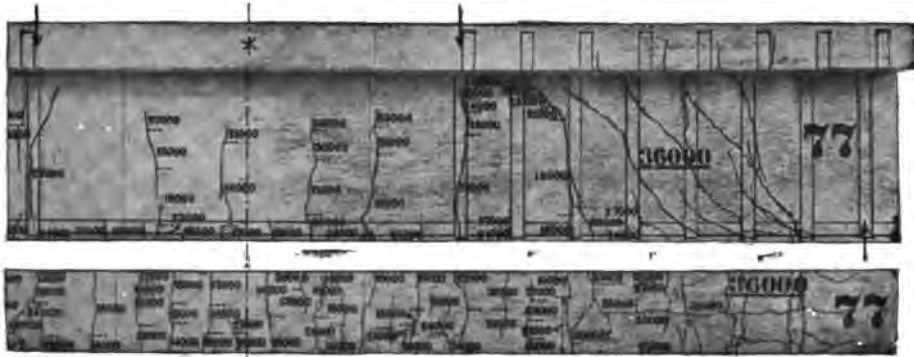

FIG. 164.—Side view, bottom, and cross-section of beams of T-section with straight reinforcing-rods and stirrups.

The second group, with 7 mm. ($\frac{5}{16}$ in. approx.) stirrups, developed cracks like those illustrated in Fig. 163, the diagonal, almost straight ones at an angle of 45° appearing last.

In the beams supplied with Hennebique stirrups (Fig. 164), of the cracks between the load and a support, the lower parts followed the stirrups, while in their upper parts they took an inclined direction toward the load points. At failure, the diagonal

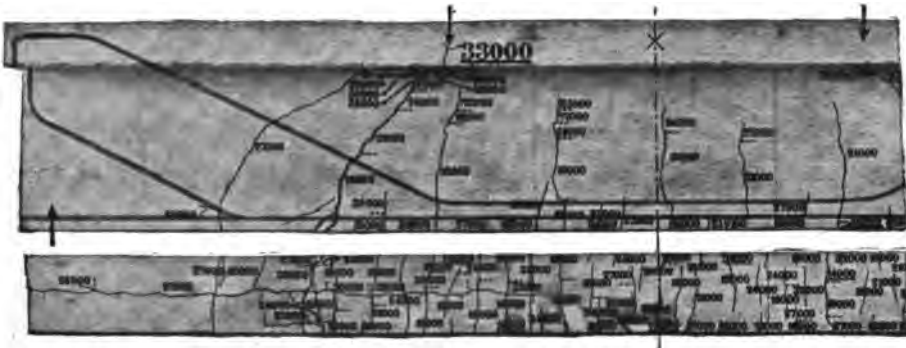
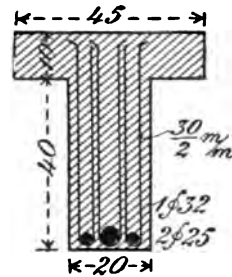
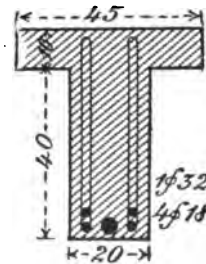

FIG. 165.—Side view, bottom, and cross-section of beams of T-section with one straight and four bent rods without stirrups.

cracks shown in the illustration near the support were present.

Other beams of similar dimensions were tested, the principal reinforcement of which consisted of one round rod 32 mm. ($1\frac{1}{4}$ in.) in diameter, and four bent rods of 18 mm. ($\frac{3}{4}$ in. approx.) diameter. The slope of the latter was somewhat flatter than 45°. Three specimens were without stirrups, while six had 7 mm. ($\frac{5}{16}$ in. approx.) closely clasping stirrups, spaced 9 cm. ($3\frac{1}{2}$ in.) in



the outer thirds. In half of the beams the lower rod was absolutely straight, while in the other half a right angle hook was provided. The directions of the



FIG. 166.—Side view, bottom, and cross-section of beams of T-section with one straight and four bent rods and with stirrups.

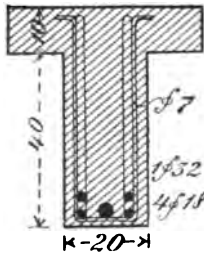

cracks were like those of the beams with only straight rods and with stirrups, as shown in Figs. 165-167.

For extra clearness, the results are collected in Table XXXIV, in which are also included the beams of 2 m. (6.4 ft.) span, without stirrups, with rods bent about 45° (Fig. 168).

Concerning the table, it should be added: That in the beams with straight tension reinforcement, the more stirrups were provided, the later was the occurrence of the

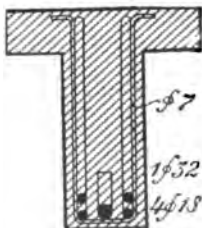
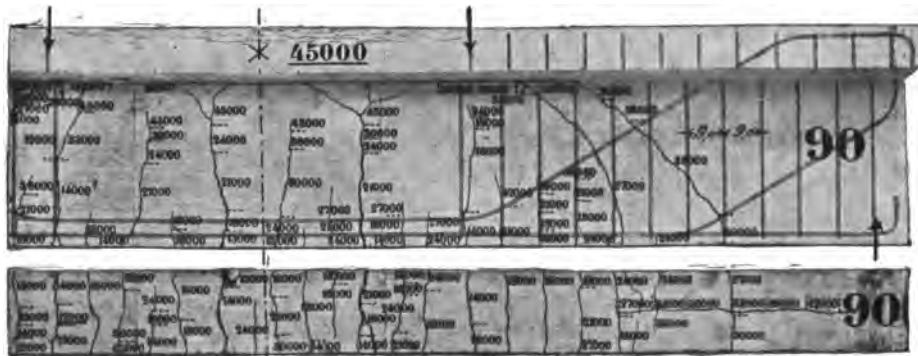
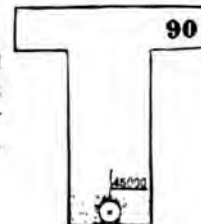

FIG. 167.—Side view, bottom, cross-section, and end view of a beam of T-section with a straight round rod 32 mm. (1 1/4 in. approx.) in diameter with hook, from bent round rods 18 mm. (3/8 in. approx.) in diameter and with stirrups.



first slip and failure. This point is explained by the condition that the tensile strength of the stirrups prevented the downward pressure of the reinforcing rods near the supports after the appearance of diagonal cracks. The more the

TABLE XXXIV

| Fig. No. | Beam. | | | | | | | | | | At First Slip. | | | | | | | | | | At Failure. | | | | | | | | | |
|----------|-------|-------|------------|------------------|----------|------|-----------|--------------------|---------------------|--------------------|---------------------|--------------------|---------------------|--------------------|---------------------|--------------------|----------------------|--------------------|---------------------|--------------------|---------------------|--------------------|---------------------|--|--|--|--|--|--|--|
| | Span. | | Main Rods. | | | | Stirrups. | | P | | σ_b | | σ_e | | τ_0 | | τ_1 by Formula. | | $Q/2sU$. | | Q/sU . | | | | | | | | | |
| | m. | ft. | No. | Shape. | Ends. | t | tons | kg/cm ² | lbs/in ² | kg/cm ² | lbs/in ² | kg/cm ² | lbs/in ² | kg/cm ² | lbs/in ² | kg/cm ² | lbs/in ² | kg/cm ² | lbs/in ² | kg/cm ² | lbs/in ² | kg/cm ² | lbs/in ² | | | | | | | |
| 162 | 3 | 9.8 | | straight | straight | 21.7 | 23.9 | 69.9 | 994 | 1394 | 19827 | 12.4 | 176 | | | | | | | | | 11.1 | 158 | | | | | | | |
| 163 | 3 | 9.8 | | straight | used | 25.0 | 27.5 | 79.3 | 1128 | 1601 | 22772 | 14.2 | 202 | | | | | | | | | 12.8 | 178 | | | | | | | |
| 164 | 3 | 9.8 | | straight | used | 28.7 | 31.6 | 90.9 | 1293 | 1840 | 26171 | 16.3 | 232 | | | | | | | | | 14.7 | 209 | | | | | | | |
| 165 | | | { 1 4 | straight bent | | 24.7 | 27.2 | 79.6 | 1132 | 1534 | 21819 | 14.2 | 202 | | | | | | | | | 28.7 | 410 | | | | | | | |
| 166 | | | { 1 4 | straight bent | used | 30.0 | 33.0 | 98.7 | 1404 | 1910 | 27116 | 17.4 | 247 | | | | | | | | | 35.0 | 498 | | | | | | | |
| 167 | | | { 1 4 | straight bent | hooked | 33.0 | 36.3 | 108.9 | 1649 | 2075 | 29313 | 19.1 | 272 | | | | | | | | | 38.4 | 546 | | | | | | | |
| 168 | 2 | 6.6 | { 1 4 | straight bent | | 32.0 | 35.2 | 52.0 | 740 | 1004 | 14792 | 18.3 | 168 | | | | | | | | | 36.7 | 523 | | | | | | | |

| Fig. No. | At First Slip. | | | | | | | | | | At Failure. | | | | | | | | | |
|----------|------------------------------------|---------------------|-------|-------|--------------------|---------------------|--------------------|---------------------|--------------------|---------------------|--------------------|---------------------|----------------------|---------------------|--------------------|---------------------|--------------------|---------------------|-------|-------|
| | τ_1 Considering all the Rods. | | P | | | | σ_b | | σ_e | | τ_0 | | τ_1 by Formula. | | $Q/2sU$. | | Q/sU . | | | |
| | kg/cm ² | lbs/in ² | t | tons | kg/cm ² | lbs/in ² | kg/cm ² | lbs/in ² | kg/cm ² | lbs/in ² | kg/cm ² | lbs/in ² | kg/cm ² | lbs/in ² | kg/cm ² | lbs/in ² | kg/cm ² | lbs/in ² | | |
| 162 | | | 23.0 | 25.3 | 74.2 | 1055 | 1480 | 21051 | 13.1 | 186 | | | 11.8 | 168 | | | | | | |
| 163 | | | 30.5 | 33.6 | 96.6 | 1374 | 1952 | 27764 | 17.2 | 244 | | | 15.6 | 222 | | | | | | |
| 164 | | | 37.7 | 41.5 | 119.5 | 1700 | 2419 | 34406 | 21.4 | 304 | | | 19.3 | 275 | | | | | | |
| 165 | 8.7 | 124 | 33.3 | 36.6 | 107.6 | 1530 | 2073 | 29485 | 19.2 | 273 | 19.4 | 276 | 38.8 | 552 | 11.8 | 168 | 1950 | 27736 | 2650 | 37692 |
| 166 | 10.6 | 151 | 41.0 | 45.1 | 134.9 | 1919 | 2611 | 37137 | 23.8 | 339 | 23.9 | 340 | 47.9 | 681 | 14.5 | 206 | 2400 | 34134 | 3280 | 46653 |
| 167 | 11.6 | 165 | 46.5 | 51.2 | 154.6 | 2199 | 2958 | 42073 | 27.1 | 385 | 27.3 | 388 | 54.6 | 777 | 16.5 | 235 | 2640 | 37550 | 3730 | 53053 |
| 168 | 11.1 | 158 | | | | | | | | | | | | | | | 1270 | 18064 | | |

NOTE.—The varying diameters of the straight rods cause them to share unequally the shear $b\tau_0$ in proportion to their areas. The adhesion is consequently largest on the thicker rods. For the beams of Figs. 162, 163, and 164 this condition is to be considered.

tension in the stirrups was augmented, the harder did they press the main rods upward against the concrete, and the harder did the latter act diagonally downward from above, in consequence of which a considerable frictional resistance was developed, so that failure took place only after the first slip had occurred.

For similar reasons, in beams supplied with both bent rods and stirrups, a greater frictional resistance was developed than when stirrups were absent. The action of the hooks at the ends of the straight rods resulted in an increase of the load from 41 to 46.5 t. (45.1 to 51.2 tons). In Fig. 167 can be seen the result of the failure of the concrete because of the straightening of the hooks.

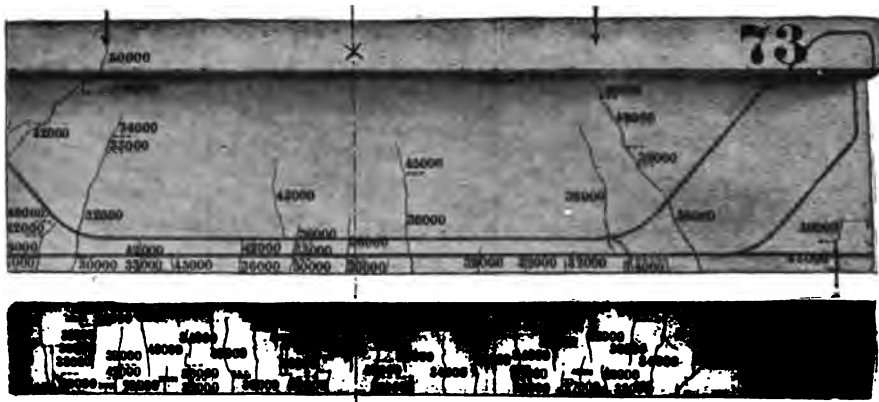

FIG. 168.—Side view and bottom of a T-beam of 2 m. (6.56 ft.) span with one straight round rod 32 mm. ($1\frac{1}{4}$ in. approx.) and bent rods 18 mm. ($\frac{3}{4}$ in. approx.) in diameter without stirrups.

If the tensile stresses are computed for the stirrups of the beams which had only straight rods, on the assumption that at the appearance of the diagonal crack, they must carry the whole shear over a length equal to the distance between the centroids of compression and tension, the values found in Table XXXV are obtained.

TABLE XXXV

| Beam Illustrated in Figure. | Stress in Stirrups | | | |
|--------------------------------|--------------------|---------------------|--------------------|---------------------|
| | at the First Slip. | | at Failure. | |
| | kg/cm ² | lbs/in ² | kg/cm ² | lbs/in ² |
| 163 | 3450 | 49271 | 4200 | 59738 |
| 164 | 1340 | 19059 | 1750 | 24891 |

The beam shown in Fig. 167 had its end so constructed that failure took place inside the loads by compression of the concrete at the top. In the remainder of the beams, with bent rods, it may be supposed that as soon as a slip took place in the straight rods, the nearest bent one was stressed more heavily, so that the breaking crack was formed between the two bent bars. The nearest bent bar then acted as the tension member of the beam. In consequence of the

great stretch of the reinforcement, the zone of compression in the slab would become shallower until the top layer of concrete crushed. (See Fig. 166.)

From a comparison of Figs. 162-167, it is seen that the diagonal cracks produced by any load, extend very high in beams with only straight rods and no stirrups and for which τ_0 as estimated is practically equal to the tensile strength of the concrete. They occur later when stirrups or bent rods, or both combined, are present. The more steel is cut by a crack, the later will it appear.

DEDUCTIONS FROM THE EXPERIMENTS

So far as the relations between the foregoing experiments go, for simply supported T-beams, the following deductions can be drawn:

1. In reinforced concrete beams, near the supports neither a pure vertical shear exists nor one in a horizontal direction, but rather the action of the shearing forces develop inclined cracks in the vicinity of the points of support. At these cracks, the tensile strength of the concrete will be exceeded by the diagonal principal stress, and it depends upon the manner of loading, breadth of span, and arrangement of reinforcement, whether the failure will take place in the center because of high bending moment, or near the supports indirectly through heavy shearing forces. In general, the diagonal cracks follow the directions of the stress trajectories. By employing stirrups and variously arranged bent rods, the direction of the cracks is not materially altered, but the inclined cracks near the supports occur later, showing that this steel diminishes the diagonal tensile stresses in the concrete. The strength of the concrete in pure shear plays no part in producing security against indirect failure of the concrete from shear, and, moreover, the horizontal and vertical shearing stresses produced during the bending of a reinforced concrete beam are to be considered such that the elemental areas affected by them are not perpendicular to the direction of the main tension and compression.

2. In any beam in which a failure would take place at a support because of lateral forces, when only straight rods are employed, the supporting power will be increased through an arrangement of stirrups and bent rods. Their use seems particularly advisable, since without much increase of material a greater load is assured.

It is very important that the straight rods do not slip at the supports, since both series of experiments showed a very favorable action by the hooks at the ends in the increase of ultimate load. In comparison with the usual right angle or blunt hook employed heretofore, the arrangement proposed by Considère, and shown in Fig. 127, is of great value, since it renders unnecessary the computation of the adhesive stress.

From the tests made by the author, it is shown that the best results follow when the bending of rods is so done that they may carry the diagonal tensile stresses equal to τ_0 which act at an angle of 45° , and also provide the necessary amount of steel along the under side to care for the moments. A reinforced concrete beam of constant depth can then be compared to a single or double intersection truss or one of higher order (Figs. 143 and 144), in which tension



and compression members slope toward the middle at an angle of 45° . From the outset, it may be concluded that the double system is better than the single, since then the reinforcement is distributed more uniformly through the concrete rib. A somewhat flatter slope of the bent rods appears of no value, but it may be recommended for constructive reasons in large spans on account of conditions. At the upper ends of the inclined parts of bent rods the force carried by the tension member must be resolved into the force at right angles to it in the compression member, and a force in the direction of the top chord. The latter component acts in the upper part of the bent rod itself, and it must have a straight portion ending with an effective hook, capable of transferring its stress to that of the concrete in the top chord.* Similarly the tension in the

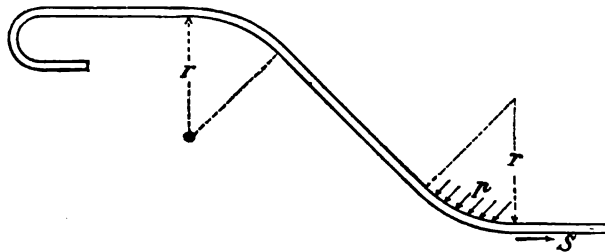

FIG. 169.

inclined part of a bent rod at the lower bend must be resolved in the direction of the compression diagonal acting at that point, and of the lower chord, clearly showing that the simplest and most effective course is to bend upward in a curve of radius r , one of the rods rendered unnecessary by the reduction in the bending moment. However, when this is done the adhesion on the remainder of the reinforcement will be more severely taxed.

As is shown by Beams IV and VI of the author's experiments, it is necessary to keep at a low value the compression of the concrete at the bend of the rod. If the pressure p , acting on a unit area of the projection of the bend be computed, as is customary with rivets, then there is found approximately, if d represents the diameter

$$p d r = S = \sigma_e \pi \frac{d^2}{4},$$

so that

$$r = \frac{\sigma_e \pi d}{4p}.$$

With $\sigma_e = 1000 \text{ kg/cm}^2$ (14,223 lbs/in²) and $p = 60 \text{ kg/cm}^2$ (853 lbs/in²), $r = 13d$ approximately. If the rods are bent cold, it is easier to do so with an even greater radius. It is recommended that the reinforcing rods be bent up, as soon as they become useless because of reduction of the moments near the supports, and be anchored in the zone of compression, as described above; because, according to some earlier experiments of Wayss and Freytag (see second edition of this book), when the lower rods have been provided simply with hooks, cracks occur very early, due to the sudden change of stress.

* Of the imaginary truss.—TRANS.

3. Stirrups also increase the carrying power, since their tensile strength resists a failure at the end of a beam. According to the experiments of the Stuttgart testing laboratory, they increase the adhesion of straight rods in this same manner. However, if the principal reinforcing rods are arranged as above described, then the stirrups have only a subordinate statical function, and can be considered a further item of security, which becomes active when other structural elements fail. Stirrups are also useful through the center portions of beams when the latter are unsymmetrically loaded and shearing stresses are produced at points which are not usually included in statical computations. Then the stirrups must act as vertical tension members, as illustrated in Fig. 141, or if a later stage be considered, as reinforcement of the parts of the concrete rib between cracks. Moreover, an experiment of Schüle (Table VII, No. X, Eidgenössischen Materialprüfungsanstalt, Zurich) with a heavily reinforced, uniformly loaded, T-shaped beam (No. 13), the end of which was reinforced against shearing stresses by proper bent rods, showed that with increase of load the characteristic diagonal cracks which finally produced failure appeared in the central portion which was reinforced against shear neither with stirrups or bent rods, and cut directly through the tension cracks which had formed earlier. When they are present, stirrups thus have a value throughout the middle of a beam similar to the one they possess at the ends.

Evidently it is not wise to confine the stirrups simply to the ribs. At the same time they assure a connection between the rib and the floor slab in cases where splitting apart of the concrete might occur. Further, it is believed that a beam with stirrups throughout its whole length withstands dynamic action better than one without them. The computation of the stirrups can be made on the assumption that the area of stirrups cut by a section taken at an angle of 45° through the rib, carries all the lateral forces existing in that section. In the centers of the beams, where bent rods cannot be arranged, the stirrups must be designed for the whole shear, while near the supports the whole of the shearing stresses can be computed as carried by the bent rods, or a part by the stirrups also.

When it is intended that a given security against failure be provided in all parts of a reinforced concrete beam, it is not proper to consider the distribution of stresses under a safe working load as measuring this security. Then it is the resistance just before failure which is involved. Consequently, the diagonal reinforcement and the stirrups should not be computed in connection with the diagonal tension in the concrete, since they would already be overloaded at the moment of failure. In the central portions of beams the tensile strength of the concrete in a diagonal direction cannot be computed as active, when cracks have already been produced by the normal tensile stresses.

If the tensile strength of the concrete is assumed as 8 kg/cm^2 (114 lbs/in^2), then precaution against shear at the supports is unnecessary if τ_0 does not exceed 2 kg/cm^2 (28 lbs/in^2). This condition usually exists in rectangular sections, like slabs, but nevertheless it is usual to bend upward at a flat angle a part of the reinforcement. In slabs, stirrups are unnecessary, since failure occurs in the center under usual conditions, invariably Stage I still being present near the points of support even at failure, and if diagonal cracks should occur at such

points, the resistance offered by the concrete to the downward pressure of the reinforcement is much greater than is that of the small ribs of T-beams.

Stirrups placed normal to the lower reinforcement are considered the most suitable. Inclined at an angle of 45° , they would seem to be able better to



FIG. 170.—Bursting effect of loose diagonal stirrups.

carry diagonal tensile stresses. In this position the stirrups would resist tension, but there is difficulty in transferring their stress to the lower reinforcement. They tend to slip along the rods and push off the concrete cover around the rods in the ribs, as was observed in some early experiments made by Wayss & Freytag (Fig. 170). A solid connection between diagonal stirrups and the lower rods is troublesome to secure, and

hardly practical. An erect position slightly within the angle of friction would be somewhat better than an exactly vertical one.

4. The necessity, in all designs, of considering the adhesive stresses on the lower reinforcement is clearly shown in the foregoing experiments. In all beams, where a slipping of the straight rods was observed, failure did not immediately result, the remaining structural parts (stirrups and bent rods) often increasing in stress until stretched beyond their capacity. Especially will the nearest bent rod assume the function of the lower chord, in which case in a statical sense the beam becomes one of variable depth. The greater is the resistance to slipping, the greater is the carrying power. (Compare the beams of Fig. 147 with 148, and of 166 with 167).

Thus it is necessary in all beams which act as if of constant depth, and in which all elements perform their desired function up to failure, that the straight rods should also possess proper security against slipping. The most efficacious element appears to be a good form of end hook, somewhat like Fig. 127 and as additional security a correspondingly low adhesive stress τ_1 at the ends of straight rods. Concerning the permissible value of τ_1 , opinion has been divided. In the "Leitsätze," a value of 7.5 kg/cm^2 (107 lbs/in^2) is suggested, while the Prussian Regulations allow only 4.5 kg/cm^2 (64 lbs/in^2). In both cases, the formula,

$$\tau_1 = \frac{b\tau_0}{\text{circumference of reinforcement}},$$

is given, but in the corresponding example in the "Leitsätze," for the circumference of the reinforcement only that of the straight rods is considered, while according to the old Prussian regulations, all the steel can be figured. This fact was not considered by those who accuse the "Leitsätze" and the author of poor judgment.

The point especially involved in the question concerning on which reinforcement the adhesion acts, follows immediately from the experiments, since if only the straight rods are active, a slip would be observed in them, producing a gradual redistribution of internal forces which would lead to failure. Rods

which are bent at three points cannot slip. Stretching and local shifting of the diagonal rods with respect to the concrete will certainly take place, but when they are anchored within the zone of compression, as shown in Fig. 169, any real slip will be prevented. If the hypothetical value of τ_1 is sought with respect to the circumference of only the straight rods, based on the hypothesis of as perfect a supporting power as a beam having only bent rods—then τ_1 must equal ∞ . Naturally, this is impossible, and as soon as such a beam is no longer exactly straight, it should be computed as possessing a bent tension chord.

According to the experiments on rectangular beams with straight rods, and on the basis of the formula $\tau_1 = \frac{b\tau_0}{U}$, an excellent agreement is found with the values of direct adhesion experiments, but it must be noted that this formula is not strictly applicable when bent rods are present. In this case, two ways are open—either the formula $\tau_1 = \frac{b_0\tau_0}{U}$ is simply assumed and the corresponding values ascertained from the experiments (which, obviously, will not agree with those of direct adhesion experiments but will represent simply comparative values), just as was done in regard to the Navier bending formula to find the bending strength of concrete; or it may be assumed that in bending, the same adhesion will be developed as in direct experiments, and endeavor is then to be made to find a suitable formula for τ_1 . Both courses lead to the same result, as far as practical design and security are considered, since that value is used in design which has just been derived by the same method from experiments. (See also page 97).

In Table XXXVI, the values found experimentally of τ_1 at the first slip, are again collected.

TABLE XXXVI

| Beam. | $\tau_1 = \frac{b_0\tau_0}{U}$ | | $\tau_1 = \frac{b\tau_0}{2U}$ | | τ_1 Considering all Rods | | Variety of Reinforcement | | | |
|---|--------------------------------|---------------------|-------------------------------|---------------------|-------------------------------|---------------------|--------------------------|----------|----------|------|
| | kg/cm ² | lbs/in ² | kg/cm ² | lbs/in ² | kg/cm ² | lbs/in ² | Rods | Ends | Stirrups | |
| Wayss and Freytag..... | IV | 53.6 | 762 | 26.8 | 381 | 15.3 | 218 | Bent | Hooked | None |
| | VI | 32.6 | 474 | 16.3 | 237 | 9.3 | 132 | Bent | Straight | Used |
| Stuttgart, Table No. XXXIII, Beam No..... | 2 | 22.0 | 313 | | | 22.0 | 303 | Straight | Straight | None |
| | 3 | 21.1 | 300 | | | 21.1 | 300 | Straight | Straight | None |
| | 4 | 19.1 | 272 | | | 19.1 | 272 | Straight | Straight | None |
| | 5 | 19.8 | 282 | | | 19.8 | 282 | Straight | Straight | None |
| | 161 | 23.3 | 331 | | | 23.3 | 331 | Straight | Straight | Used |
| Stuttgart, Fig. No..... | 162 | 11.1 | 158 | | | 11.1 | 158 | Straight | Straight | None |
| | 163 | 12.8 | 182 | | | 12.8 | 182 | Straight | Straight | Used |
| | 164 | 14.7 | 209 | | | 14.7 | 209 | Straight | Straight | None |
| | 165 | 28.7 | 408 | 14.4 | 205 | 8.7 | 124 | Bent | Straight | None |
| | 166 | 35.0 | 498 | 17.5 | 249 | 10.6 | 151 | Bent | Straight | Used |
| | 167 | 38.4 | 546 | 19.2 | 273 | 11.6 | 165 | Bent | Hooked | Used |
| | 168 | 36.7 | 522 | 18.4 | 262 | 11.1 | 158 | Bent | Straight | None |

For the beams with bent rods, the value of τ_1 in the first column agrees fairly with that of the experiments in which the rods were pushed through at

high speed. Since in this former case the slipping takes place slowly, the computed values are too high. A better agreement is observed in the value computed by the formula $\tau_1 = \frac{Q}{2zU}$ in the next column, on the assumption of a trussed condition of the beam, when compared with the value found from rectangular beams, and also from direct experiments at slow speed. T-beams without bent rods gave somewhat lower results, since the downward pressure of the rods was less.

According to experiments of the Stuttgart Testing Laboratory* the sliding resistance of embedded lengths of 10 to 30 cm. (4 to 12 in. approx.) had an average of 15.3 to 25.1 kg/cm² (218 to 357 lbs/in²).

From the third column it is seen how inconsistent it is to consider the circumference of the bent rods, in computing τ_1 . Since the beams with bent reinforcement developed less adhesion than the beams containing only straight rods, the conclusion could be drawn that a lessening of the adhesion took place with bending, which cannot be the case. It is readily seen that with a permissible adhesive stress of 4.5 kg/cm² (64 lbs/in²), and taking into account all rods, under these circumstances a factor of safety of only about two is secured against slip of the straight rods.

According to the experiments, the permissible adhesive stress for slabs or beams without bent reinforcement, on the basis of a safety factor against slip of four, can be taken at about 5 kg/cm² (71 lbs/in²), when failure is not to be feared from the shearing stress τ_0 . If that stress is considered too high, a value of 3.5 kg/cm² (50 lbs/in²) should suffice. The security against diagonal tensile cracks and their damaging results is not increased by this means, however.

If bent rods are employed in such amount that they can carry all the diagonal tensile stresses, then a factor of safety of four can be secured with

$$7.5 \text{ kg/cm}^2 \text{ (107 lbs/in}^2\text{) in connection with the formula } \tau_1 = \frac{b_0\tau_0}{U},$$

or

$$3.75 \text{ kg/cm}^2 \text{ (53 lbs/in}^2\text{) in connection with the formula } \tau_1 = \frac{b_0\tau_0}{2U},$$

in which U represents the circumference of the straight rods which extend over the supports; and the hooked ends, which should always be used, will increase the security factor so that it is more than five.

If the bent rods are not all so arranged as to resist the diagonal tensile stresses τ_0 , then a part of the lateral forces can be carried by stirrups. For this part, τ_1 is to be computed according to the first formula, while for the rest, the second formula is to be used, and a stress chosen between 3.75 and 5 kg/cm² (53 and 71 lbs/in²), according to the amount of Q taken by the bent rods and the stirrups.

* Versuche über den Gleitwiderstand einbetonierter Eisen, by Bach, Berlin, 1905, or also No. 22 of the Mitteilungen über Forschungsarbeiten auf dem Gebiete des Ingenieurwesens.

It is recommended in this connection that the whole of the diagonal tension near the points of support be taken by the bent rods, even though stirrups be employed throughout the whole length of the beam, and effective hooks are placed on the ends of the straight rods.

5. With reference to the foregoing recommendation, the method can be followed which is shown in the sketches of T-beams of Figs. 171 and 172.

In Fig. 171 a double intersection truss is assumed, in which the bent rods S_1 , S_2 , and S_3 are designed to carry the whole of the diagonal tension τ_0 . According to the method of Fig. 142 and page 160, the forces S_1 , S_2 , and S_3 are represented by the shaded areas shown at an angle of 45° , which areas are to be multi-

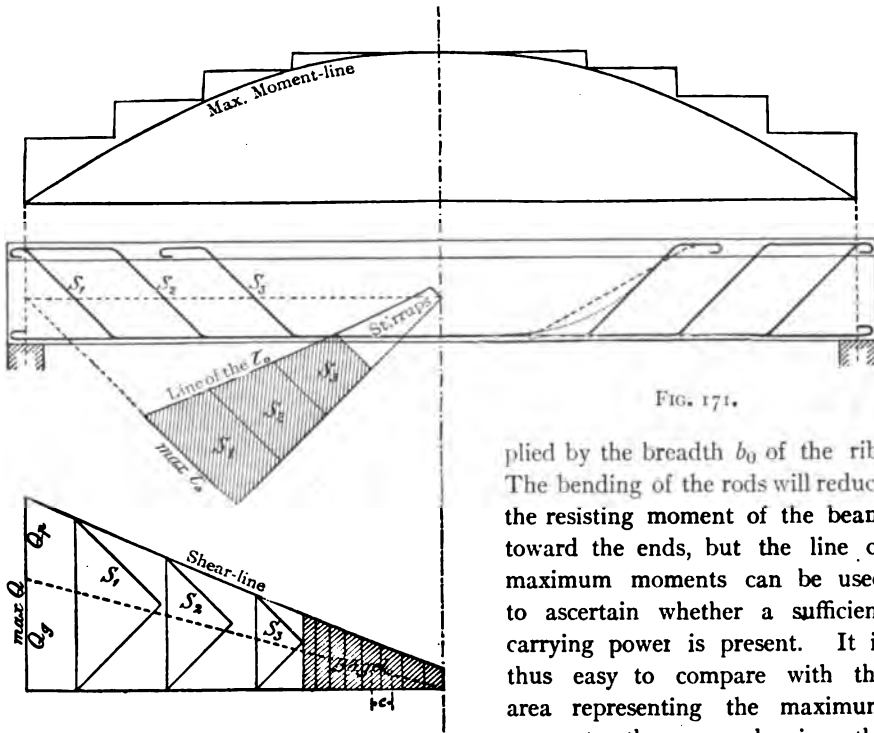

FIG. 171.

plied by the breadth b_0 of the rib. The bending of the rods will reduce the resisting moment of the beam toward the ends, but the line of maximum moments can be used to ascertain whether a sufficient carrying power is present. It is thus easy to compare with the area representing the maximum moments the area showing the

moment which the beam can carry at each point, so that the lower reinforcement may not be stressed beyond the allowable limit at the points of bend. Where the bent rods are discarded for resisting the moment, the method gives results favorable to the moment diagram and therefore on the safe side.

The reëntrant angles of the corresponding polygon should lie outside the curve bounding the area of maximum moments. So much straight reinforcement must be carried over the supports that τ_1 will be between 7.5 and 3.75 kg/cm² (107 and 54 lbs/in²).

When the bending is done so as to correspond with the diagonal members of a double intersection truss, the forces S_1 , S_2 , and S_3 can also be determined by a resolution of the lateral forces of the corresponding panels, as is illustrated in the lower diagram of Fig. 171. In a single intersection system S would equal $Q\sqrt{2}$.

If computations are made with partial live load, as it is well to do in all cases, then the lateral forces are not zero at the center, and to care for them the bending of the rods must be started so soon that not enough steel will remain to care for the moments. Although a certain arch-like diminution of shearing stress takes place, it seems wise to provide some structural elements. As such, stirrups are most easily available, and they can be computed on the assumption that they carry all the lateral forces in a length equal to z . If e is the stirrup spacing, then the force in a single stirrup is

$$B = \frac{Qe}{z}$$

For general reasons already given, a certain stirrup spacing (20 to 30 cm.—8 to 12 ins.) should not be exceeded, and they should be employed even where the rods are bent. As a further precautionary measure the inner bend may be somewhat flatter, or a greater rounding of its angles be made, as is shown by the dotted line on the right-hand half of the sketch.

In Fig. 172 the bent parts are closer together, and a part of the lateral force

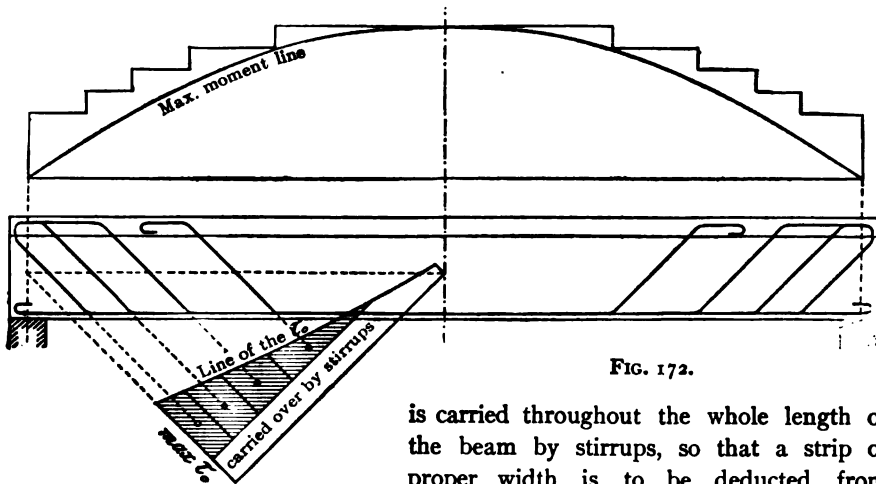

FIG. 172.

is carried throughout the whole length of the beam by stirrups, so that a strip of proper width is to be deducted from the area for τ_0 . If the tensile strength of

a single stirrup is B , then the breadth of this strip is $\frac{B}{eb_0}$. The bent rods correspond to equal parts of the τ_0 -area, if the rods are all of the same size.

The German "Ausschuss für Eisenbeton" also includes in its program, experiments to make clear the action of shearing forces. Upon completion of these tests, opportunity will be given of proving the accuracy of the ideas and methods here set forth.

6. Security against cracking of T-beams. While it can be concluded, from bending tests of rectangular reinforced concrete beams, that sufficient security against the appearance of the first tension crack is provided when the methods of design contained in the "Leitsätze" are followed, as a matter of fact the same has not yet been established for beams of T-section. Here, the amount of

reinforcement is much greater in relation to the concrete subjected to tension, so that the tensile stresses in the concrete are not great enough to diminish those in the reinforcement so that tension cracks in the concrete will be avoided. Consequently the security against cracking decreases with increase of the percentage of reinforcement in the ribs. According to the experiments cited in Table XXXII, page 172, in Beams I, III, IV, V, VI, with a reinforcement amounting to 2.18% of the area of the rib, the first crack was observed at a stress computed at approximately 700 kg/cm² (9956 lbs/in² (according to Stage II *b*). In Beam II, with 1.09% of reinforcement, the computed steel stress rose to 1200 kg/cm² (17068 lbs/in²). The tension in the concrete, computed according to Stage I, with $n=15$, is given in the several descriptions of the tests, and varied between 20 and 27 kg/cm² (284 and 384 lbs/in²). The results of the experiments of the Stuttgart Testing Laboratory concerning the appearance of the first crack, are gathered in Table XXXVII. The amount of reinforcement in the T-sections is given as a percentage of the concrete area between the bottom of the beam and the top of the slab and of a breadth equal to that of the rib.

TABLE XXXVII

| Beam | | Reinforcement % | First Crack Observed between the Limits. | | | |
|------------|----------|-----------------|---|---------------------|--|---------------------|
| | | | Steel Stresses According to Stage II <i>b</i> | | Concrete Tensile Stresses According to Stage I with $n=15$ | |
| Figure No. | Stirrups | | kg/cm ² | lbs/in ² | kg/cm ² | lbs/in ² |
| 162 | None | 1.79 | 773-839 | 10994-11947 | 33.3-36.0 | 474-512 |
| 163 | Used | 1.79 | 747-812 | 10624-11549 | 32.3-35.2 | 459-501 |
| 164 | Used | 1.79 | 642-728 | 9131-10354 | 27.7-31.4 | 394-447 |
| 165 | None | 1.82 | 725-808 | 10312-11492 | 32.3-36.0 | 459-512 |
| 166 | Used | 1.82 | 680-744 | 9672-10582 | 29.6-32.3 | 421-459 |
| 167 | Used | 1.82 | 699-762 | 9942-10838 | 30.5-33.3 | 434-474 |
| 168 | Used | 1.82 | 753-785 | 11477-11165 | 33.2-34.6 | 472-492 |

The directly observed tensile strength of the concrete was about 13 kg/cm² (185 lbs/in²).

Similar stresses in the reinforcement, between 600 and 700 kg/cm² (8534 and 9956 lbs/in²) were observed by Schüle, and reported in the *Mitteilungen der Eidgenössischen Materialprüfungsanstalt, Zurich, No. X.*

The first tension cracks in the concrete, which are so fine that they cannot be discovered on rough, unpainted surfaces of beams, need give no anxiety unless the tensile strength of the concrete has been included in making calculations. This should rarely be done, however. When, with the usual arrangement, the practically invisible cracks are exactly crossed by a needful amount of reinforcement, there is nothing to fear, because this condition is found in the greater number of well constructed reinforced concrete structures, many of which are subjected to very severe conditions. No danger of rust need be considered, since the covering which affords protection against it does not consist of the porous concrete but rather of the cement film immediately covering the steel. Furthermore, the first cracks along the edges do not usually extend entirely to the reinforcing rods.

Nevertheless, if it is desired to design T-beams which will be wholly free from cracks, it is necessary to use broader concrete ribs or less reinforcement. In consequence, however, the design of many buildings with T-beams will be uneconomical, and it will be better to employ some form of arch construction. In usual building work, absolute freedom from rusting is generally unimportant, so that excessive care need not be exercised.

SHEARING STRESSES IN BEAMS OF VARIABLE DEPTH

In the use of reinforced concrete, it often happens that the depth of a beam is increased where the moment is greatest. Figs. 173-176 show the usual arrangements for positive and negative bending moments.

The direction of the section to be made for purposes of computation cannot be assumed at random, since, in the neighborhood of the outside layers, the compressive stresses act parallel with them, and the steel stresses naturally act in the direction of the rods. In order to simplify the derivation of formulas for τ_0 , however, the section will be assumed as vertical, since otherwise it would involve lateral forces, and should also rigorously take account of bending and of axial pressure. For all the cases shown in Figs. 173-176, when only vertical loads are assumed

$$D = Z = \frac{M}{z},$$

so that the increment of Z in the adjacent section is

$$dZ = \frac{zdM - Mdz}{z^2},$$

or

$$\frac{dZ}{dl} = \frac{1}{z} \frac{dM}{dl} - \frac{M}{z^2} \frac{dz}{dl}.$$

Further, in all cases,

$$\frac{dM}{dl} = Q,$$

and

$$b \tau_0 \times dl = U \tau_1 \times dl = dZ.$$

In Figs. 175 and 176,

$$U \tau_1 \frac{dl}{\cos \alpha} = \frac{dZ}{\cos \alpha},$$

The arm z of the couple between tension and compression may be assumed as equal to $\frac{7}{8} h$ for all practical purposes, so that, with

$$\frac{dz}{dl} = \frac{7}{8} \frac{dh}{dl} = \frac{7}{8} \tan \alpha,$$

there is obtained

$$b \tau_0 = U \tau_1 = \frac{Q}{z} - \frac{7}{8} \frac{M}{z^2} \tan \alpha.$$

This is a less value than if the height were constant, since the second quantity is subtracted from $\frac{Q}{z}$. If the formula is written

$$b \tau_0 = \frac{Q - \frac{7}{8} \frac{M}{z} \tan \alpha}{z} = \frac{Q - \frac{7}{8} Z \tan \alpha}{z} = \frac{Q - \frac{7}{8} D \tan \alpha}{z},$$

it is evident that in comparison with a beam of constant depth, instead of the total shear, a value found by diminishing it by $\frac{7}{8} D \tan \alpha$ is to be used in computing τ_0 .

If, in Figs. 173-174, the resultant pressure is assumed as inclined in the direction of a line connecting the centroids of compression in adjacent sections, then

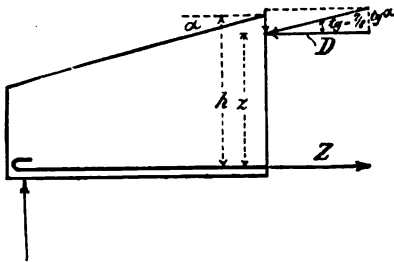

FIG. 173.—Positive Bending Moment.

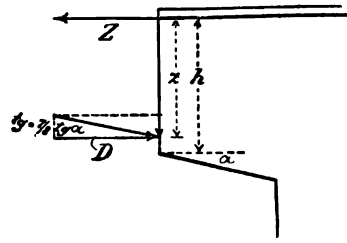

FIG. 174.—Negative Bending Moment.

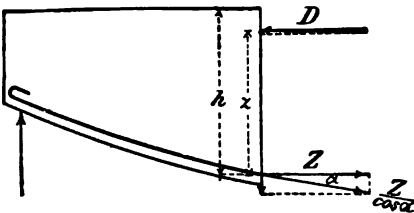

FIG. 175.—Positive Bending Moment.

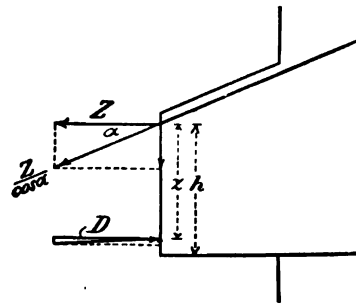

FIG. 176.—Negative Bending Moment.

since D must be its horizontal component, the subtractive quantity $\frac{7}{8} D \tan \alpha$ can be none other than its vertical component. Since the compressive stresses act on layers parallel to this direction, this deduction is entirely plausible. In Figs. 175-176, the resultant pressure may be assumed as acting in the direction of the line connecting its points of application, and the quantity represents the difference between the vertical components of the upwardly directed pressure and the downwardly inclined tension.

In the equation for $b \tau_0$ is seen the beneficial influence of arching the inter-

mediate sections of a continuous reinforced concrete beam. If the moment increases with decrease of h , then the minus sign in the formula is to be changed to plus.

DEFORMATION

Concerning the experiments already described on page 105, it was said that the concrete, because of its tensile strength, relieved the stress in the reinforcement to some extent, and that in Stage IIb this condition also existed to an even greater extent. Because of this action, the deflections of reinforced concrete structures are generally very small. It is to be further noted that because of the fixed connection between all parts of a reinforced concrete structure, more structural parts contribute to the support of the loads than are usually considered in making computations.

In researches concerning structural bridges, deformations are given a considerable importance at the present time, but without proper foundation it would seem, since the total deformation is the result of a large number of very small elastic deformations of the various parts and sections. Thus, it is impossible to trace in the computed total deformation the effect of one or more defects in a member, such as a poor rivet, etc., comprising, as it would, such a small part of the whole; but a fairly exact determination can and should be made of the whole structure, on the basis of known causes.

The amount of deformation of any reinforced concrete construction is of even less value as a measure of its quality, since adequate determinations of the influence of shearing and adhesive stresses are wanting, and since the distribution of load within the construction cannot be followed with mathematical exactness. If one cannot leave matters to the experience of the company executing the work, nothing remains but to become familiar with the details of construction and design in order to be sure of the necessary care during construction.

When exact experimental knowledge as to the safety of the structure is to be brought into the question, the size of the actual stresses produced in steel and concrete should be known, and they can best be determined during an experiment by means of a suitable measuring device (such as a Rabut-Manet). In this instance the deformations are not determined indirectly.

In Fig. 177 are given the deflection diagrams of the tests described on page 95 (Fig. 88). The constant bending moments at the centers are plotted as abscissas, and the resulting deformations as ordinates. The circles on each curve show the permissible loading according to the "Leitsätze."

The condition of the curves up to these points is practically rectilinear, but at the appearance of the first crack an upward turn takes place. That is, a sudden increase in the deflection occurs, so that the conclusion may be drawn that in reinforced concrete slabs, cracks actually exist at those points. For T-beams, the courses of the curves are similar.

According to these diagrams, the action of a flexed reinforced concrete beam is such as to give a deflection diagram consisting of two straight lines with a transition curve between them. The first part starting from the origin corresponds with stresses in Stage I, in which the concrete yet exerts tension. The

broken line connecting the two parts corresponds with Stage IIa, in which the tensile strength of the concrete has reached its ultimate point, and finally the commencement of Stage IIb, where at several points the tensile strength has been exceeded and fine cracks appear. The further practically rectilinear character of the curve corresponds with Stage IIb, with increasing cracks, during which the reinforcement is prevented from stretching indefinitely only by the practically constant condition of the resistance offered to its sliding, by its concrete covering. Consequently, here, the deflection is not proportional to the load.

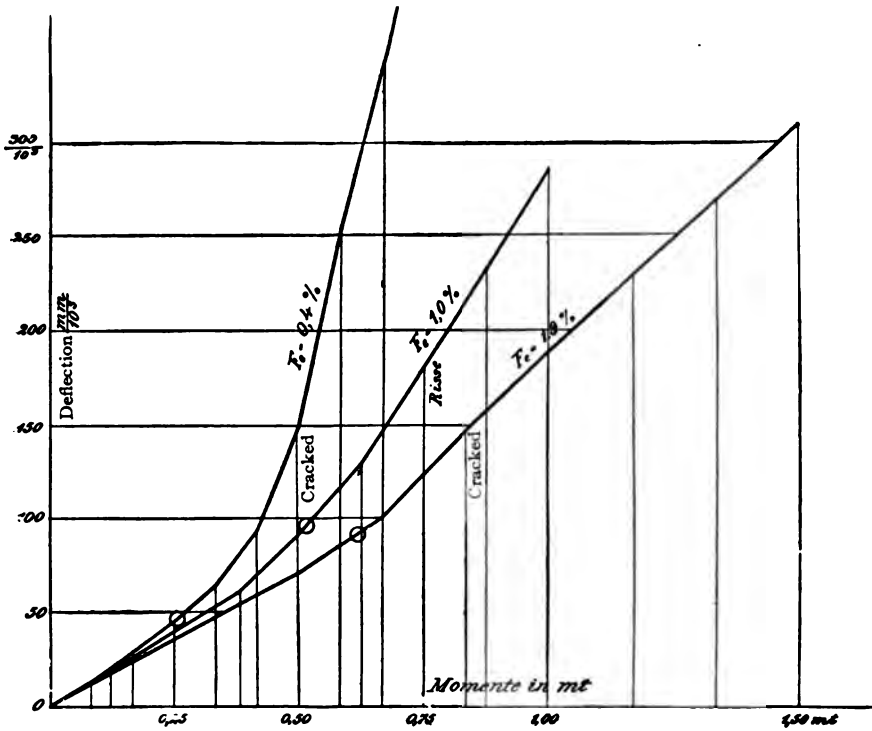

FIG. 177.—Deflection diagrams of beams of pp, 100, 101.

A mathematical determination of the deflection must thus fit these several conditions. For Stage I, computations can be carried out according to the usual theories of flexure, but the expression for the moment of inertia must have the sections of reinforcement replaced by n -fold larger ones of concrete. The kind of deflection in Stage IIb makes its computation impossible, since its determination rests on the average stretch in the steel, the spacing of the tension cracks and the frictional resistance between the steel and concrete. Also, a method of computation for Stage IIa, during which the stress condition (up to the appearance of the first crack) is quite accurately known, is equally shown to be out of the question, since the special formulas (p. 138) for x and σ_b show that it is not possible to find a serviceable expression for the angle between the adjacent sections, when it is recognized that β must first be approximately determined through deductions from experiments.

COMPUTATION OF FORCES AND MOMENTS

In the foregoing pages it has been shown how to compute the stresses in a section, produced by known moments and normal forces, and how structural parts should be designed. In the following paragraphs will be discussed the general case of the computation of lateral forces and moments.

While it is usually sufficient to know simply the maximum moment which may occur at any point within the span of a steel beam of constant area (such as any rolled section), and in some cases also of plate girders; for an economical design of reinforced concrete beams, the maximum moments of both kinds must be known for a large number of sections. Above all, it is necessary to know in which direction the moment acts, since the location of the reinforcement in the beam depends upon it. As has been shown, the lateral internal forces, such as the shearing stresses, play a considerable part in the design of the sections of reinforced concrete beams. A further condition which must be included in designing is that the permissible stresses of each of two different materials must not be exceeded. On the other hand, a much simpler form of cross-section is to be dealt with.

For all statically determined reinforced concrete construction, the bending moments are to be computed from the exterior forces according to the rules of statics. The question arises, however, whether for statically indeterminate reinforced concrete construction, such as restrained and continuous beams, arches without hinges, etc., the stresses are to be determined in the same manner as for homogeneous materials.

It was shown by Spitzer in the *Zeitschrift des Osterreichischen Ingenieur- und Architektenvereins*, in connection with the Purkersdorfer test of a Monier arch, that his method of calculation may be followed, as may also the elastic theory as applied to homogeneous materials, when the area of reinforcement is replaced by an n -fold greater area of concrete in all expressions for areas F and moments of inertia J . It is to be noted that in bending with axial pressure, as in an arch, the tensile strength of most sections is not involved, since the action of the moment and of the pressure are to be added in the same manner as for homogeneous sections.

A restrained or continuous T-beam in which no axial force acts will not be considered. So long as the angle of inclination between two adjacent sections is proportional to the bending moment, the methods of computation for restrained or continuous beams are to be followed. According to the deflection diagram, this proportionality between moment and deformation in rectangular sections continues up to the maximum permissible loading. But even when the proportionality ceases with higher loading, the stress distribution is not greatly altered, as the following simple cases show:

As an extreme case it will be assumed that the angle of inclination between the adjacent sections is proportional to the third power of the moments (so that the deflection diagram of Fig. 177 would be a cubical parabola), and thus

$$d\phi = C M^3 dx,$$

wherein C represents some constant.

For a beam fixed at both ends, and carrying a concentrated load P at the center,

$$M_x = -M_1 + \frac{P}{2}x,$$

$$d\phi = C M_x^3 dx = C \left(-M_1 + \frac{P}{2}x \right)^3 dx.$$

It must happen that

$$0 = \int_0^l d\phi = \int_0^l \left(-M_1 + \frac{P}{2}x \right)^3 dx.$$

The solution gives the well-known moment

$$M_1 = \frac{Pl}{8}.$$

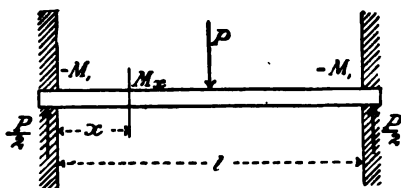

FIG. 178.

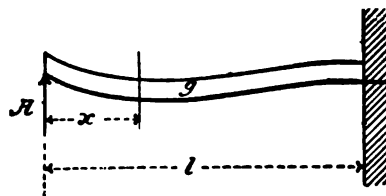

FIG. 179.

An unsymmetrical case will be selected of a beam in which one end is fixed and the other freely supported, Fig. 179,

$$M_x = A x - \frac{g}{2}x^2,$$

$$d\phi = C \left(A x - \frac{g}{2}x^2 \right)^3 dx.$$

Since the end of the beam at A cannot move vertically,

$$0 = \int_0^l x d\phi,$$

or

$$0 = \int_0^l x \left(A x - \frac{g}{2}x^2 \right)^3 dx,$$

The equation derived from the integration of this expression is satisfied with $A = \frac{3}{8}gl$, the known proper value on the basis of a frictionless support.

It may be concluded from these two cases that a relation differing from true proportionality between moment and deformation makes no appreciable change in the section, from that found by pure elasticity formulas. The propriety of computing continuous reinforced concrete beams as such, will be determined from the experiments hereafter described, made by the firm of Wayss & Freytag,

upon continuous reinforced beams. The assumptions on which the success of the test rested were, that the reinforcement should conform to the conditions of restraint and continuity and not be arranged simply according to some "System." It is often forgotten that the elastic conditions in homogeneous materials hold only while strict proportionality lasts, and that thus with regard to the distribution of stress at rupture, the same uncertainty exists as with reinforced concrete.

Reinforced concrete beams and slabs can be computed by the formulas for continuous beams of constant section with as much reason as continuous structural

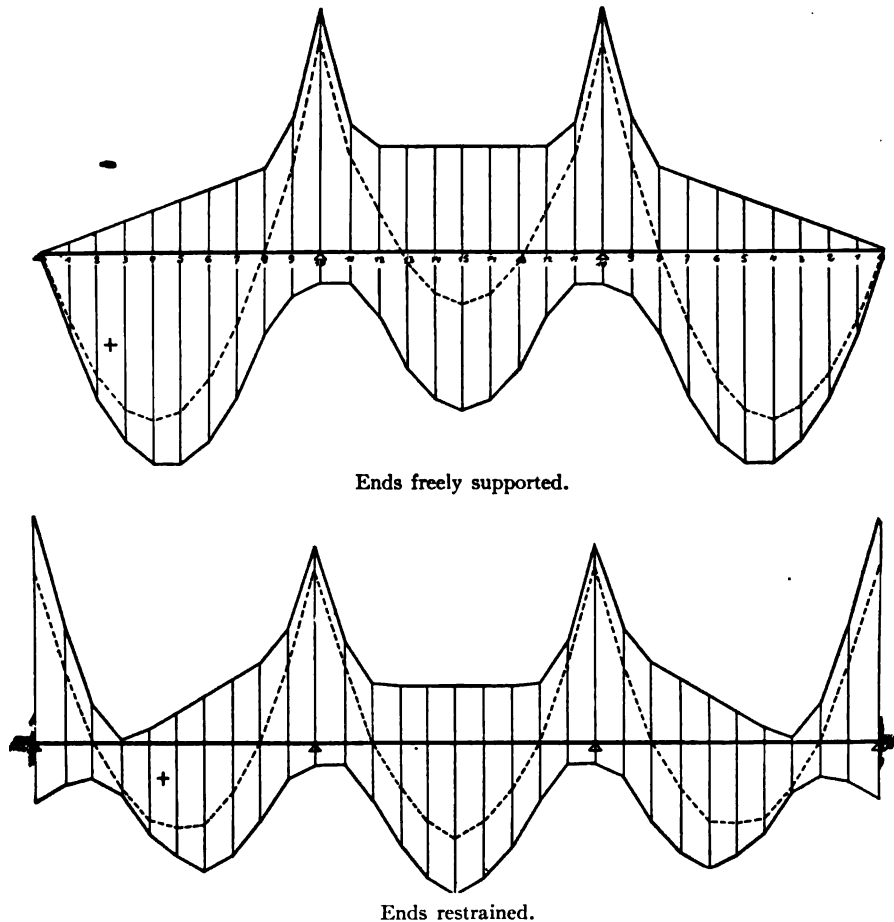

FIG. 180.—Maximum moment lines for continuous beams of three spans.

beams are designed on the assumption of a constant moment of inertia, when the area changes; that is, when the maximum moment is employed.

Computations will actually be too favorable, if, for sake of simplicity, the slabs over the ribs and the ribs themselves over the intermediate columns, are considered as freely supported (although really continuous members), and the restraint of the beams at the columns is ignored. However, the saving which exact computations would make, could be only insignificant. The restraint of the end panels

of slabs at the outside walls can only in rare cases be secured through structural measures, and is at best very uncertain, even though the same method is maintained at the ends and some reinforcement bent upward in the vicinity of the supports.

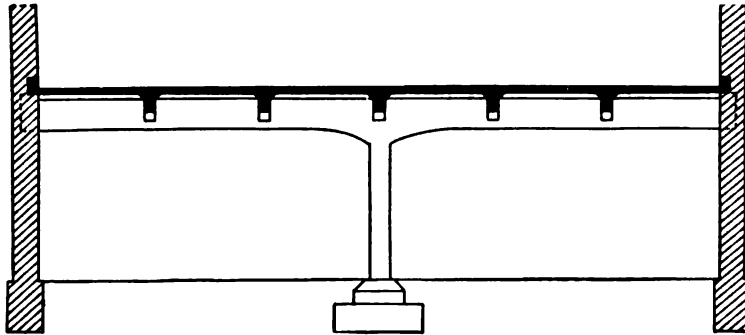

FIG. 181.

The restraint afforded at the ends of T-beams which rest in walls is even less. If the beams are supported by wall columns, a certain amount of restraining action is produced, which may be included in computations under certain circumstances. The wall columns should always be built to resist bending.

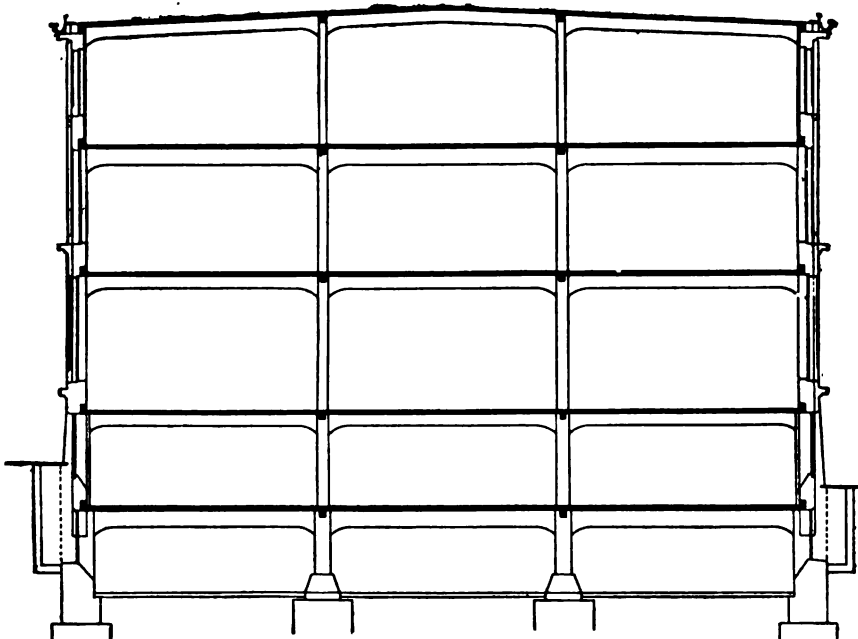

FIG. 182

The girders shown in Fig. 181 support a reinforced concrete floor and are continuous beams of two spans freely supported at the ends. Those of Fig. 182 are to be designed as continuous beams of three spans with partial restraint of the

ends by the wall columns which are built in the outside walls, and support the ends of the beams.

The computations for a uniformly distributed load in the simplest form, from the ordinates of the maximum moment line for continuous beams is given by Winkler, in Vol. I of "Vortrage über Brückenbau." His tables are reproduced in the appendix, and are of considerable value in connection with the computation of continuous beams. The maximum moment line for three spans is given in Fig. 180. Of considerable value, also, are the interpolation tables for the ready determination of the influence lines for moments and shears in continuous beams, prepared by Gustav Griot, Zurich. A further discussion of the computation of such moments will not be given, since the various methods are to be found in text-books of the statics of building construction.

For many reasons, the "remnant" stresses in reinforced concrete construction are of considerable importance. It so happens that the concrete, especially on the tension side, undergoes, by the first loading, a certain permanent deformation in addition to the elastic one, which causes certain permanent stresses in both materials, because of the connection between the steel and the concrete. These permanent stresses can but slightly influence the ultimate load through repetition, since with repeated loading, the concrete correspondingly alters its coefficient of elasticity, which corresponds rather to the final deformation than the one produced by the first application of load. Thus, when it is stated that reinforced concrete beams which have been subjected to bending have a residual compression in the lower concrete, due to the reaction of the steel against the permanent stretch produced in the concrete by the first loading, it must also be considered that with repetition of load this compression in the concrete invariably must first be overcome before tensile stresses appear therein; that, further, the concrete is not so readily extensible after the first time; and that the tensile stresses quickly increase, so that the final value is again approximately equal to the first one. Aside from this fact, the residual concrete stresses would have some importance for the designer if they exerted an influence upon the ultimate stresses in the loaded condition of a beam, since he would then have to employ in his designs a very much lower resistance to load (Stage IIb with cracked concrete), so as to provide a proper factor of safety. However, these "remnant" concrete strains and stresses have little influence upon this condition.

The careful determination of the actual stresses in the steel and concrete under permissible loads shows them to correspond with those now customary in steel structural work, but this is no reason why they should be advocated for reinforced concrete. In an earlier chapter it was shown in several cases that many of the methods adopted by custom in reinforced concrete design, give wholly erroneous results; also that regular steel construction was often superior when one could not employ "safe stresses." (In this connection may be cited, for instance, the experiments of Schüle of Zurich on I-beams, in which the top flange failed by lateral cracking.) Only because designers of reinforced concrete have kept in sight from the outset the safety of their structures, keeping well within the usual stresses under permissible loads wherever possible, has reinforced concrete reached its present development.

The shrinkage of concrete produces secondary stresses in reinforced concrete

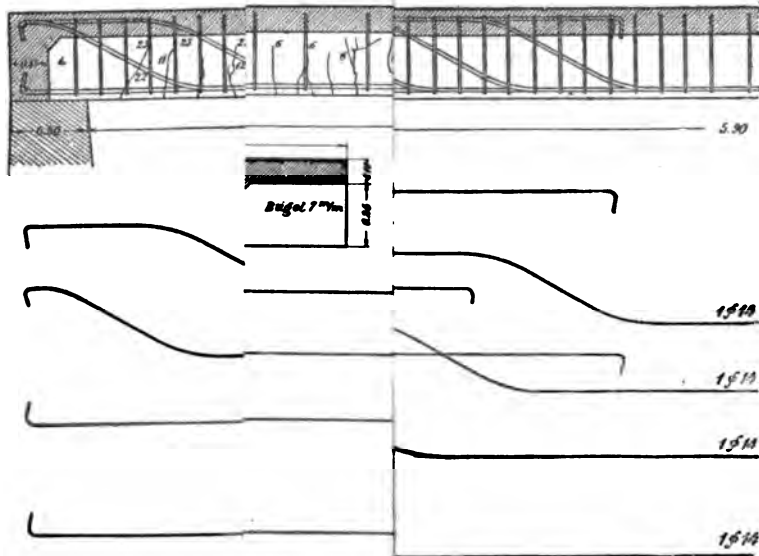
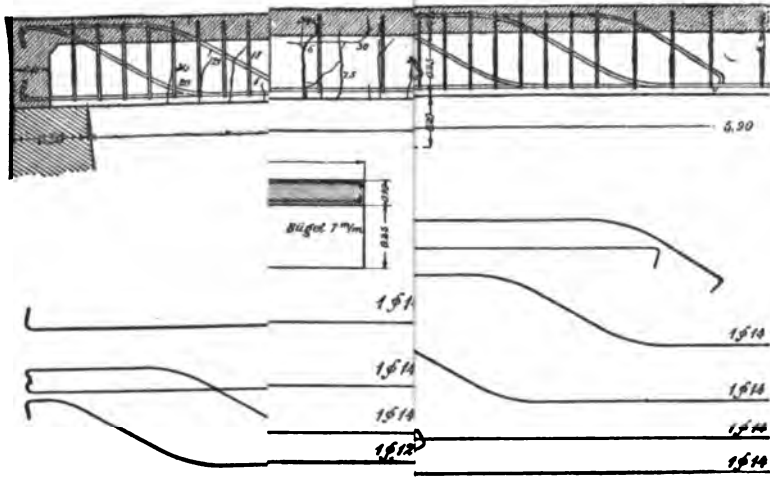

1. 184.—Contin

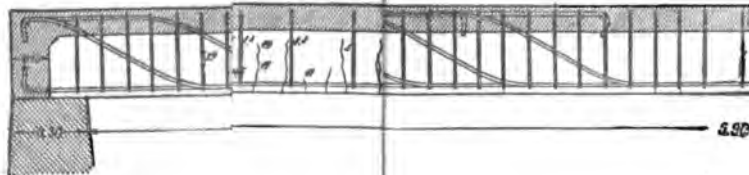

FIG. 185.—Continuous beams but with $\frac{1}{2}$ in. approx. in diameter.

To face page 199.

structures. The amount of this shrinkage bears a definite relation to the proportions of the mixture. In long structures allowance must be made for expansion and contraction from temperature change, by means of expansion joints of suitable size (20 to 40 mm.) ($\frac{3}{4}$ to $1\frac{1}{2}$ in. approx.). In high buildings, the joints can be carried either through the centers of beams and columns or through the panels. The latter arrangement leads to a cantilever construction of the floor and beams. The expansion joint can be constructed without any open space, since it tends only to open because of the shrinkage of the concrete. Buildings provided with such joints actually remain free from cracks, while otherwise the danger of cracks occurring at undesirable points always exists.

EXPERIMENTS WITH CONTINUOUS T-BEAMS

Since experiments with properly constructed continuous T-beams were unknown, and because of the importance of the subject, the firm of Wayss and Freytag carried out tests of three beams of T-section in accordance with plans prepared by the author. The specimens are illustrated in Figs. 183-185. They consisted of continuous beams of two spans each 5.9 m. (19.4 ft.) wide, the ribs of the beams being 14 cm. (5.5 in.) broad and 25 cm. (9.8 in.) high, above which was a slab 1 m. (39.4 in.) wide and 10 cm. (3.9 in.) thick. For sake of stability, lateral ribs were built over the supports. The arrangement of the reinforcement was made in accordance with the moment line for uniformly distributed loading over two openings. The specimens were five weeks old at the time of the test.

Beam I showed the usual arrangement of continuous reinforced concrete beams, with haunches at the center support. Since the dead load amounted to 325 kg/m (218 lbs/ft) a live load of equal amount would produce a total of 650 kg/m (436 lbs. per running ft.) under which the reaction at the left support would be $Q=650 \times 6.15 \times \frac{3}{8} = 1500$ kg. (3300 lbs.), so that $\tau_0 = 3.6$ kg/cm² (51 lbs/in²). Since the bent reinforcement was ample at that point to resist the diagonal tension, the adhesion could be computed according to the formula $\tau_1 = \frac{Q}{2zU}$ and this gave $\tau_1 = 2.85$ kg/cm² (41 lbs/in²), so that a large factor of safety was secured at the ends.

At 0.4l the bending moment under the same load would be

$$M = 0.07 \times 650 \times 6.15^2 \times 100 = 172090 \text{ cm.-kg. (153385 in.-lbs.)}$$

and consequently,

$$\sigma_e = 1000 \text{ kg/cm}^2 \text{ (14223 lbs/in}^2\text{), and } \sigma_b = 17.4 \text{ kg/cm}^2 \text{ (247 lbs/in}^2\text{).}$$

Over the center pier the computed stresses were

$$\sigma_e = 990 \text{ kg/cm}^2 \text{ (14081 lbs/in}^2\text{), and } \sigma_b = 45.7 \text{ kg/cm}^2 \text{ (649 lbs/in}^2\text{).}$$

At a total load of 6t. (6.6 tons) on both spans, the first cracks had already appeared in the region of the greatest positive moments, and at 14t. (15.4 tons) they showed themselves at the points of negative moment. With increase of load, somewhat later slightly diagonal cracks followed in the outer zones of positive and negative moment. Between these two regions at points about $\frac{1}{4}$ l from the end, where the moment was zero, a space in the beam remained with no cracks up to the ultimate load. At those points, the principal stresses were of shear, which were carried by the bent rods, according to the computations made above. From the distribution of cracks, which are shown for only one span in Fig. 183, it is clear that a theoretically continuous reinforced concrete beam which is actually so constructed will act as such.

Rupture resulted at a load of 34.4t. (37.8 tons), from crushing of the concrete on the under side of the haunches. This occurred at a point where a stirrup had been displaced by the ramming of the concrete, so that the stirrup spacing was 24 cm. (9.4 in.) as that point, instead of 15 cm. (5.9 in.). The two round rods of 10 mm. ($\frac{3}{8}$ in.) diameter, were buckled in consequence, in the manner shown by the photograph in Fig. 186. A compression reinforcement thus shows



FIG. 186.—Beam I, Cracks and Rupture in the vicinity of the intermediate support.

itself of value, when it is prevented from buckling by closely placed stirrups, but otherwise it may be an actual detriment. Simultaneously, with the break at the center support, one also took place at 0.4l, since with the giving way of the haunch the positive moment was considerably increased so that failure naturally resulted at that point.

For the ultimate load of 34.4t. (37.8 tons), when the dead weight is also considered, the computations give

$$\tau_0 = 17.3 \text{ kg/cm}^2 \text{ (246 lbs/in}^2\text{)},$$

$$\tau_1 = 13.7 \text{ kg/cm}^2 \text{ (195 lbs/in}^2\text{)}.$$

At 0.4l, according to Stage IIb, there results

$$\sigma_e = 4800 \text{ kg/cm}^2 \text{ (68,273 lbs/in}^2\text{)},$$

$$\sigma_b = 83.5 \text{ kg/cm}^2 \text{ (1188 lbs/in}^2\text{)}.$$

When the steel stress is computed at the time of rupture with the arm of the couple at 32 cm. (12.6 in.), it is found to be 4450 kg/cm² (63,294 lbs/in²). At the point where the concrete was crushed on the haunch, the moment of the continuous beam (computed for a constant section) equals 7.0 m-t. (25.3 ft.-tons). From this there results

$$\sigma_e = 3700 \text{ kg/cm}^2 \text{ (43,626 lbs/in}^2\text{),}$$

$$\sigma_b = 171 \text{ kg/cm}^2 \text{ (2432 lbs/in}^2\text{),}$$

so that the destruction of the concrete at this point is adequately explained. If it is further considered that the compression acted parallel to the under side, and that the stress computed for a vertical section is to be divided by $\cos^2 \alpha$, a compression on the concrete of 184 kg/cm² (2574 lbs/in²) is obtained. The shearing stress computed for the section which failed, according to the formula

$$b \tau_0 = \frac{Q}{z} - \frac{7M}{8z^2} \tan \alpha,$$

amounts to $\tau_0 = 9.9 \text{ kg/cm}^2$ (141 lbs/in²).

The horizontal crack at the point of rupture should be noted. At 28.6t. (31.5 tons) it was already visible and corresponded to a shearing of the concrete. At the front end of the haunch, the compression in the concrete acted horizontally, and because of the abrupt change of direction of the lower edge, the concrete of the haunch could only be affected by horizontal shearing stresses in a way to alter the [direction of the.—TRANS.] compressive forces. Since the change is abrupt, the principal stresses cannot develop at that point, and moreover the transfer may be supposed to take place through a sort of tothing, as in the case of plain shear (Fig. 33). The danger of this horizontal shear is the greater, the steeper is the haunch. Flat and especially rounded transitions are therefore preferable.

Beam II had no haunches, the upper reinforcement at the center support being increased over that of Beam I so as to give equal carrying power, and the lower side was strengthened against compression by a spiral of 10 mm. ($\frac{3}{8}$ in.) round steel, with a diameter of 10 cm. (3.9 in.) and a pitch of 3 cm. (1.2 in.). Since the shearing stresses were greater because of the absence of a haunch, two extra shear-rods were introduced (Fig. 184).

The distribution of cracks was just the same as in the foregoing beam, only the point of zero moment occurred somewhat nearer the center support (which is in accord with theory), because the larger section near the center pier of Beam I would move the point of zero moment further into the span. The stresses computed for the section with maximum positive moment at the load of 31.9 t. (35.1 tons) which produced rupture of the concrete on the lower side near the center support, were

$$\sigma_e = 4250 \text{ kg/cm}^2 \text{ (60,449 lbs/in}^2\text{).}$$

$$\sigma_b = 76.6 \text{ kg/cm}^2 \text{ (1089 lbs/in}^2\text{).}$$

Since failure occurred in this section at the same time with that of the concrete at the center support, σ_e was relatively the same at the two points, just as in Beam I. When the bending moment and corresponding stresses are computed for the point of failure located about 0.3 m. (0.98 ft.) from the axis of the center support, there result at the instant of failure $\sigma_e = 3315 \text{ kg/cm}^2$ (47,150 lbs/in²), and $\sigma_b = 311 \text{ kg/cm}^2$ (4423 lbs/in²). Because of the 50 cm. (19.7 in.) breadth of the supports, a certain added security was attained at those points, so that these figures are rather too small than too large.

The diagonal cracks cutting the shear rods, were apparent at a load of 16 t. (17.6 tons), corresponding to a shearing stress of $\tau_0 = 15.5 \text{ kg/cm}^2$ (220 lbs/in²). There, the vertical pressures between the concrete layers produced by the reaction of the support, acted to delay the appearance of the first shear crack, as did



FIG. 187.—Beam II, Cracks and Rupture in the vicinity of the intermediate support.

also the shear rods and the stirrups. The adhesion must be computed at those points for the circumference of the upper reinforcement, and was 6.1 kg/cm^2 (87 lbs/in²) at failure, according to the formula $\tau_1 = \frac{Q}{2zU}$. Since in continuous beams, an abundance of steel is to be found over the intermediate supports, the adhesion there will always be found low in computed value.

Beam III was constructed exactly like Beam II, except that the two 14 mm. ($\frac{9}{16}$ in.) shear rods were omitted and the upper 14 mm. reinforcing rod was increased to 20 mm. ($\frac{3}{4}$ in.). The distribution of cracks as shown in Fig. 185 was like that of Beam II. Failure again occurred through rupture of the lower concrete near the center support, while failure also took place at the point of maximum positive moment at the same time that the ultimate carrying power was exceeded at the other point. With the failure of the concrete on the under side, indications also existed of a shearing of the concrete in a horizontal direction just above the spiral (Fig. 188). Since the breaking load reached only 25.4 t. (27.9 tons), when compared with Beam II the utility of special shear rods is disclosed. These may be unnecessary when the main reinforcement can be bent at the desired points without reducing its area below that clearly necessary to resist the negative moments.

Experiments with continuous beams are more difficult to execute than those on simple beams, since an inequality in the loading affects the results. The firm of Wayss & Freytag will repeat these experiments with somewhat heavier reinforcement near the ends, and also make two other beams without spirals or haunches.

From the foregoing results, the effect of lack of haunches in continuous reinforced concrete beams can be seen. Their economic value is shown in the follow-

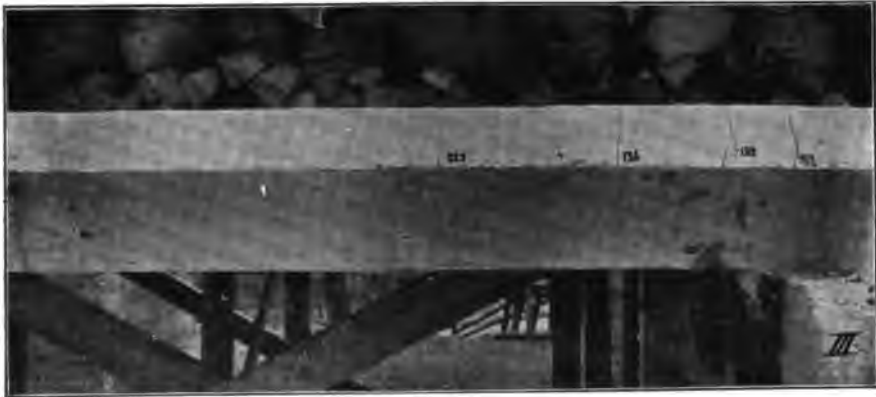

FIG. 188.—Beam III, Cracks and Rupture in the vicinity of the intermediate supports.

ing table, which gives the amount of the main reinforcement including the spirals but omitting the stirrups:

| Beam | Ultimate Load | Reinforcement |
|------|---------------|---------------|
| I | 34.4 t. | 75.3 kg. |
| II | 31.9 | 90.0 |
| III | 25.4 | 91.0 |

From these experiments, especially from Beam I, it may be concluded that reinforced concrete beams can be constructed as continuous members. It is believed that they should almost always be so designed when it is considered that all parts of a building of this type are monolithic.

This also necessarily applies to floor slabs carried by reinforced concrete beams, which must withstand the negative moments over the latter, for since they act as the compression chords of the latter, they should not be allowed to become cracked on the upper side next the beams.

PART II

CHAPTER XII

APPLICATIONS OF REINFORCED CONCRETE

HISTORICAL

JOSEPH MONIER, who made the first practical use of it in 1868, is usually credited with being the inventor of reinforced concrete. However, traces of this method of construction are found at an earlier period. For instance, at the Paris Exposition of 1855, Lambot exhibited a boat made of reinforced concrete. At the International Exposition of 1867, besides the better known Monier, François Coignet was represented. Since 1860 he had designed floors, arches and pipes, in the construction of which the fundamental principles of reinforced concrete construction are recognizable.

To Monier, however, belongs the credit of having devoted himself to the new method of construction with perseverance and success.

Originally, he was the owner of an important nursery in Paris. His first attempts were to make large plant tubs which would be more durable than those of wood, and more readily transportable than those of cement. He sought to attain his object by introducing iron rods of small diameter into the cement sides of the tubs, and extended this method of construction to the production of large water tanks. In 1867 he took out his first French patent, which he soon followed with a large number of others on reservoirs, floors, straight and arched beams in combination with floors, etc. In his patent drawings are already disclosed all the elements which are to-day employed in the various construction details of the various systems.

It is easy to understand how Monier's invention, but little understood and based as it was on an entirely empirical foundation, was destined to develop along entirely different lines in the hands of engineers.

In 1884 the so-called Monier patents were purchased by the firms of Freitag and Heidschuch in Neustadt-on-the-Hardt, and of Martenstein and Josseaux in Offenbach-on-the-Main. The first mentioned firm acquired the rights for all of South Germany, with the exception of Frankfort-on-the-Main, and vicinity, which territory was reserved to themselves by the last mentioned firm. At the same time both parties acquired from Monier options for the whole of Germany, which, however, they relinquished a year later to engineer Wayss. The latter, in connection with the above mentioned firms, conducted load tests in Berlin, the results of which were made public in 1887, in the brochure "Das System Monier, Eisengerippe mit Zementumhüllung," on the basis of which Wayss succeeded in introducing the Monier system into public and private edifices.

In that pamphlet, Wayss first expressed the decided opinion that the steel in reinforced concrete construction must be placed where the tensile stresses occur. He perceived that, owing to the extraordinary adhesion of cement concrete to iron, both elements must act together statically, and found his theory confirmed by his numerous tests. The Wayss experiments included not only strength tests of all kinds, but were also extended to include tests of protection against fire, and protection of the embedded steel against rust, as well as of the adhesion of iron to concrete.

Examples were also given in the above mentioned pamphlet explaining the commercial practicability of the new method of construction compared with the older systems. The great capacity of the Monier slabs to resist shock had at that time already been demonstrated. The tests were witnessed by official representatives and private engineers and architects. Government Architect Koenen, now Director of the Actiengesellschaft für Beton- und Monierbauten, in Berlin, was commissioned by Wayss to deduce methods of computation from these tests, which latter were published in the same pamphlet and also in the volume of the "Zentralblätter der Bauverwaltung" for 1886.

Commencing at that time, a theoretical foundation was evolved, according to which the design of reinforced concrete work could be effected, and through these preliminary labors, this method of construction was extensively adopted in Germany and Austria. A turning point in its development was the International Exposition in Paris, in 1900, and the report by Emperger, published at that time in regard to the position which the subject occupied.

Because of the scientific investigation of reinforced concrete during the past few years, it has made rapid progress in Germany. It was specially promoted by the publication, in 1904, through the coöperation of experts and practical men of the "Leitsätze" of the Verbands Deutscher Architekten- und Ingenieurvereine and the Deutschen Betonvereins, as well as by the "Regulations" of the Prussian Government, which abolished many restrictive rules, cleared the way, and inspired in the widest circles confidence in the new method of building.

At the present time, in many countries, commissions are investigating the subject of reinforced concrete. The French Commission has already completed its labors and published its findings in a special report. The German Committee on reinforced concrete has arranged an extensive programme, which is being executed in numerous testing laboratories. Besides this committee, there is the Reinforced Concrete Commission of the Jubilee of the Foundation of German Industries, which continues in existence, and some of the important results of the activities of which have been given in the foregoing matter. The Swiss Commission will complete its work during the next year, and make suggestions for the construction and design of reinforced concrete structures.

In the United States reinforced concrete has been employed for a considerable time, but the wide difference among the systems employed, and the lack of method in their preparation, have prevented rational development. The Ransom, Wilson, expanded metal, etc., systems, have found wide adoption in buildings in that country. The Melan system was introduced into America by F. von Emperger, and came into extensive use in bridge building.

In addition to the Monier system, which was widely developed in France (the land of its origin), a large number of other systems arose there, of which only the names—Cottancin, Bordenave, Coignet, Bonna, Latri, etc.—can be mentioned. The best known system is that of Hennebique, which, at the start, like those of his English and American co-laborers, aimed chiefly at security against fire. It is extensively employed in France, Belgium, and Italy. Hennebique's ideas of construction were not altogether new, perhaps, being contained in part in the Monier patent specifications. Thus, are found, beams reinforced

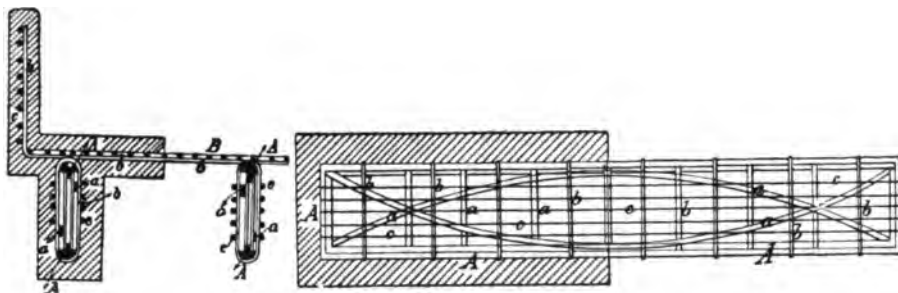

FIG. 189.—Monier's Reinforced Concrete Patent Drawings of 1878.

with similar heavy round rods and wide stirrups, bent rods used in floors, beams, etc. The first reinforced concrete beams in combination with slabs occurred as early as 1886, in connection with the erection of the library in Amsterdam. Since 1892, in chronological order, there followed Coignet, Sanders, Ransome, and then Hennebique.

Of the better known systems for floor slabs and beams, the following may be enumerated: The Monier system (Fig. 190) employs numerous distributing rods at right angles to the supporting rods, the two being wired together at the points of intersection. Formerly, the distributing rods crossing the supporting

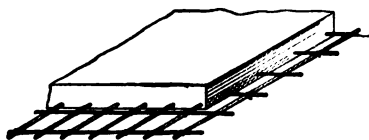

FIG. 190.—Monier System.

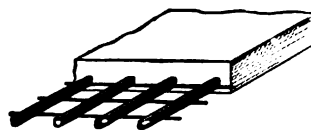

FIG. 191.—Hyatt System.

ones were regarded as a means of preventing the concrete from slipping lengthwise of the supporting rods. When it was realized, however, that the adhesion was sufficient for this purpose, the distributing rods were spaced further apart. The Monier system, or the ordinary grid of round rods spaced 6 to 10 cm. (2.4 to 4 in.) apart, found extensive employment in the construction of reservoirs of every description.

Hyatt (Fig. 191) made the supporting rods of flat iron laid on edge, in which holes were punched, through which were passed distributing rods, made of small round iron.

The Ransome system, Fig. 192, which attained considerable importance in America, suppresses the distributing rods entirely, and uses for the supporting

rods, spirally-twisted square iron, to prevent any slipping in the concrete. Other inventors, like Cottacin (Fig. 193) have woven supporting and distributing rods together, to form a rectangular network.

For continuous floors with steel beams, bent rods in the form of flat iron, to which are riveted angle iron clips, are used in the Klett system (Fig. 195)

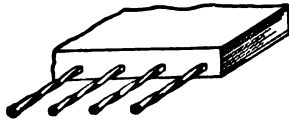

FIG. 192.—Ransome System.

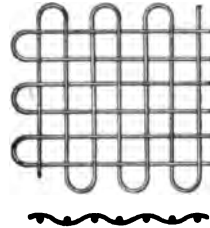

FIG. 193.—Cottacin System.

and the Wilson and Koenen systems (Fig. 194). In the two last-named systems, the slab is made heavier at the supports, as required by the greater moment of a continuous slab at those points. For varying loads, however, a single reinforcement must be regarded as inadequate.



FIG. 194.
Koenen System.

FIG. 195.
Klett System.

The Matrai system incloses in the concrete a network of wires suspended, chain-like, between iron supports, crossing one another so as to form squares.

In the Hennebique system (Figs. 196, 197), the reinforcement of slabs and beams consists of two series of rods. One series is straight and lie in the lower part of the concrete. Over the supports are top rods which are bent down near the center of the span and finally lie close to the straight ones.

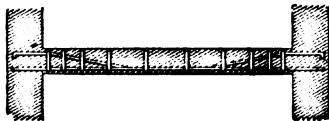

FIG. 196.
Slab of the Hennebique System.

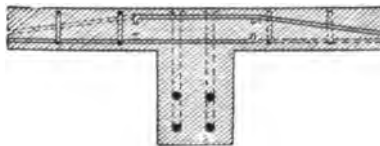

FIG. 197.
Beam of the Hennebique System.



FIG. 198.
Flat-iron
Stirrup.

Hennebique rightly recognizes in the bent rods a preventive of shearing strains and uses them also with slabs and beams which are not restrained. He also uses flat iron stirrups in slabs and beams, of the form shown in Fig. 198.

Hennebique is entitled to the credit of having introduced into construction work, on a large scale, reinforced concrete beams and columns, and of having developed new fields for reinforced concrete work.

The systems of Klett and Wilson, used for floor slabs, in which the reinforcement consists exclusively of suspended, bent, flat iron, have their counterpart

in the beam construction of the Möller system (Fig. 199) used for the construction of bridges of spans up to 20 m. (66 ft.). In this case, the ribs are reinforced on the lower side by suspended, bent, flat irons that are anchored over the points of support, and on which angle iron clips are riveted. The ribs have the fish belly shape, and follow exactly the line of the suspended rods; their depth decreases as they approach the points of support, while the thickness of the floor slab is increased at those points. The floor must take care of the longitudinal pull of the hanging flat irons, and is reinforced at right angles to their length by small I-beams or angle irons.

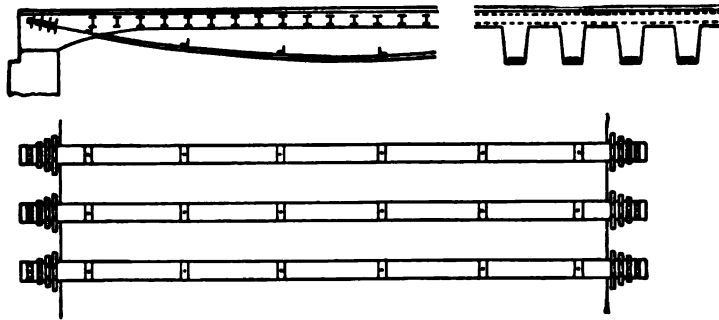

FIG. 199.—T-beam Construction of the Möller System.

The efforts made to manufacture the structural parts of a reinforced concrete structure at a special plant, and then transport them in finished state to the building, have produced a number of floor systems. The most successful in this respect are the hollow beams of the Siegwart system, which form a continuous floor when laid close together, and the beams of the Visintini system* which are used in the same manner, and consist of upper and lower transverse members with connecting webs.

The theory of reinforced concrete construction has undergone many changes. The first suggestions of the prevailing methods of computation as given in the "Leitsätze" are to be found in a communication from Coignet and de Tedesco in 1894, where, for instance, the quadratic equation is given as the means of determining the distance of the neutral layer from the upper surface of the slab. This publication is little known and consequently these formulas were independently discovered by various authors, by Ritter of Zurich, for instance, in 1899, and Emperger. The centroid of compression was also first located in the center of the pressure zone, in place of at two-thirds of its height.

In the first edition of the work of Christophe, "Annale des Travaux publics de Belgique," 1899, the theory to-day contained in the "Leitsätze" is completely discussed, including the provision that the concrete can withstand no tension.

Autenrieth of Stuttgart contributed to Vol. XXXI, 1887, of the Zeitschrift des Vereins Deutscher Ingenieure,† "a graphical method of calculating the anchors which fasten floors to plane surfaces." The methods there set forth are identical with those herein employed for the calculation of reinforced concrete

* Beton und Eisen, No. III, 1903.

† "Berechnung der Anker, welche zur Befestigung von Platten an ebenen Flächen dienen."

work, so that the processes indicated for simple bending and for flexure with axial pressure have been carried over, without change, to reinforced concrete work. This graphical method has been reproduced on page 130 et seq., and it is recommended for use in connection with complicated forms of cross-section.

BUILDINGS

In buildings, reinforced concrete may be used only for floors between steel beams, or in monolithic construction for beams and columns as well.

Reinforced concrete floors between I-beams were formerly constructed as Monier slabs, resting freely on the lower flanges of the beams, or in the form of flat plates carried continuously over the upper flanges. The present customary method of constructing continuous concrete floors between I-beams is shown

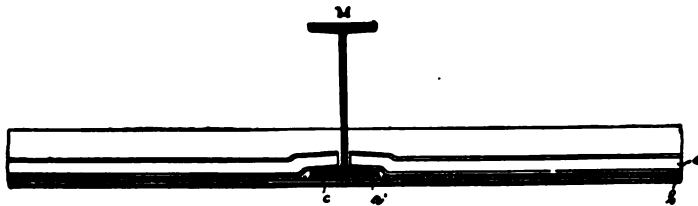

FIG. 200.—Holzer System.

in Fig. 3. The lower flanges of the beams are wrapped with woven wire, so that they will take the ceiling finish which also protects the metal to some extent from the direct effects of fire in case of a conflagration. Among the systems using reinforced concrete between I-beams, the following may be enumerated:

Floors according to the Holzer system (Fig. 200). This belongs to the class of simple reinforced concrete slabs with free ends, and consists of a reinforcement of small beams 22 mm. ($\frac{7}{8}$ in.) deep. The only value of this special form

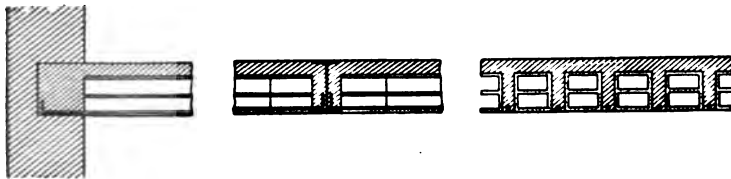

FIG. 201.—Zöllner Cellular Floor.

of section inheres in the possibility of erecting the floors without wooden forms, the small beams not possessing any increased carrying capacity in comparison with round rods of equal size. The support for the concrete is a cane mat, stiffened by round rods and suspended from the I-beams by wires. The mats are thus made to support the load of the floor during construction. The usual spans are from 1.0 m. to a maximum of 2.5 m. (3 to 8 ft. approximately).

The Zöllner cellular floor system (Fig. 201) is suited to wider spans, about 4.5 to 7 m. (15 to 23 ft. approx.). With comparatively small dead weight, it

possesses considerable structural depth, and when set between the lower flanges of I-beams, requires but little filling. The great depth and low weight are obtained by the use of a series of hollow blocks, made from burned clay. The actual supporting structure of the floor consists of T-beams of concrete, arranged side by side, the stems of which carry the reinforcement. Instead of hollow blocks, a light cinder concrete may be used. It is also possible to construct a continuous cellular floor between I-beams or reinforced concrete ribs.*

For sake of completeness there may also be mentioned the Monier arch extensively employed during the early periods of reinforced concrete work, but now replaced by more practical systems. The floor systems designed to be used with reinforced concrete members already in place, are very numerous and their enumeration would be too lengthy.

Monolithic System of Reinforced Concrete. Of far greater importance than the various methods of floor-slab construction between steel beams, are the complete reinforced concrete buildings, in which all the load sustaining parts



FIG. 202.—Warehouse for the Government Railway at Elberfeld in Opliden.

(floors, beams and columns) are executed in reinforced concrete. This material is best adapted for long span, heavily loaded floors, and consequently, advantageously replaces the usual building materials for all factories, warehouses, etc.

All parts are made in situ, so that the entire frame is of a perfectly rigid, monolithic character. The columns are rigidly joined with the beams, and the joint is given additional strength by the haunches under the beams. By this means, even with thin enclosing walls, the stability of the entire structure against lateral forces is considerably increased, as compared with those employing steel beams and columns. In the latter there is always a certain amount of joint-like mobility in the connections. Reinforced concrete beams may be supported directly on the outside walls, when of ordinary masonry, but in order to prevent settlement the walls must have a very solid foundation and should be laid in cement mortar. Or, wall columns may be carried up to receive the floor loads transmitted by

* Beton und Eisen, No. III, 1903.



FIG. 203.—Top Floor of the Speyer Cotton Mill after a Fire.

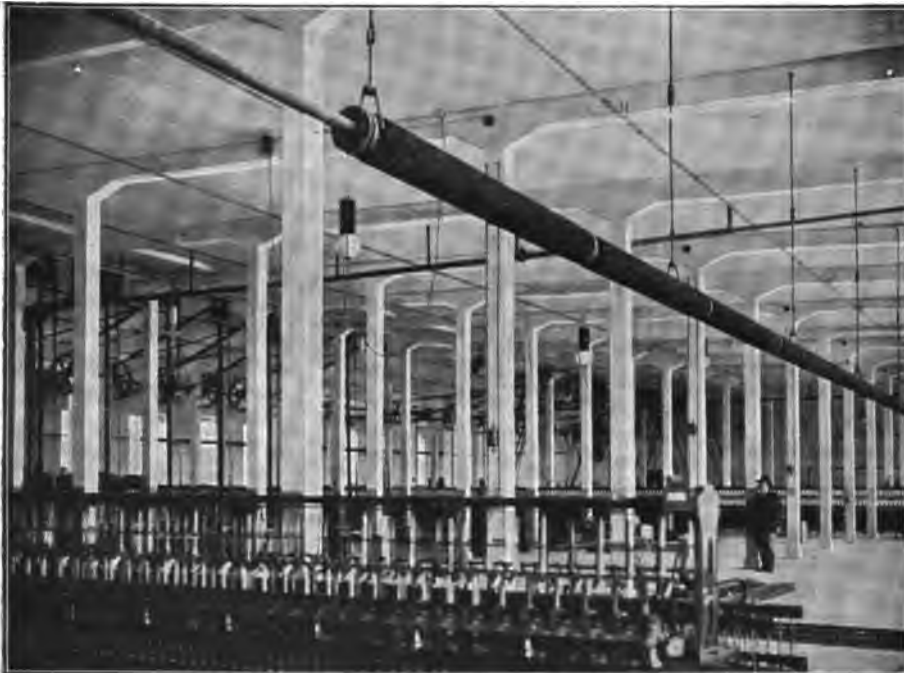

FIG. 204.—Reinforced Concrete Construction of Floors and Columns in the Speyer Cotton Mill on the Rhine.

the main beams. If the wall columns are then connected with special wall beams, which are made to support the floors at the outside walls, the load carrying reinforced concrete frame can be reared by itself, and completed independently of all wall work. When relieved alike of the structural weight of floors and their live loads the masonry of the enclosing walls becomes simply a covering that serves merely to impart to the building the customary appearance. (Fig. 202). But when an outside wall is erected of such a variety, revealing nothing of the particular interior construction, it can be built much lighter than could otherwise be allowed or even than the building laws prescribe. It is then possible, and this is of the greatest importance in factory construction, to leave very large openings for the admission of light. For this purpose, the whole height to the lower edge of the floor slab may be employed, since the ribs of the wall beams and window lintels can be carried above the floors just as well as below them.

The wall columns are subjected to certain bending stresses from the loading of the girders and because of their rigid connection with them, and in consequence are usually carried up of rectangular section, with the long side parallel to the length of the girder.

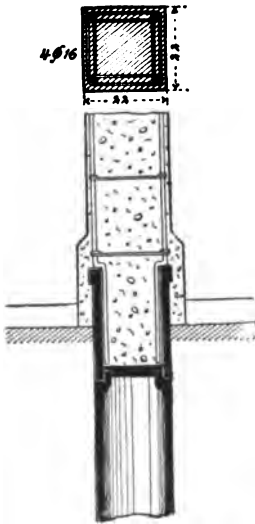

FIG. 205.

For some time, steel columns and beams have not been considered fire-proof building material. Columns bend at 600 to 800° C. (1100 to 1400° F.), while beams break or push apart the outside walls, by their expansion. An instructive picture of the destruction to which a steel structure is exposed in case of a conflagration, is the view shown in Fig. 203, of the upper story of the Speyer woolen factory after a fire.

The interior of the same story, rebuilt in reinforced concrete, is also shown in Fig. 204. The concrete columns stand on the cast iron ones of the lower story, which were spared by the fire (Fig. 205). To insure better insulation and reduce the weight on the old columns as much as possible, the floor slabs were made of pumice-stone concrete, while Rhine gravel was used for the concrete in the beams and columns.

In distinction from steel construction, buildings of reinforced concrete are fire-proof, for in them the metal does not play as important a part, and moreover it is effectively protected from the effects of the fire by the envelope of concrete. Concerning this, the following copy of a testimonial furnishes evidence.

TESTIMONIAL

The Wayss & Freytag Co., are hereby informed that the reinforced concrete construction carried out by them in 1901 in my factory at Neidenfels, consisting of floors, beams and columns, on the occasion of a fire on the 5-6 of Sept. prevented the spread of the flames to the factory rooms on the lower stories.

The floor was found, by a load test made after the fire, to be completely

secure at all points. With the exception of the finish coat on the floor, which was directly exposed to the fire and falling débris, the concrete construction remained absolutely intact.

I can therefore recommend the above mentioned construction to all whom it may concern, as absolutely fire-proof.

(Signed) JULIUS GLATZ.

NEIDENFELS, Sept. 15, 1903.
RHINE PALATINATE.

The foregoing statement of the firm of Julius Glatz, paper manufacturer, Neidenfels, describes the actual circumstances. The load test of a part of the floor in question, with 1800 kg. to the sq. meter (369 lbs/ft²) showed that the reinforced concrete construction, with the exception of the finish coat, had suffered no injury, but remained entirely intact.

THE ROYAL FIRE INSURANCE INSPECTOR.

NEUSTADT-ON-THE-HARDT, Sept. 16, 1903.

Characteristic occurrences of a similar nature, are recorded in "Beton und Eisen," Nos. II and III, 1903. The superiority of the concrete protection of steel beams and columns, as a means of security against fire, compared with the terra cotta employed in America, is also emphasized. The earthquake and subsequent fire in San Francisco left unhurt the concrete protection of beams and columns, while the terra cotta covering fell away because of insufficient anchorage, and allowed the fire free access to the steel work. Concerning entire buildings of reinforced concrete, no experience can be gained, since the local building regulations did not allow the erection of entire structures in reinforced concrete. See "The San Francisco Earthquake and Fire," by Himmel-wight; also "Deutsche Bauzeitung," 1907, No. 28.

As shown in the accompanying illustrations (Figs. 206, 207) of a spinning factory in Finland, hangers for shafting, etc., can be attached at any point to the ceiling, or beams, girders, or columns. As to this point, preference is to be given to a ceiling with beams spaced 2 to 3.5 m. (6.5 to 11.4 ft.) apart, compared with large paneled ceilings carried directly between girders. In the latter case, special stiffening beams must be provided between the columns, and haunches between the floor slabs and the girders are also to be recommended. (See Fig. 207.)

So-called hanging columns may also be advantageously provided for holding shaft hangers, etc. In Fig. 208, showing the interior of the new building erected for the Speyer cotton mills, some of these members are illustrated. Vibration, even with high speed machinery, is hardly perceptible, and it is this freedom from susceptibility to shock and vibration that is one of the great advantages of reinforced concrete edifices. As a rule, the elastic deflection of a reinforced concrete beam can be placed at $\frac{1}{3}$ to $\frac{1}{4}$ that of an equally large steel one. With regard to vibration, however, the great weight in the reinforced-concrete floors and beams, rather than their stiffness, is the determining factor.

The inclosing of the supporting structural members by the erection of façade walls, does not allow of the utilization to the fullest extent of the advantages of

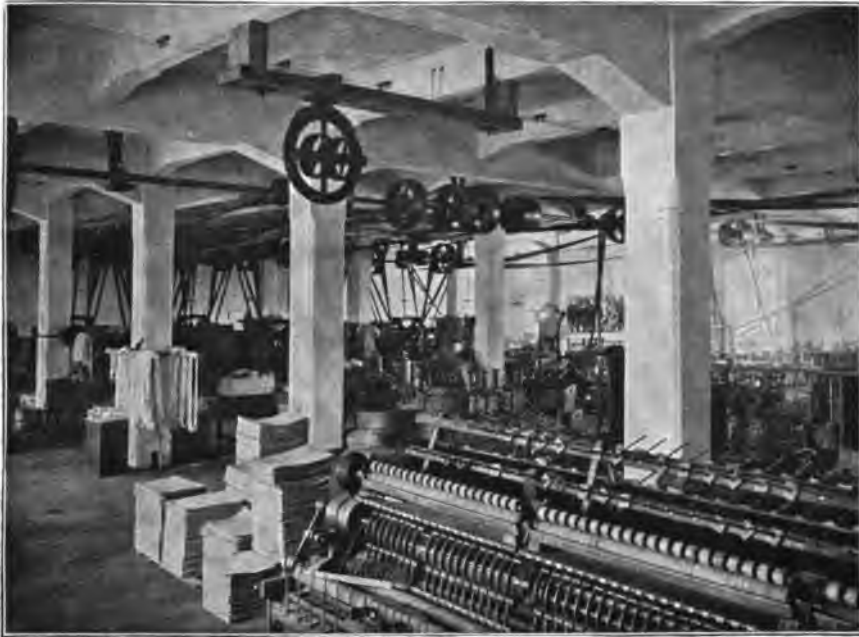

FIG. 206.—Spinning factory in Tammerfors (Finland).



FIG. 207.—Spinning factory in Tammerfors (Finland), haunched floor slabs between girders, stiffening beams between the columns.

reinforced concrete. They are much better realized when the wall-beams and columns are left exposed and the panels thus left are closed with brick or thin concrete filling walls. In such cases, walls only a single brick in thickness on all stories will suffice. In such buildings, the wall beams must be made heavy enough to carry the masonry of the next story above. This consistent utilization of reinforced concrete work is as stable as when complete inclosing walls of masonry are employed, and allows a material saving in masonry work and foundations, permitting the best possible use to be made of the site—an important consideration where the cost of land is as great as in cities. In buildings erected without a cellar, the walls can be carried on transverse arches or reinforced concrete girders, extending between the separate foundations of the wall piers.

An example of this type of construction is shown in Fig. 209, and a complete lay-out is also included, together with details of the reinforcement for the new building of the Daimler motor factory in Unterturkheim.*

Fig. 210 shows a part of the plan of the ground floor and Fig. 211 is a section of the building which has a length of 131 m. (429 ft.) and a breadth of 46 m. (151 ft.). The columns throughout the building are spaced 5×5 meters apart (16.4 ft.), at which distance are also spaced the girders running across the building. Perpendicular to them are the beams, with a spacing of 2.5 m. (8.2 ft.), on which the floors are carried. Over the room on the front of the building are located two rows of girders 10 m. (32.8 ft.) long. In the outer walls all the beams are supported on reinforced concrete columns, and the floor panels are also there carried by beams of the same material, stretching between these wall columns. This arrangement creates rectangular panels in the outside walls, which, because of the great width of the building, are utilized as much as possible for windows. Except the brick curtain under each window, with concrete window sills and a small brick mullion in the center of each panel, no masonry exists in the outside walls. The ribs of the wall beams are not placed beneath the floor slabs as is customary, but are immediately above them, so that the windows extend up to the under side of the floors. (See Fig. 214.) The second floor is provided with a number of openings, corresponding with the roof skylights, which openings are covered with glass and contribute to the better illumination of the ground floor. The concrete wall footings extend in the form of arches between the column foundations. In the front of the building, the intermediate piers are also executed as reinforced concrete columns, because in that case they have to carry the loads of the intermediate beams.

The broken lines in Fig. 210 of the plan indicate expansion joints which traverse the entire structure, including the floors and beams. By them the structure is cut in two longitudinally, and also divided into five parts by four cross joints. These expansion joints, which are absolutely necessary in large buildings to provide against cracks and injurious stresses, were introduced for the first time in this case, as far as known. It is evident the arrangement of such joints does not contribute to the simplification of construction, but rather complicates the design. The joints, which were constructed closed, later opened in part to a width of 6 mm. ($\frac{1}{4}$ in.), thus affording the best proof of their necessity and of

* Deutsche Bauzeitung, Cement Supplement, No. 1, 1904.



FIG. 208.—Hanging columns for the carrying of shafting in the Speyer cotton mill on the Rhine.



FIG. 209.—Office building of Wayss & Freytag, Neustadt-on-the-Hardt.

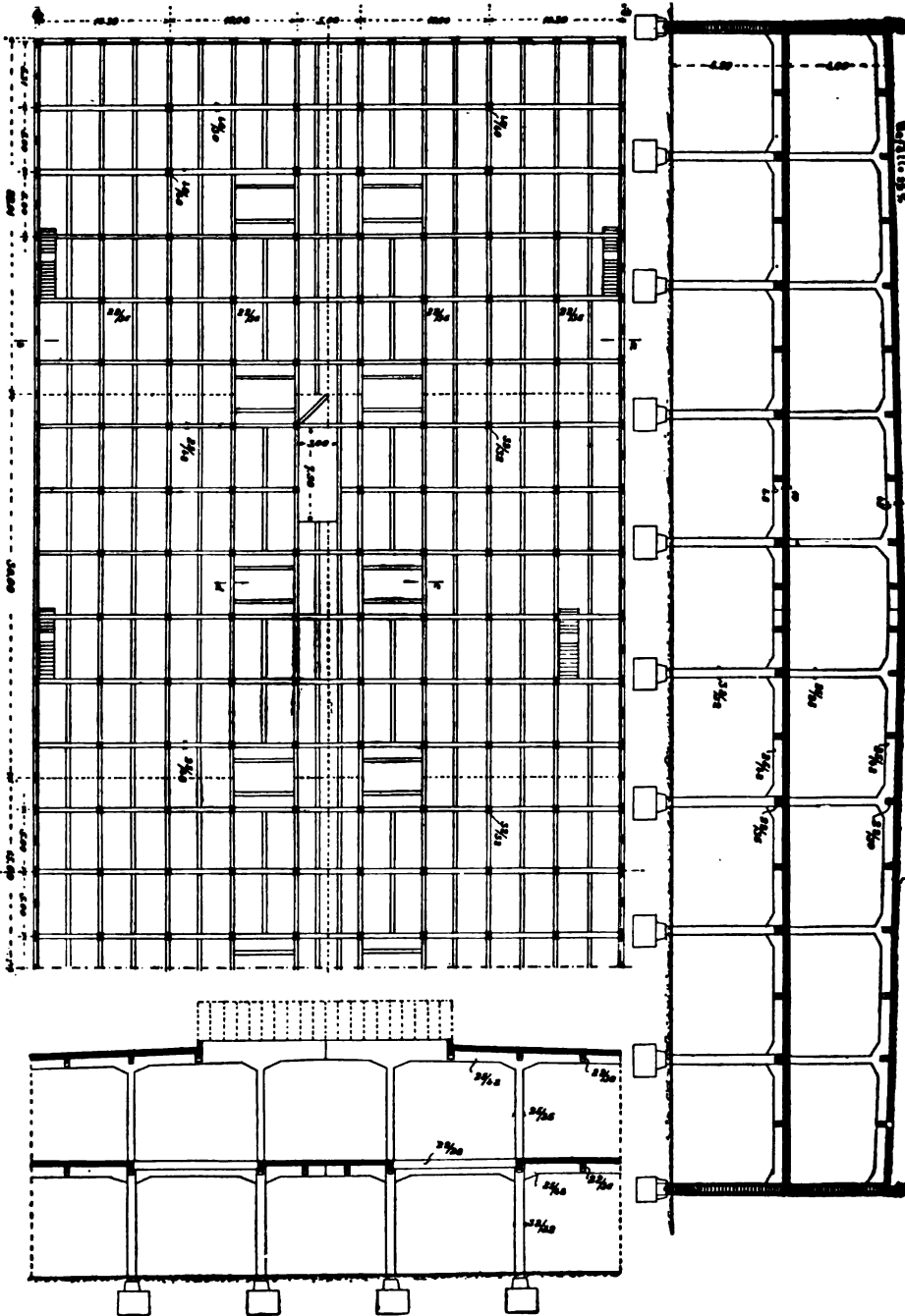

FIG. 210.—Longitudinal section and ground plan.

FIG. 211.—Cross-section.



FIG. 212.—Foundations, Daimler motor factory near Stuttgart.



FIG. 213.—Factory of the Daimler Motor Co. in Unterturkheim near Stuttgart.

their practical value. Because of the joint running longitudinally through the building, the auxiliary beam which would be cut by it, is replaced by two smaller ones, over which the floor slab is cantilevered for 85 cm. (33.5 in.). Next the elevators the expansion joints make necessary the use of beam brackets having an angle less than 45° , and in the roof concrete, ridges with zinc coverings for the joints had to be provided, as shown in Fig. 211.

The roof is covered with pitch strewn with gravel. The wall beams are constructed above the roof level, thus making a gravel stop unnecessary, and

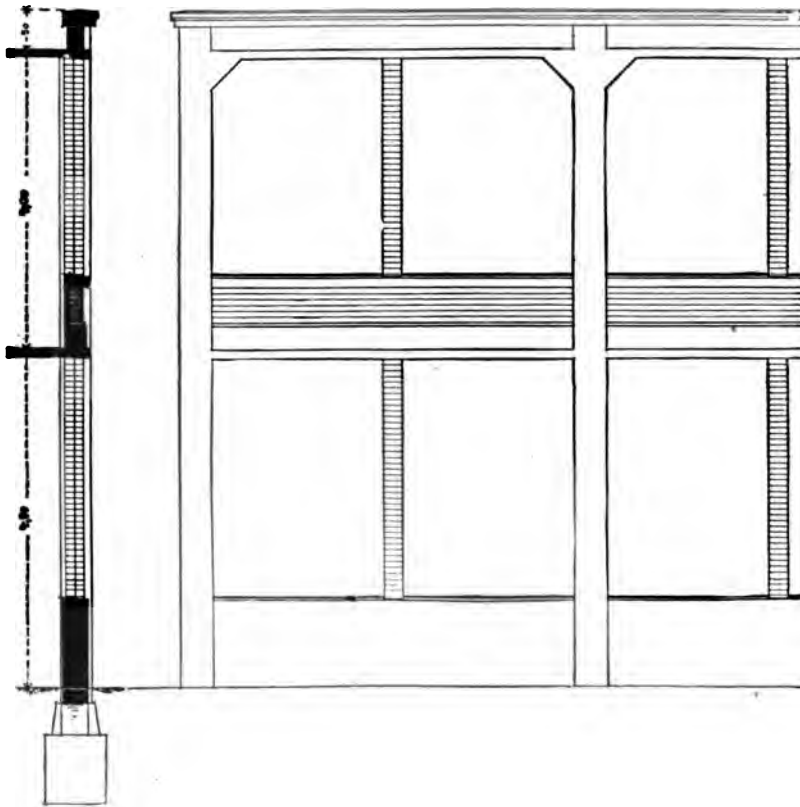
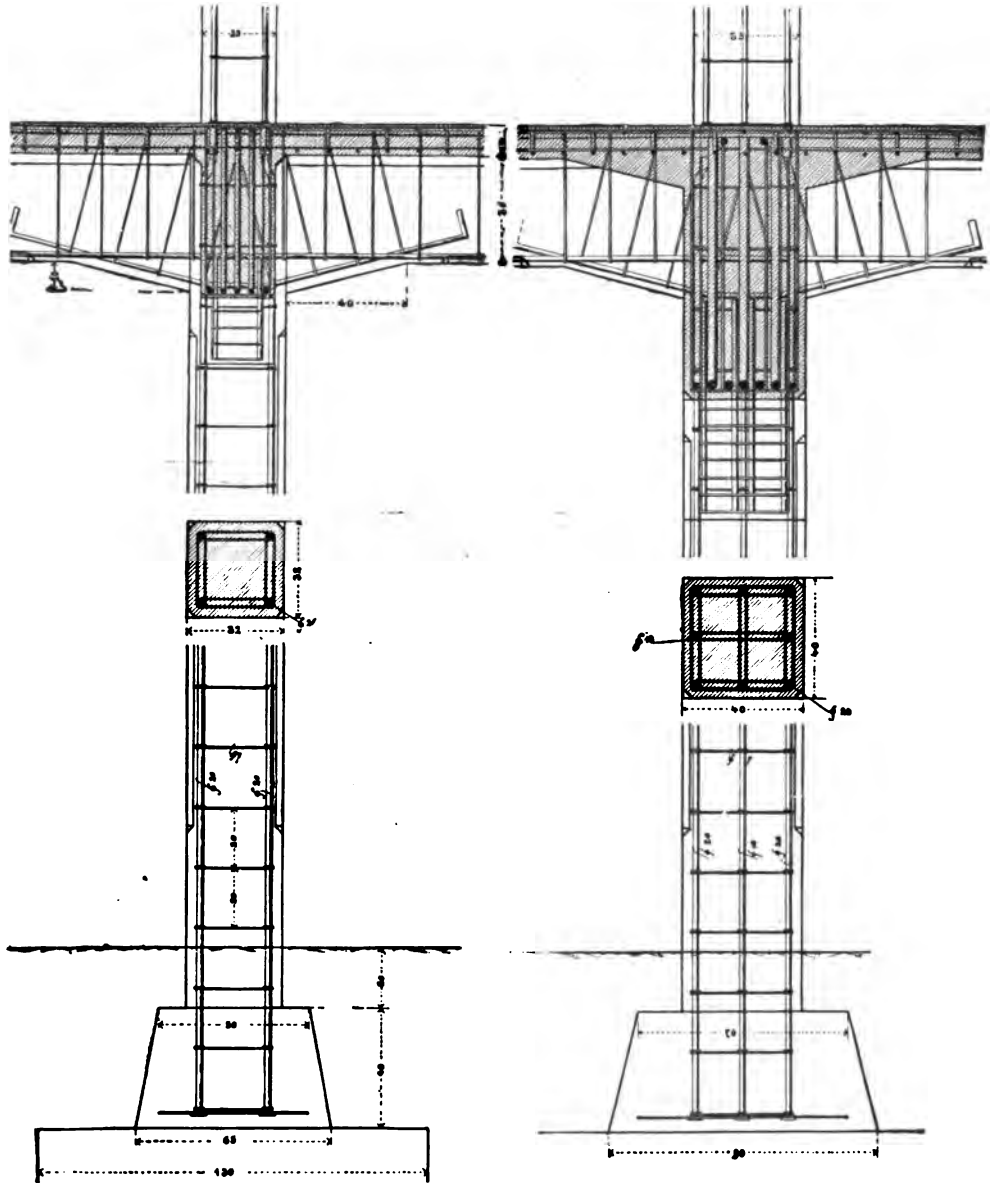

FIG. 214.

are finished with a molding run in cement. The zinc protecting strip engages in a joint under the cornice. From Figs. 215 and 216 may be seen the details of the ground floor columns, together with all their reinforcement. The columns under the girders which are spaced 5 m. (16.4 ft.) apart, have a section of 32×32 cm. (13 in.), with a reinforcement of four round rods, 20 mm. ($\frac{3}{4}$ in. approx.) in diameter, which rest at the bottom on a flat iron grid, and at intervals of 20 cm. (7.9 in.) are connected by 7 mm. ($\frac{5}{16}$ in. approx.) round wire ties. The columns under the girders having the 10 m. (32.8 ft.) spacing, have a section of 40×40 cm. (15.7 in.), and are reinforced with four 20 mm. ($\frac{3}{4}$ in. approx.) round rods at the corners, and four 18 mm. ($\frac{11}{16}$ in. approx.) rods between them.

The section of the wall columns, Fig. 217, was designed with regard to the window openings. The reinforcement consists of six rods, 16 mm. ($\frac{5}{8}$ in.) in diameter.



FIGS. 215 and 216.—Ground floor interior columns.

The live load for the second story was 600 kg/cm^2 (123 lb/ft^2), and in the computations of floors, beams, and girders the most unfavorable distribution of this load had to be taken into consideration. In this connection it was assumed that the floor slabs would rest freely on the beams, that these would be supported

freely on the girders, and that the latter would rest freely on the columns. Thus, all these structural members would be continuous beams with a larger or smaller number of spans, and with cantilever ends because of the presence of the transverse expansion joints.

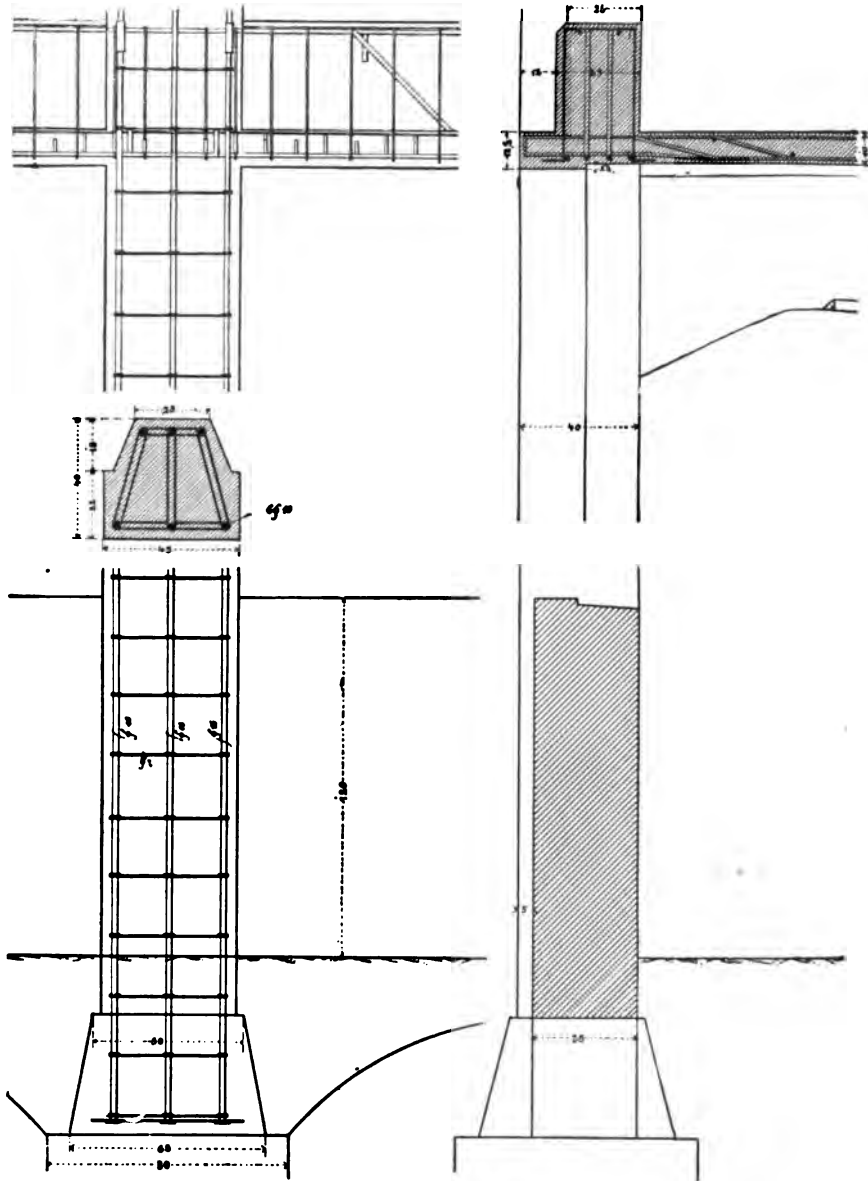
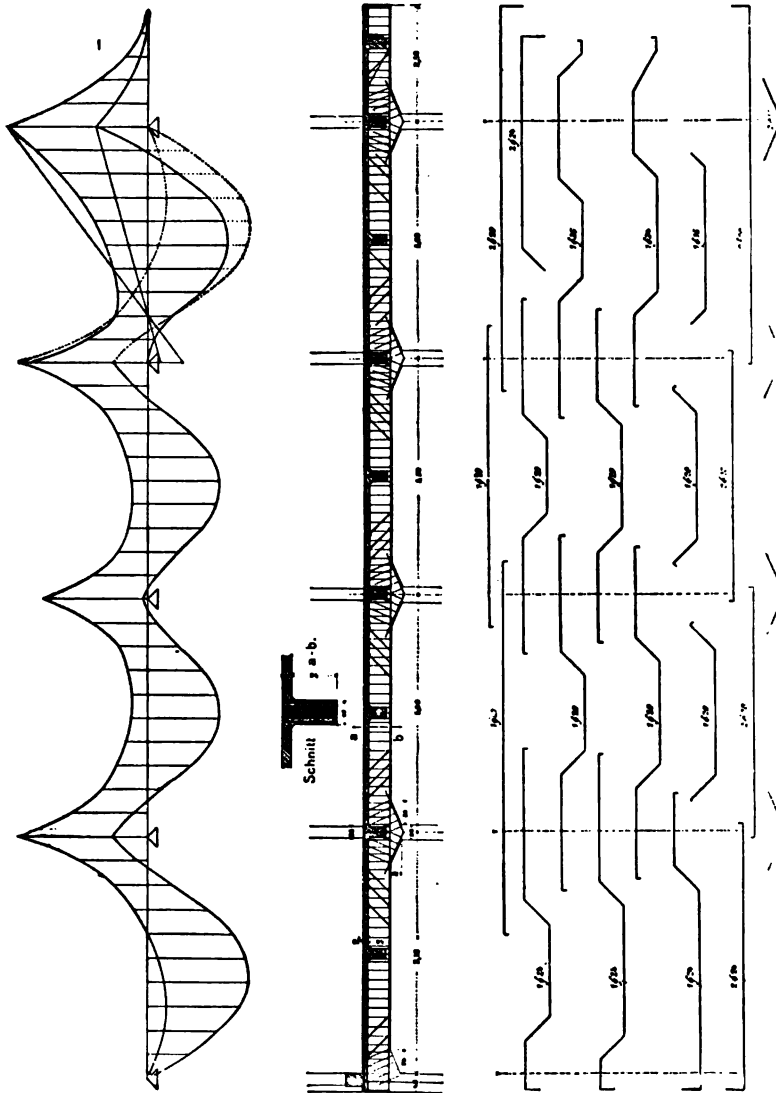

FIG. 217.—Ground floor wall columns.

In Fig. 218 are shown the positive and negative moment curves for a girder of four spans with free ends. They were calculated according to the tabular values given by Winkler, and the influence of the end spans is only considered

with reference to the adjoining intermediate ones. The necessary reinforcement at top and bottom was determined on the basis of these maximum curves, and was constructed as shown in Fig. 219. The necessary section of reinforcement at the top over the supports, was provided by long overlaps of the bent lower bars.



FIGS. 218 and 219.—Maximum moment lines and reinforcement of girders.

This condition cannot be obtained from the small overlaps employed in certain "systems." In the computations, the restraint of the beams at the walls was ignored, but since a part of the lower reinforcement was bent upward to care for the shearing forces, a partial restraint was created by this top reinforcement and its anchorage in the wall columns.

The girders join the columns, and the beams join the girders with haunches, so that the allowable compressive stress of the concrete on the lower surface of

the beam may not be exceeded at those points. The two round rods 18 mm. ($\frac{11}{16}$ in. approx.) in diameter which pass through the columns, and are carried into the girders on each side, serve the same purpose. The reinforcement of the beams and the floor slabs was carried out on the same principle. The latter is shown in Fig. 220. In Fig. 221 the details are shown of the connection of the two intermediate beams with the wall beams.

The 25 cm. (10 in. approx.) brick curtain walls originally planned were replaced by reinforced concrete ones, 8 cm. (3 in. approx.) thick, which were considered equal in fire-proof quality to the brick curtains.

The construction was completed in three months, the daily rate for floors and beams being about 500 m² (5381 ft²).

This structure is considered a typical example, in which all the advantages of concrete construction were secured, so that its economic benefits were also obtained. The short period of

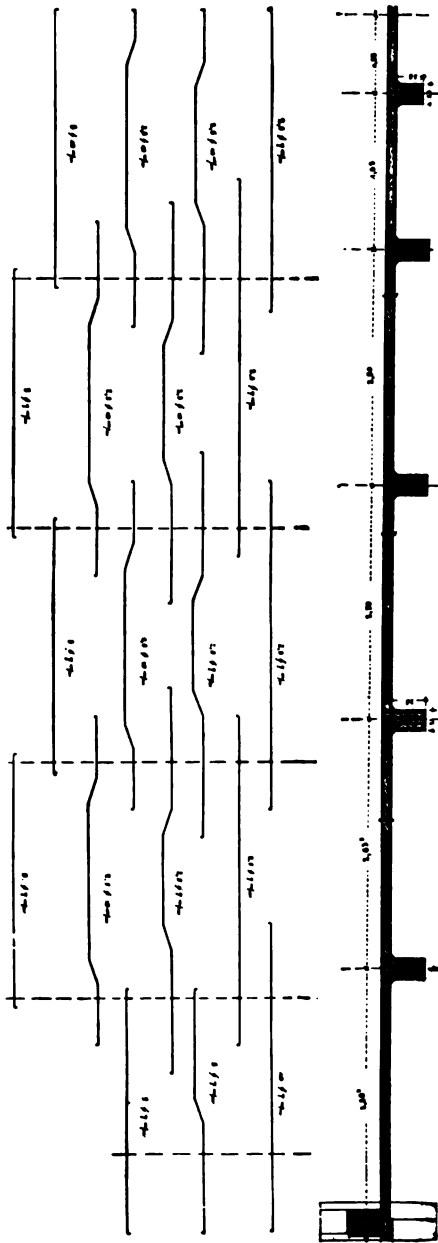

FIG. 220.—Reinforcement of floors.

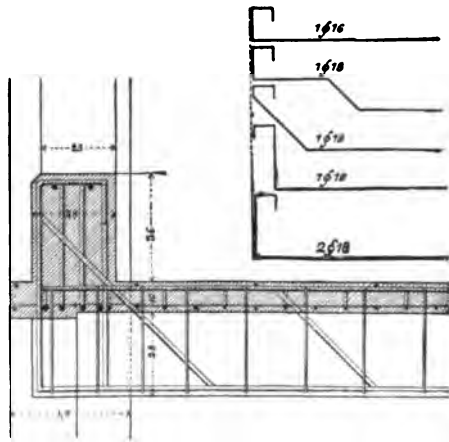

FIG. 221.

erection shows that with the necessary trained staff and the required equipment, reinforced concrete buildings may be erected with a speed of which no other type of building admits.

Figs. 222 and 223 show examples of the tasteful interior treatment of the Tietz Shop on the Bahnhofplatz in Munich (Heilmann and Littmann, architects). The same rectangular reinforced concrete panel was employed on all floors. The doubly reinforced slabs with spans of 5.15 m. (16.9 ft.) in both directions had haunches on all four sides at the beams, which were all of equal size. In the center of the building rose a large light shaft of elliptical section. The illustrations show the completed decorative interior in reinforced concrete, the light shaft with stairways and the counter space. An extremely simple architectural treatment of the interior of the building was intended. The entire under sides



FIG. 222.—Interior view of the Tietz shop in München.

of the floors and beam bottoms with their light moldings were made white, down to the two brown lines around the tops of the columns, making a very simple decorative treatment of the interior of the salesrooms. The reinforced concrete columns and parapets around the light well were covered with tasteful marble panels in different colors, and decorated with colored mosaic glass tile.

Fig. 224 shows the placing of the reinforcement.

The double reinforcement of the floor slabs was done with a beam spacing of 6.5×6.5 m. (21.3 ft.). It is possible, however, to divide the panels produced by a square column spacing into smaller squares by beams crossing each other, reinforcing the slabs as square panels partially restrained at the supports. Such an arrangement is shown in Fig. 225. The beams then rest freely on the enclosing walls.



FIG. 223.—Light well in the Tietz shop in Munich.



FIG. 224.—Placing reinforcement for Tietz shop.

Fig. 227 shows the floors of the immense Deimhardt wine cellar during construction in Coblenz. Since only a small height could be employed for the



FIG. 225.—Storehouse in Ulm. Square floor panels and intersecting floor beams.

structure, and at the same time large spans and considerable live loads (1000 and 1500 kg/m²—200 and 300 lbs/ft²) were required, intermediate beams were necessarily omitted and the floor panels were given a width of 6.1 m. (20 ft.) between



FIG. 226.—Printing house in Heibronn.

girders. Because of the small head room, it was necessary to make the latter very wide.

The floors were constructed according to the Zöllner cellular system, in which gutters were placed throughout the central parts of the panels.



FIG. 227.—Erection of the three-story Deinhardt wine cellar, Coblenz.

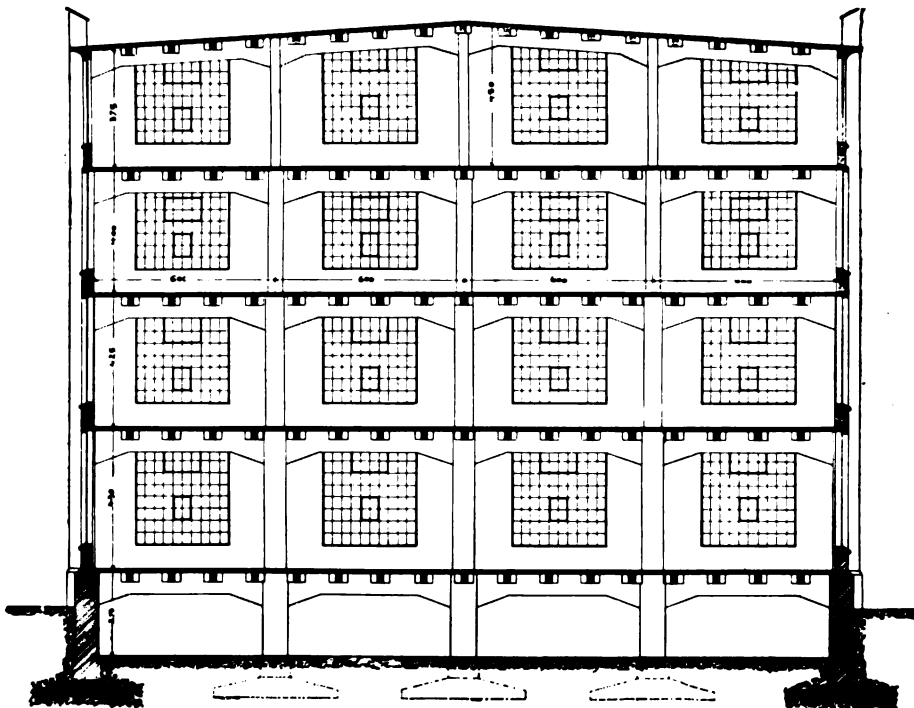

FIG. 228.—Cross-section of the Singer Manufacturing Co. factory in Wittenberg,

There may also be mentioned the immense factory now in course of construction for the Singer Manufacturing Co., in Wittenberg, near Hamburg. It covers



FIG. 229.—View of a floor in the Singer Manufacturing Co. factory showing widening of the beams where they intersect the girders. Columns of béton fretté.



FIG. 230—Krefeld warehouse, with flat roof and monitor skylights.

an area of over 5000 m² (54,000 ft² approx.) while the whole building with its four floors affords a working space of about 20,000 m² (240,000 ft² approx.). The



FIG. 231.—Composing room of the “Münchener Neuesten Nachrichten.”



FIG. 232.—Reinforced concrete roof supports in the building of the “Münchener Neuesten Nachrichten.”



FIG. 233.—Loft of the forge shop of the Daimler motor factory.

floors, which had to carry a heavy live load, could have only shallow intermediate beams, because of the power transmission requirements, and for the same reasons they could not be very deep at the girders. The heavy compressive stresses on the undersides were reduced by widening the beams in accordance with calculations. (Figs. 228, 229.) The columns in this building were reinforced with spirals.

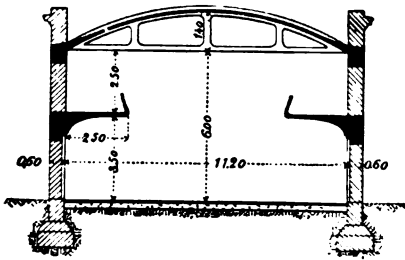

FIG. 234.—Hall in Pfersee.

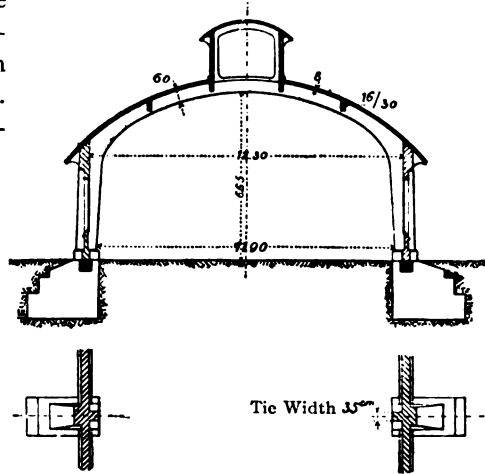

FIG. 235.—Locomotive house in Haben Krefeld.

The roof covering best adapted for reinforced concrete is of tar, laid with a grade of $2\frac{1}{2}\%$. The 10 cm. (4 in. approx.) layer of gravel on such a roof, in most



FIG. 236.—Interior view of locomotive house in Krefeld.

cases provides sufficient insulation against changes of temperature. A roof covering with a double layer of felt is also employed, and has the advantage of lower cost, and allows a steeper pitch, up to about $15\frac{5}{6}\%$. Sheet zinc is attacked by the cement concrete, and requires an intermediate layer of roofing paper. In buildings of large area, some roof panels may be omitted, and subsequently covered with monitor skylights. (See Fig. 230.) For architectural or other reasons, high pitched roofs are also constructed. They may be covered with sheet metal or tile. (See Fig. 231.) Roofs are also constructed with long span girders. Fig. 234 shows the roof of a hall in Pfersee, with girders in the form of braced arches, while Figs. 235-237 show a locomotive roundhouse at Hafen Krefeld,



FIG. 237.—Exterior view of locomotive house in Krefeld.

in which the girders are in the form of arched beams. The design of the latter can be done through consideration of the elastic conditions produced by live load, and snow and wind pressures.

The forms for the floors of reinforced concrete buildings several stories in height, are best so arranged that the side pieces of the beams form can be removed after the concrete has hardened sufficiently, whereas the supports and bottom pieces should be allowed to remain for a longer period (4 to 6 weeks). To facilitate the removal of the forms, all the supports rest on wedges. In determining the period for removing the forms, besides the weather conditions during the period of setting, the question has to be considered as to whether the floor in question has to carry the forms for the stories above it.

Spirally reinforced concrete is especially applicable to the columns of high

buildings. Above all, its usefulness is disclosed where heavily loaded columns would require large diameters, such as those shown in Fig. 229 in the new building for the Singer Co., which are supplied with spirals. They were wound on hollow cylinders, with the coils close together, and could then be easily stretched longitudinally until the required pitch was secured. The last half-turn of the spiral should overlap, and the end of the rod be made into a hook carried to the center of the coil. Fig. 238 shows the steel skeleton of such a column.

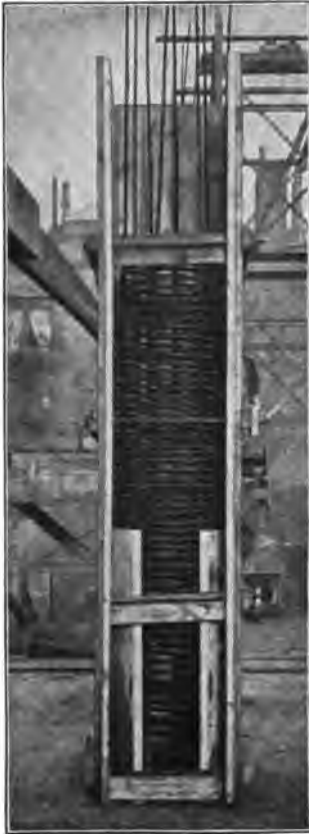

FIG. 238.—Steel skeleton of a spirally reinforced column.

STAIRS

Reinforced concrete stairs may be variously applied. In Fig. 239 is shown a staircase built according to the old method after the Monier system; the flights being supported by flat arches, braced against the structural parts of the landings. The steps are of concrete. Winding staircases in residences (Fig. 240) may also be erected in reinforced concrete, by arranging as the carrying structure, a winding slab of reinforced concrete from 10 to 14 cm. (4 to 6 in. approx.) thick, supported in slots, 6 to 10 cm. ($2\frac{1}{2}$ to 4 in. approx.) deep, cut in the masonry, on which slab the steps are formed. Winding stairs with side strings are also practical, as shown in Fig. 241.

Stairs with straight flights can be arranged in different ways, according to conditions. Thus, Fig. 242 shows a stairway of reinforced concrete, in which, for lack of other support, the landing is suspended from the reinforced concrete beam overhead; while, in Fig. 243, an arrangement is exhibited in which brackets of reinforced concrete are employed, which bisect the angle of the inclosing walls, each forming an integral part of one tread, thus carrying the flights.

Artificial stone stairs can also be constructed of concrete, each separate step forming a reinforced concrete beam, molded in advance, and set in place after having sufficient time to harden. Both ends may be supported, or in the case of flying staircases, one end may be set in a wall.

Properly constructed stairways of reinforced concrete are just as safe as other parts. This cannot always be said of stairways built of stone or wood, in accordance with usual methods. In regard to security against fire, reinforced concrete stairs are superior not only to those of wood or stone, but also to those of iron. The little dependence which can be placed on stairs built of limestone is shown in an illustration in "Beton und Eisen," No. II, 1903, p. 79.

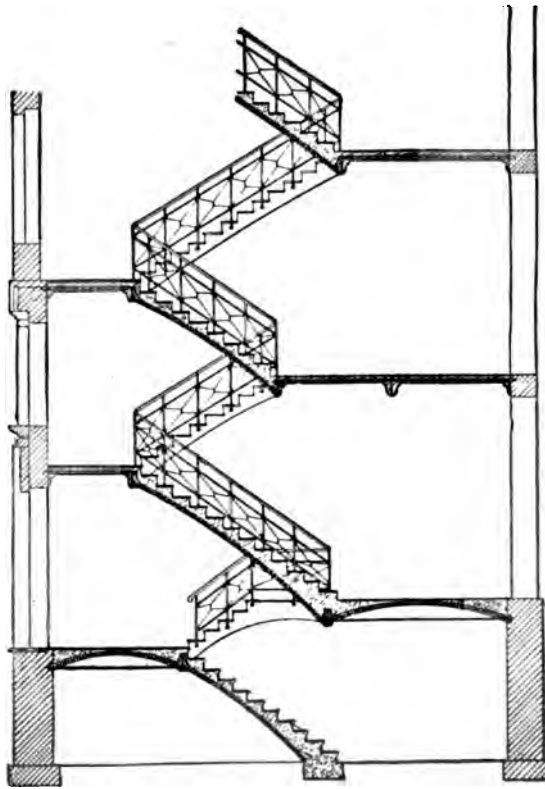

FIG. 239—Old arrangement of stairs with Monier arches under the flights and platforms.



FIG. 240.—Winding reinforced concrete staircase without side strings in the Handel School in Landau.



FIG. 241—Stair construction in the Hotel "Rotes Haus" in Strassburg.

The treads of reinforced concrete stairs can be finished with any desired covering, such as linoleum, oak, etc., so that they are adapted to the highest requirements. .



FIG. 242.—Reinforced concrete stairs with suspended platforms in the brewery in the English Garden in Stuttgart.



FIG 243 —Reinforced concrete stairs in the storehouse of the National Railway, Elberfeld in Opladen.

ARCHES IN BUILDINGS

The arches which occur in buildings may serve the most varied ends. If they are merely decorative in character, they may be executed as thin "Monier" arches, without forms, with woven wire on an iron framework. They are then more easily carried and more durable than when built of "Rabitz"* construction.

By employing heavier T and L iron framing, larger openings may be spanned without forms. This method has been employed for numerous vaulted church roofs, as shown in Fig. 245. The framing iron is there located within the arch ribs.

In distinction from this may be mentioned the work shown in Fig. 246, of the vaulted ceiling of St. Joseph's Church in Würzburg, for which the arch ribs, with a span of 20 m (65.6 ft.) were rammed in wooden forms and reinforced with round rods.

In order to give the ribs the same appearance as the work below the spring of the arches, which was composed of genuine shell limestone, crushed stone, and grit for the concrete, was prepared from the same material, and the ribs afterwards dressed by a stone cutter. The appearance of these arches fully met all requirements. The inverts between the ribs were made after the Holzer patents, small framing irons being employed and giving excellent results. The advantages of this type of arch are its security against cracking and its stability compared with a stone structure. In case of fire, such a vault will withstand the fall of the burned roof with perfect safety, and thus it forms an important protection for the interior of the church. Manifestly all such barrel or groined arches can be constructed wholly on forms.

Fig. 247 shows a fire-proof arrangement of a continuous barrel arch with transverse openings over the gymnasium of a school house in Munich.

Among other uses of the reinforced concrete arch in building work may be mentioned an arch in which the profile which is required for architectural reasons, does not conform to that necessary from a statical point of view. Only in reinforced concrete can such structures be executed—an example being shown in Fig. 249—since tensile stresses can then be cared for and the line of pressure need not necessarily be located within the middle third.

Reinforced concrete is particularly well adapted for the construction of domes. Through variation in the number and size of the reinforcing members placed in meridional and parallel circles, it is possible to provide for all possible stresses. Since reinforced concrete will resist tensile stresses, almost any surface of revolution can be used as the dome. Around its base a tension ring, preferably of channel section, resists all the horizontal components of the meridional stresses, so that the interior is entirely free from structural parts. If the crown of the dome is to be broken, so as to admit a skylight or cupola, the meridional compressive stresses can be resisted by a concrete pressure ring with reinforcement.

Domes (6 to 12 cm. thick—2.4 to 4.7 in.) can be erected with the help of forms

* Cement mortar on wire lath.—(TRANS.)



FIG. 244.—Hall of Justice in Landau. Decorative "Monier" arches.



FIG. 245.—Groined arches of reinforced concrete in the monastery chapel in Landau.



FIG. 246.—Arches in St. Joseph's Church in Würzburg.



FIG. 247.—Fireproof Monier arches over the gynasium of the school in the Gatzingerplatz, Munich.

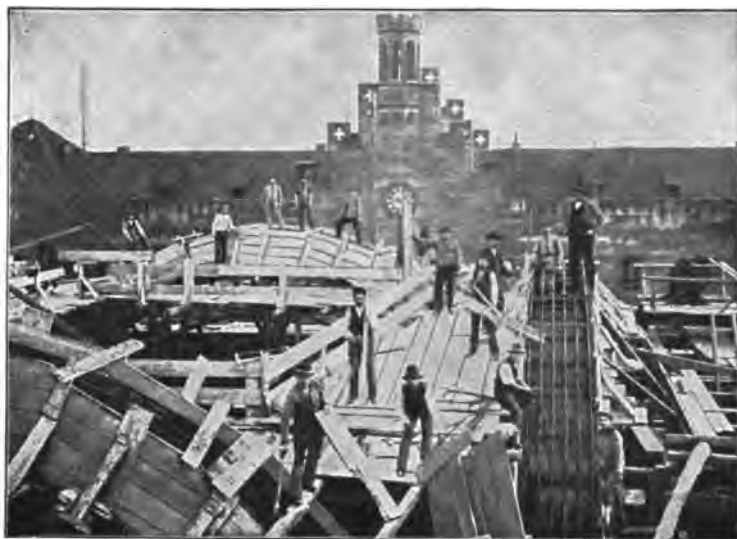

FIG. 248—Semi-circular arches in the reconstructed railroad station in Nürnberg.



FIG. 249—Reinforced concrete semi-circular arches in the cupola of the new station in Nürnberg.

or with shaping members in the directions of the meridinal and parallel circles, the trapezoidal spaces between irons being covered with woven wire, held in place by wires run through holes in the frames. The concrete is then made to



FIG. 250—Reinforced concrete cupola and lantern of the Army Museum in München, diameter 36 m. (52.5 ft.).

cover the whole of the metal. The design of domes is best done graphically, just as in domes of the Schwedler type.

Figs. 250-253 show a reinforced concrete dome of the Army Museum in Munich.

In Fig. 250 is shown the exterior view of the whole dome. Including the

9 m. (30 ft.) high lantern with its spire, the total height above grade is 57 m. (187 ft.).

Fig. 253 is a plan of the dome, and in Fig. 252 a section is shown. Fig. 251 shows, at a larger scale, the support for the base of the dome. As there shown, both inner and outer shells were provided. The first, of a radius of 8.1 m. (26.6 ft.), carries only its own weight and is supported about 1 m. (3.3 ft.) lower than the outer dome, the surface of which is generated by radii of varying size. Each dome is supported on a footing ring, consisting of a D.N.P.* 14 cm. (5.5 in.) channel, set in the tambour, which had a thickness of from 38 to 51 cm. (15 to 20 in.). The concrete was from 5 to 6 cm. (2 to 2.4 in.) thick, and was strengthened by reinforcement arranged in the directions of the meridional and parallel circles. In the outer dome the upper compression ring is made of an angle $50 \times 50 \times 7$ mm. ($2 \times 2 \times \frac{5}{16}$ in. approx.), the ring upon which the lantern 4 m. (13.1 ft.) in diameter rests, is a D.N.P. 12×6 cm. T (4.7×2.4 in.), while the remaining parallel circles are 8×4 cm. T's, (3.1×1.6 in.) and the meridians

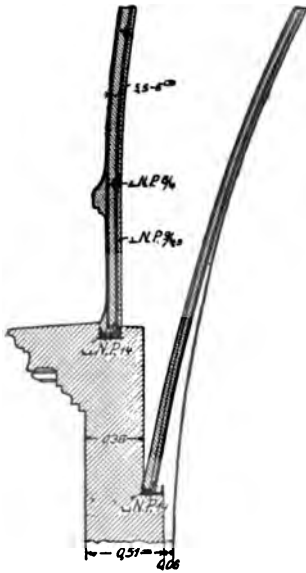

FIG. 251.—Detail of base of cupola.

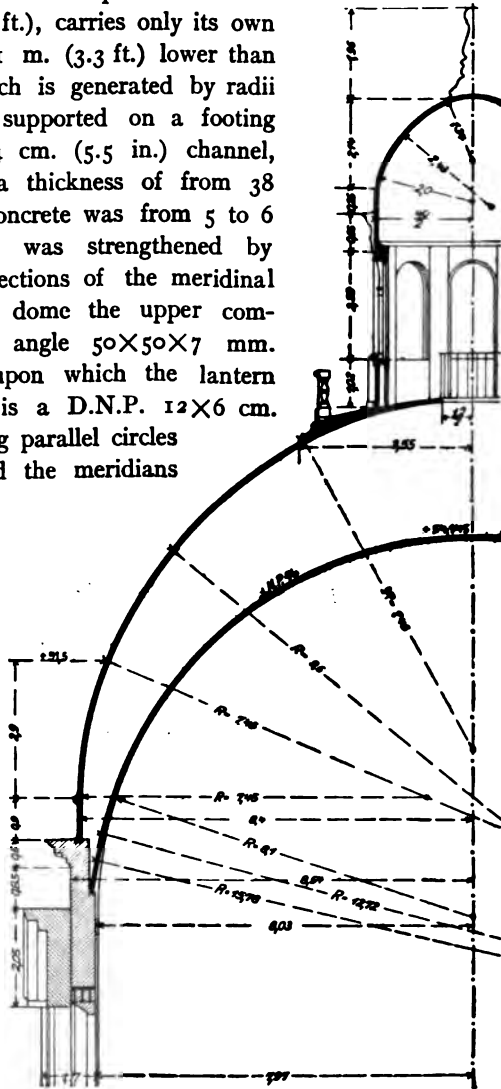

FIG. 252.—Vertical section through the cupola of the Army Museum in Munich.

are 9×4.5 cm. T's (3.5×1.8 in.). Between the meridional and ring members was placed a 7 mm. ($\frac{5}{16}$ in. approx.) round wire grid, with 10 cm. (3.9 in.) meshes. The inner dome is covered only with mortar on the outer side, the

* German standard.—(TRANS.)

outer dome being covered with copper, fastened to wooden plugs which were placed in the dome along with the concrete. The copper is separated from the concrete by a coat of asphalt.

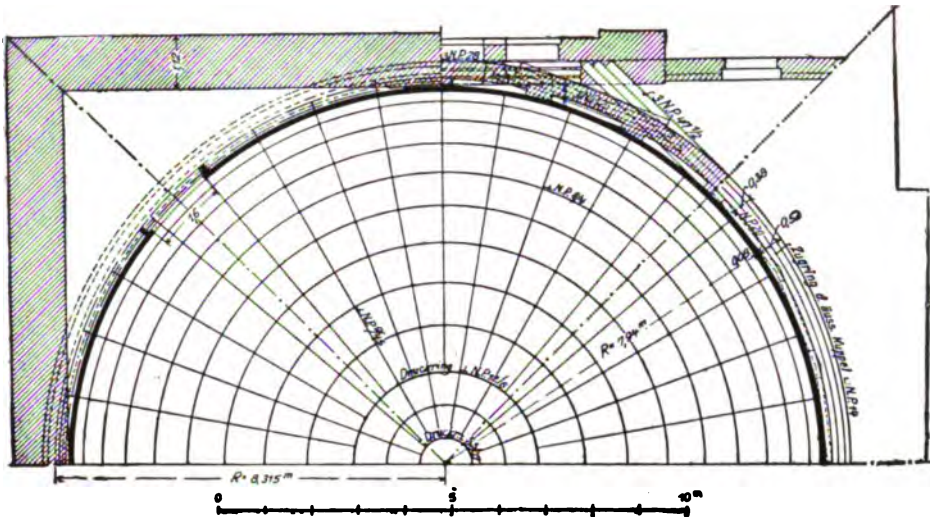

FIG. 253.—Plan of cupola of the Army Museum.

SPREAD FOOTINGS

To prevent bad settlements, the areas of the foundations of a building must be proportioned to the carrying capacity of the soil. If the carrying capacity is small, a very large bearing area is required, which can be secured by the use of reinforced slabs possessing the necessary bending strength. In this way it is possible to reduce the pressure on the soil to 0.5 kg/cm^2 (0.5 tons/ft^2) or less, so that poor building areas and filled ground can be used for the foundations.

Fig. 254 shows the bottom of a sewer in Wiesbaden, with footings 8 m. (26 ft.) deep. Since the soil could not be loaded more than 1.5 kg/cm^2 (1.5 tons/ft^2), the entire space between walls had to be called upon to resist the pressure. This was accomplished by the construction of a foundation slab, 45 cm. (17.7 in.) thick, extending from one wall to the other. Considered statically, the slab constituted a beam supported at both ends, and bent by the upward earth pressure. The reinforcement required per meter length of sewer was 10 rods 24 mm. ($1\frac{5}{8}$ in.) in diameter, which, because of the curvature of the surface, had to be anchored into the concrete by means of stirrups 7 mm. ($\frac{5}{8}$ in. approx.) thick. As a sub-base for the sewer, a 15 cm. (6 in. approx.) layer of stone was laid in cement mortar.

Spread footings should be employed when, for any reason, piling is impracticable. In many instances, such footings are cheaper than piling.

Fig. 255 shows a usual form of reinforced concrete footing, under a row of silo columns. In this instance it was necessary to distribute the concentrated column load uniformly longitudinally as well as laterally, and consequently

reinforcement was needed in both directions. The longitudinal reinforcement served to distribute the concentrated loads over the space between the columns.

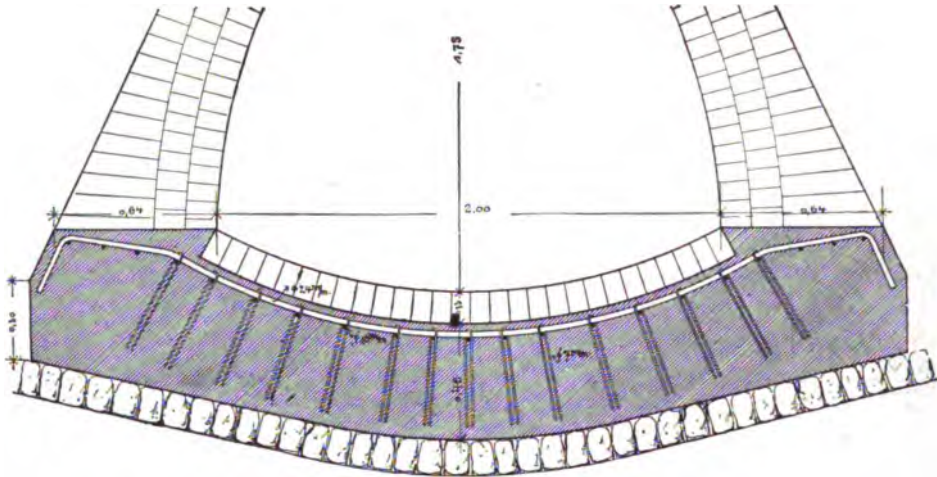

FIG. 254.—Reinforced concrete sewer base in Wiesbaden.

Walls of buildings can be founded on reinforced concrete footings. For this purpose slabs of necessary width should be constructed along the line of the wall, projecting equally on both sides, as shown in Fig. 255. Such footings do not,

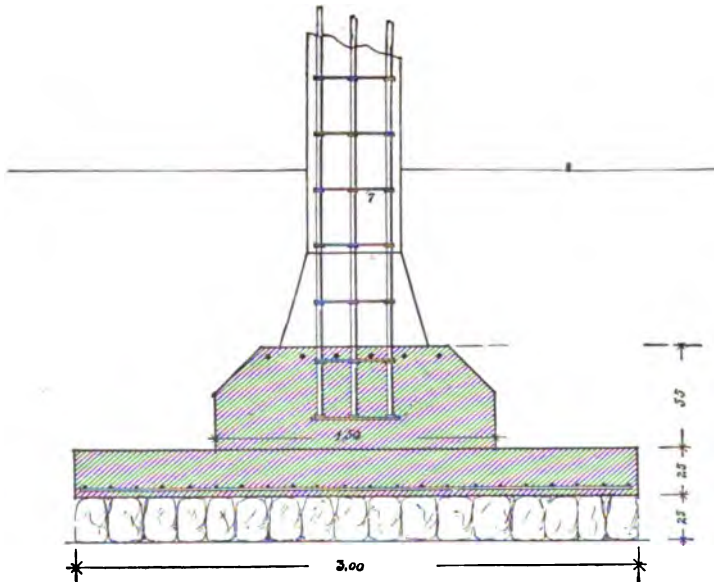

FIG. 255.—Silo column foundation.

however, distribute the load uniformly if eccentrically located with respect to the wall, as sometimes happens when the wall is built flush with the property line. In such a case a slab is required which extends under the whole building, or a

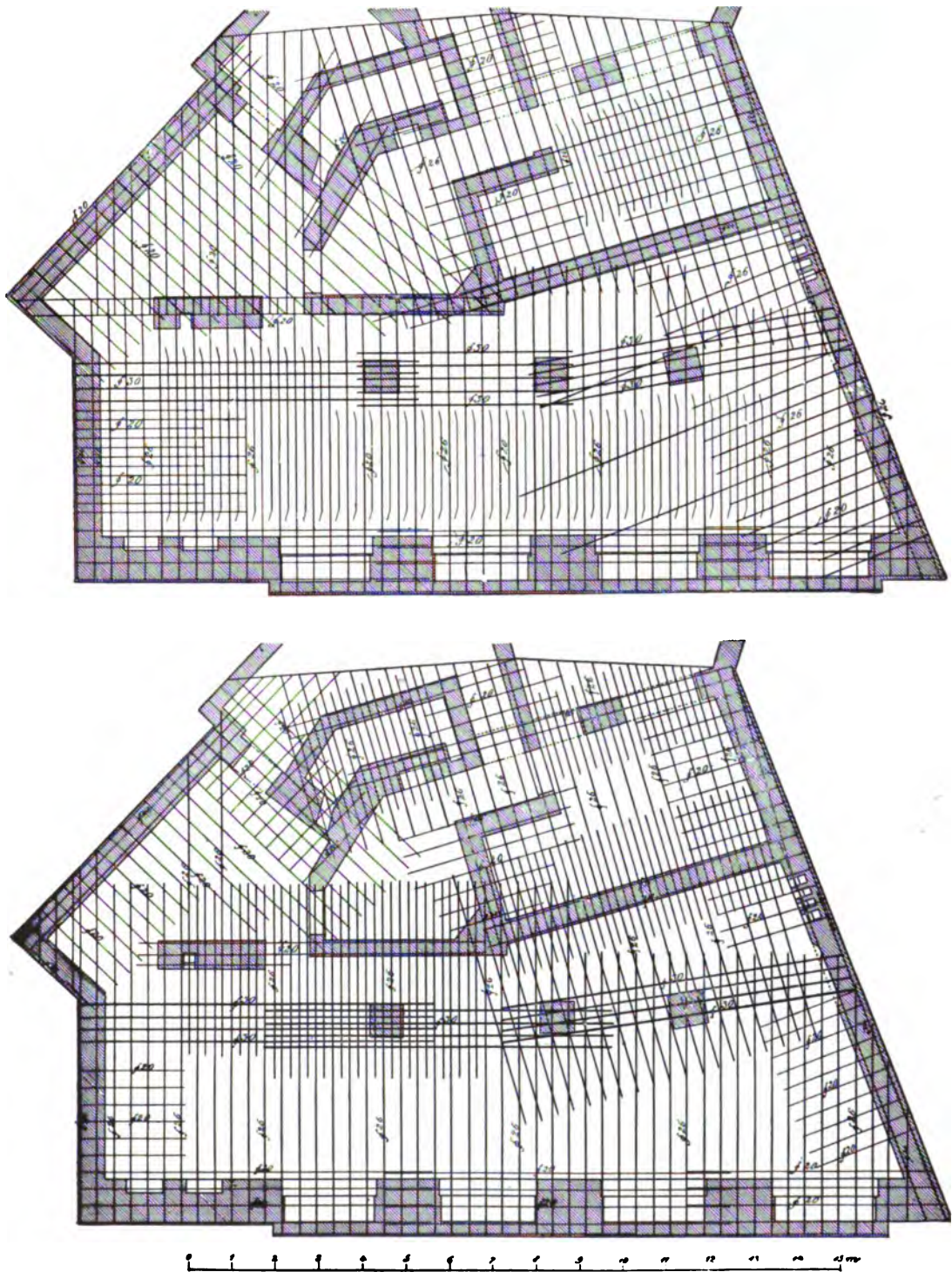

FIG. 256.—Foundation slab, 50 cm. (20 in. approx.) thick, under a business building.

large part of it. If the centroid of the slab coincides with that of the building load, it is possible to distribute the load uniformly over the site, by means of a reinforced concrete foundation.

In Fig. 256 is shown the upper and lower reinforcement of a footing slab, 50 cm. (20 in.) thick under a business block in Stuttgart. Upon the assumption of a uniform earth pressure of 0.7 kg/cm^2 (0.7 tons/ft^2) it was possible to compute approximately the positive and negative moments of the various panels and to arrange the reinforcement accordingly. Between the piers a stronger reinforcement is provided, so that the slab will act as a beam to distribute the concentrated load uniformly over its entire length, and transmit it to the line of reinforcement running perpendicular to the heavier material. At distances of about 50×50 cm. (20×20 in. approx.) the upper and lower reinforcement was tied together with stirrups. Similar footings as much as 75 cm. (30 in. approx.) thick were constructed by Wayss and Freytag for the large Elbhof block in Hamburg, and for various large silos.

As a rule, in complicated ground plans, the statical relations are not entirely clear, so that calculations are made on somewhat unfavorable assumptions, and a certain excess of reinforcement should be employed. Sometimes the computations cannot be based on a uniform soil pressure. In such cases the resultant of all the loads does not coincide with the centroid of the ground plan, or some of the loads are much heavier than others. Then varying pressures are to be reckoned under the several parts.

Foundation slabs constructed in this manner permit of a saving of excavation, require less material, and solve the problem better than when the usual heavy concrete footings are employed, reinforced with grillages of rails or I-beams. They are adapted to the foundations of buildings, chimneys, fountains with heavy superstructures, monuments, etc., which are to be set on light soils.

SUNKEN WELL CASINGS

Sunken well casings of reinforced concrete were constructed according to the Monier system at an early period of its development. They serve either for obtaining water, in which case they are provided with holes in the walls, or as foundations for buildings, bridge piers, etc., and must be filled with concrete after being sunk. Compared with masonry well casings, they are capable of resisting heavier external pressures, and on account of the thinness of their walls they easily penetrate the soil, but their relatively lighter weight makes necessary a greater artificial load.

Fig. 257 shows such a well being sunk by hand dredging for the municipal plant of Bamberg. The top is constructed in the shape of a dome.

In Fig. 258 are shown the piers for the Kocher Bridge at Bröckingen, erected on such sunken wells, details of reinforcement being also given. The casings, with a clear width of 1.5 m. (5 ft. approx.) or less, were constructed as reinforced concrete pipes, those of the larger diameter being constructed in situ between forms. Over the well is laid a heavy slab of reinforced concrete, upon which the masonry rests.

An extensive water supply system was built in 1902 for the Pasinger Paper Mill (see Fig. 259). The method of construction was as follows: First, a



FIG. 257.—Wells for the municipal electric plant of Bamberg.

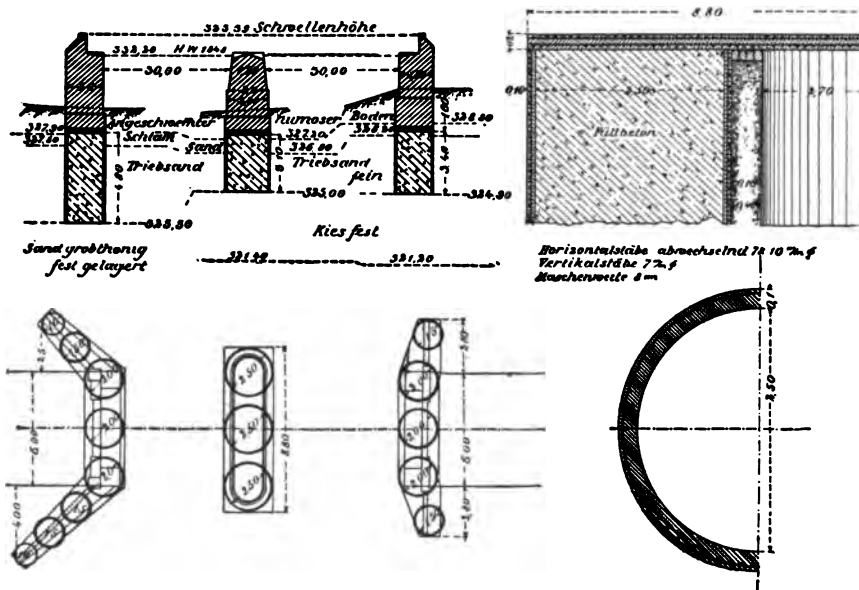

FIG. 258.—Well casing foundations for the Kocher Bridge at Bröckingen.

circular excavation was made in the gravelly soil, with fairly steep banks down to elevation o.o. Then the [] rings of the upper part of the well, fastened together

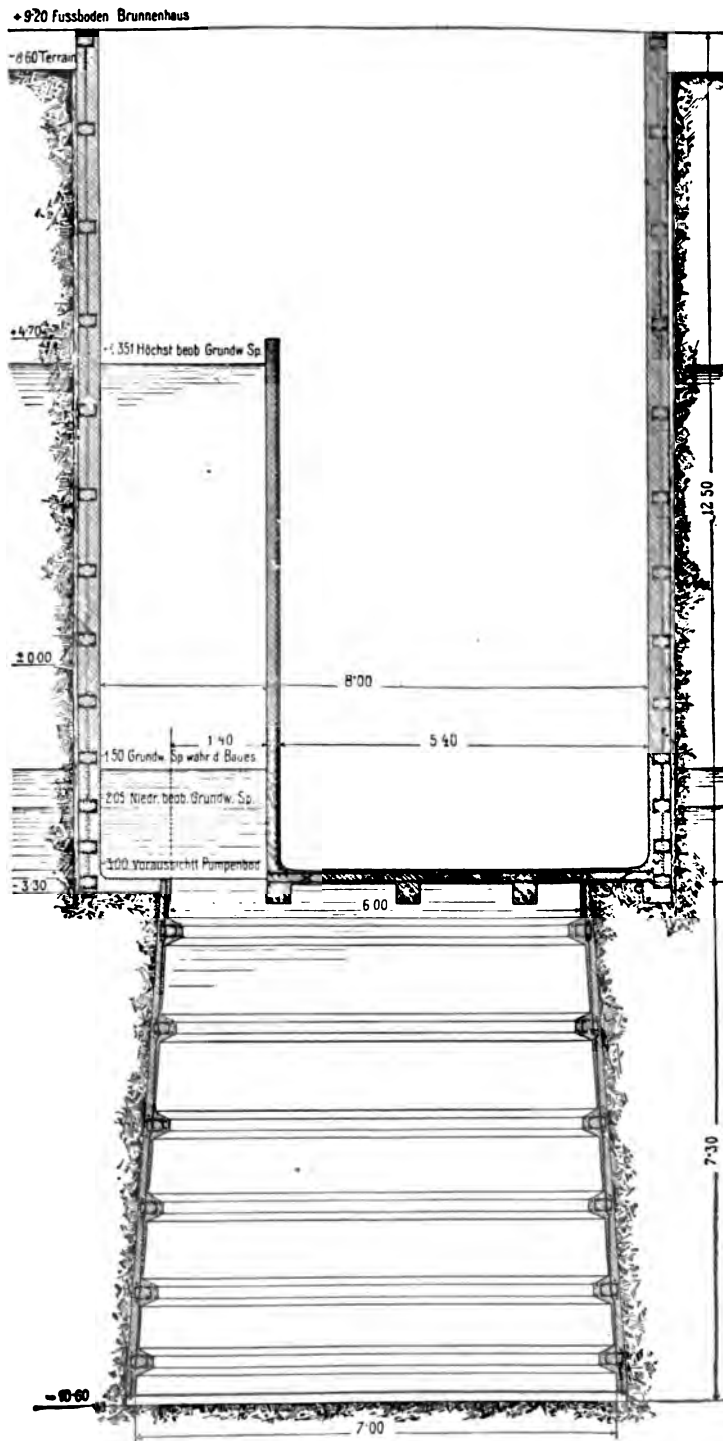

FIG. 259.—Reinforced concrete well for the Pasingen paper mill.

vertically by round rods, were erected, commencing at the bottom, and outside them wooden planks were placed and driven down as the excavation was deepened. At the same time the rings below the 0.0 level were placed, so that between grades 0.0 and -3.3 m., the shaft was excavated under partially water-tight conditions with vertical sides. At this point the construction of the casing proper was commenced at level 1.5,* this being above water level. Because of the heavy compressive stresses to which the casing would be subjected, it was constructed of reinforced concrete, with inwardly projecting ribs reinforced with especially heavy channels and round rods. The outside surface was finished smooth, and the lower edge was provided with a cutting ring. During the sinking operation, sub-aqueous excavation was not employed because of practical considerations, the water being kept down and the material removed by mechanical appliances. To drain the excavation, large centrifugal pumps and electric motors were set up on steel elevators erected on the heavy ribs of the casing, so that the machinery could be easily raised, should the electric current fail. Upon the completion of the sinking of the casing, the concreting of the lining and of the reinforcing rings above level -3.3 was undertaken, and at the same time a water-tight reinforced concrete floor was installed over about $\frac{3}{4}$ of the area of the well, and a reinforced concrete wall carried from this floor above the level of the highest ground water. In this way a convenient entrance was provided to the well proper, as well as a perfectly water-tight spacious pump chamber, at a depth which lessened the suction on the pumps. Iron steps made pump pit and well easily accessible. Above ground, the well was inclosed by a small building which accommodates the power machinery.

Concrete and reinforced concrete pneumatic caissons are discussed in a paper by K. E. Hilgard, in the Transactions of the American Society of Civil Engineers, Vol. 63, 1904. According to this paper, such caissons have been used in large numbers in Switzerland for foundations for bridge piers in the correction of the course of the Rhine, and as foundations of turbine pits.

WATER-TIGHT CELLARS

In all cases where the highest ground water level is above the bottom of a cellar which it is desired to maintain in a useful condition, a water-proofing of the walls and bottom is necessary. An excellent method of water-proofing the floor is to employ shallow inverted reinforced concrete arches, which span directly between the foundation walls in the form of cylindrical arches, or are built as groined arches between the walls and the intermediate column foundations of the building. On these arches a water-tight cement finish is laid which really acts as the water-excluding medium, and consequently must be protected from injury by a concrete filling over it. This filling concrete is leveled and finished with a wearing coat. At the walls, the arches are anchored and continued as a wall coating of concrete with proper reinforcement, on which concrete the

* Probably -1.5.—(TRANS.)

water-proofing is applied. Should the purpose for which the cellar is to be used so demand, the wall coat must also be protected from injury.

In Fig. 260 is shown the woven wire reinforcement in a portion of the new building for the Daimler Motor Company. The cellar construction was first planned, so that the column foundations were to be walled and coated. A



FIG. 260.—Woven wire reinforcement for a water-tight cellar in reconstruction of the Daimler motor factory in Unterturkheim.

certain amount of continuity of construction beneath the foundations was effected by pumping cement grout into the gravelly soil immediately under the columns. The arches are inverted groined ones. In Fig. 260, the reinforced coating of water-proof cement for the column foundation is shown completed, while the metal grid for the floor arches is clearly visible.

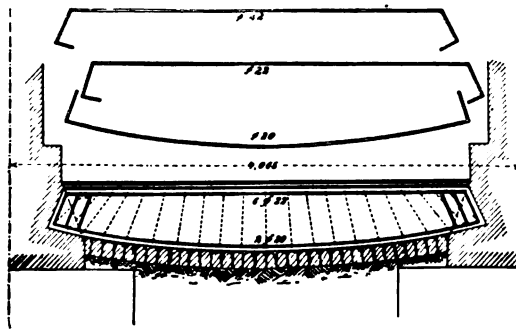

FIG. 261.—Reinforcement of the beams of a water-tight cellar.

Another form of construction with floor arches 8 m. (26 ft.) wide abutting against reinforced concrete beams, is shown in Fig. 262. The necessity of water-proofing was discovered only at a late stage of construction, and groined arches were impracticable, because of the long rectangular spaces between columns. Wedge-shaped reinforced concrete beams were therefore constructed between the column foundations, and between the beams, flat, 8 m. (26 ft.) span,

barrel arches were built. In Fig. 261 the details of the reinforcement are shown, especially the arrangement of the beam reinforcement to withstand shearing stresses. The ground water level was 1.3 m. (4.2 ft.) above the cellar bottom.

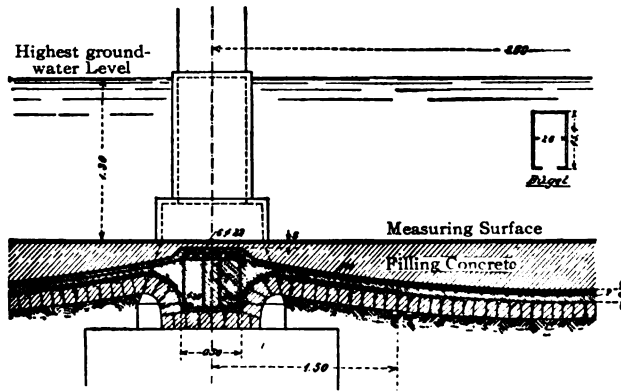

FIG. 262.—Section through beams and arches of a water-tight cellar.

Similar proofing against ground water is often required in the boiler pits of steam heating systems. In this case, however, the water-proof cement coating must be made to resist the radiant heat of the boilers.

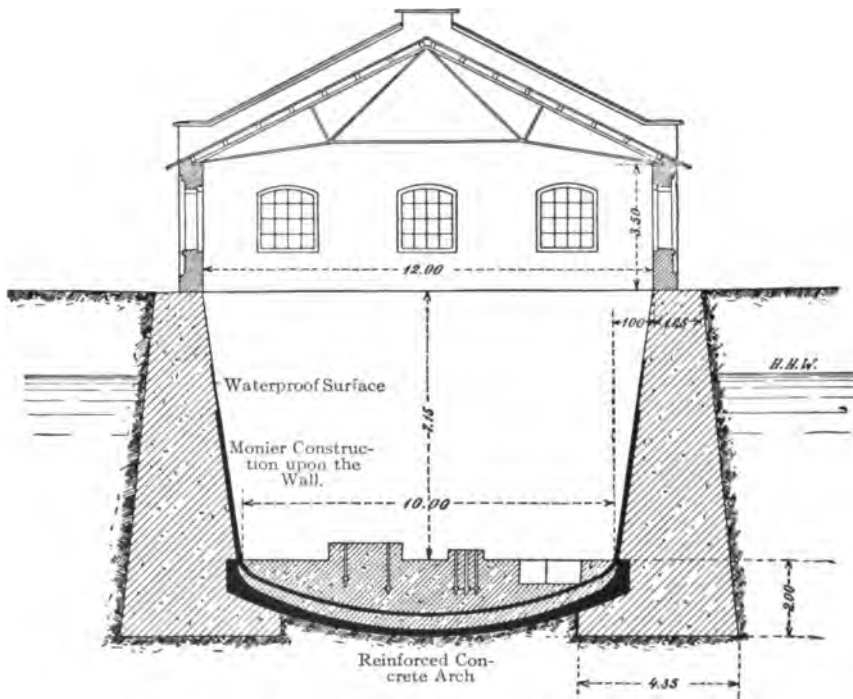

FIG. 263.—Pump house of the Wolsum pulp mill.

In the pump-house of the pulp mill at Walsum, the bottom of the pump chamber had to be water-proofed against a high water level, 7 m. (23 ft.) above

the floor. Because of this heavy pressure two reinforced floor arches, one over the other, were employed, each with a water-proof layer, and both joined to the reinforced wall covering. The arrangement is shown in section in Fig. 263.

PILES

Reinforced concrete bearing piles and sheet piles have the advantage when compared with those of wood, that the concrete ones may be used above ground water level, whereby a considerable saving on the whole foundation may be effected. The reinforcing of the common square pile corresponds exactly with that of a reinforced column, the longitudinal rods being combined at the pointed end in an iron shoe. A good connection between the longitudinal rods by ties spaced not too far apart is very important, just as for columns. Further, so as to distribute the impact during driving, it is necessary to interpose some medium between the pile driver hammer and the pile, and also use a solid cap inclosing the head of the pile, to prevent its destruction. This variety of pile was introduced in excavation work by Hennebique. A detailed description of the subject was given by Diemling in "Beton und Eisen," No. II, 1904.

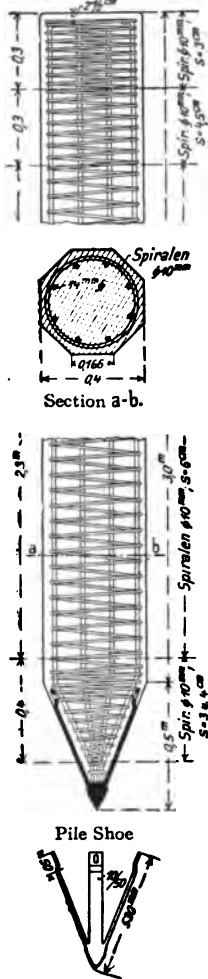

FIG. 264. — Reinforced concrete pile for the top of the canal in Mülhausen in Alsace.

On account of its high compressive strength, spirally reinforced concrete is especially suitable for piles. The section is then usually circular or octagonal. Because of the excellent results which have been attained in Paris on Considère piles, which have been driven without any protecting device,* Wayss and Freytag acquired the exclusive rights to spirally reinforced piles and have secured excellent results in numerous instances. Fig. 264 shows the construction of one of the reinforced piles for the top of the 600 m. (2000 ft. approx.) long and 37 m. (121 ft.) wide, Ill-Hoch canal in Mülhausen in Alsace. The driving took place when the concrete was only six weeks old. The load to be carried by each pile was 36 t. (39.6 tons); the reinforcement consisted of 8 longitudinal rods 14 mm. ($\frac{9}{16}$ in.) in diameter and a spiral of 10 mm. ($\frac{3}{8}$ in.) material with a pitch of 6 cm. (2.4 in.) which was reduced to 3 cm. (1.2 in.) at the head and the point. The wrought-iron point had four prongs, the upper ends of which were slightly offset and were punched. At the offset was a turn of the spiral and the holes provided a firm attachment between the pile shoe and the interior structure. The 1200

* See Deutsche Bauzeitung, 1906, Zementbeilage, No. 21.

kg. (2645 lb.) hammer fell with a 1.3 to 1.5 m. (4.2 to 5 ft.) drop upon an oak block.

In Figs. 265-267 are shown the fabrication of the reinforcement, the placing of the concrete in the horizontal forms, and a stock of complete piles with some finished units of reinforcement. The latter were built by placing upon a bench the spiral, which had been formed upon a reel, the longitudinal rods were then put in place and wired to every second or third turn of the spiral. The concrete was mixed in proportions of 1:4½. The forms were so arranged that the side



FIG. 265.—Factory in Metz. Fabrication of pile reinforcement.

boards could be removed in one or two days, while the pile remained upon the bottom piece for about 8 days.

For the foundations of the station in Cannstatt, piles from 5.5 to 10 m. (18 to 33 ft.) long were driven after hardening from 35 to 45 days. Their section and reinforcement were exactly like those of Fig. 264. The driving was done with a Mench and Hambrock steam pile driver. The 2750-kg. (6050 lb.) driving mechanism consisted of a ram with lifting rope. As a guide for the wooden block, a wrought-iron cap was used, which also prevented a splitting of the concrete, because it completely inclosed the pile head. Between the pile and the block was a layer of sawdust to lessen the impact. Concrete piles provided with spiral reinforcement possess such impact resistance that the wooden block may be entirely omitted and the hammer allowed to strike directly on the concrete. It may crumble the concrete of the head somewhat, as is shown in Fig. 270, for which no cushion was used. This damaging of the pile top is without danger,



FIG. 266.—Factory in Metz. Placing concrete in pile forms.



FIG. 267.—Behrend Building, Kiel. Stock of finished piles and some reinforcement units.



FIG. 268.—Station in Cannstatt. Hoisting piles.



FIG. 269.—Business building in Metz. Driving piles.

since this concrete must almost always be removed to build the reinforced concrete beam or column, so that the reinforcement for the new member can be joined to that of the pile, and then all concreted together. In a similar way, reinforced concrete piles can be spliced. In the foundations of the station in Cannstatt, the piles were driven with a hammer fall of about 1 m. (3.3 ft. approx.), the penetration being 4-5 mm. ($\frac{5}{32}$ to $\frac{3}{16}$ in.). The maximum performance of the driver was 100 running m. per day (328 ft.).

In computing the carrying capacity of the piles, the Brix formula is usually employed.



FIG. 270.—Station in Cannstatt.
Head of pile which was driven without cap or driving block.

$$p = \frac{hQ^2g}{2e(Q+g)^2},$$

wherein h is the fall of the hammer;

Q the weight of the hammer;

g the weight of the pile;

e the penetration of the pile under the last blow;

p is double the safe allowable load for the pile.

The quantity e will naturally be the average of the last few blows.

Fig. 269 shows a steam pile driver at work on a new business building in Metz.

CHAPTER XIII

APPLICATIONS OF REINFORCED CONCRETE

BRIDGES

(a) **With Horizontal Members. Slab Culverts.**—In the early stages of railroad construction, culverts roofed with natural stone were extensively employed. With the advent of concrete and of cement pipe, arched conduits easily constructed in concrete or, for smaller openings, cement pipes were substituted. With the introduction of reinforced concrete, however, slab culverts again became



FIG. 271.—Laufbach Bridge in Laupheim. Placing Reinforcement.

useful. Since it is possible with the aid of reinforcement to make the concrete slab resist any bending stress, the span of the slab or the clear way of these culverts can be increased to about 6.5 (21 ft.), so that their field of usefulness has been greatly extended. The span might be still further increased, but beyond about 5m. (16 ft.), T-beams are cheaper than simple slabs.

Slab culverts with reinforced concrete covers, are used over railroads as well as for streets. For instance, Wayss & Freytag constructed for the Gaildorf-Untergröningen Railroad a whole series of such culverts, and in the station at

Söflingen, a foot tunnel of this same sort. Figs. 271-273 show the construction of a slab culvert of 4 m. (13 ft.) clear span under the market place of Laupheim. The 35 cm. (13.7 in.) slab was calculated for a steam roller. It was built with 12 rods, 16 mm. ($\frac{5}{8}$ in.) in diameter per m. width (39.37 in.), 9 being straight and 3 bent upwards at the ends. Its surface is crowned to discharge surface water. The test loading showed no measurable deflection. Numerous similar slabs under streets, up to spans of 6.5 m. (22 ft.), have been built.

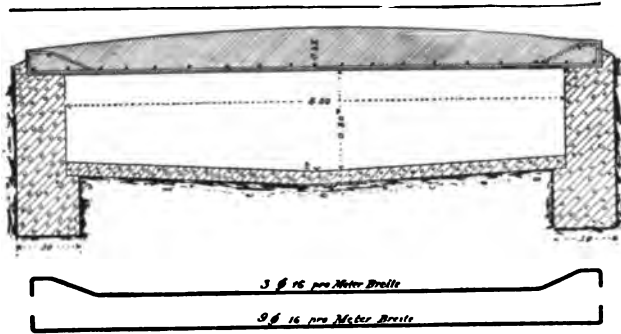

FIG. 272.—Laufbach Bridge in Laupheim. Cross-section.

The abutments of such culverts are usually built of concrete, but use is often made of existing ones of masonry. The slab covers the abutment, thereby effecting a saving in wide spans through a saving of masonry. The slabs are usually constructed at the site, on forms, but have also been made in sections 80 to 100 cm. (30 to 40 in. approx.) wide, and placed after hardening. This is necessary where no interruption to traffic can be allowed, one-half the street being first constructed, the traffic then diverted over that portion while the other half is completed.

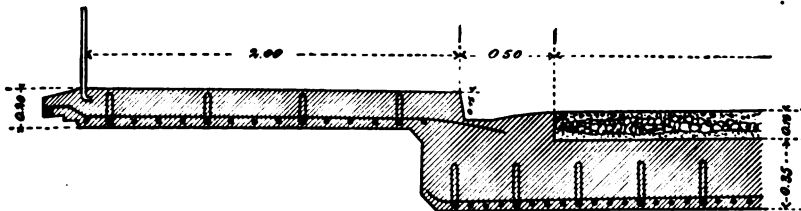

FIG. 273.—Laufbach Bridge in Laupheim. Longitudinal section showing thoroughfare.

Under railroad embankments, the strength of the reinforced concrete slab can always be suited to the load, by reducing the thickness towards the ends of the culverts. Walls over the ends of the culvert to retain the fill and shorten the length of the masonry work can advantageously be employed and anchored to the slab by the cross rods.

Cantilevers.—Reinforced concrete slabs can be employed not only as members between two supports but also when secured at one end, the other projecting freely. This form of construction can be employed for instance for widening a street along a river. The sidewalk can then be allowed to project over the

river, as in Fig. 274. Naturally the reinforcement must then be placed near the upper surface, and be anchored in a block of concrete behind the wall of the embankment, the block being of sufficient size to prevent the overturning of the walk. Such an arrangement was built by Wayss & Freytag at Wildbad. In a similar manner the footwalks of old bridges may be arranged in order to widen the roadway.

Reinforced concrete slabs can also be used to advantage as the flooring of steel footbridges and viaducts, and also for the construction of the flooring of the main thoroughfares of bridges in place of Zores* iron and buckleplates. The cost of such structures will be lessened by the employment of reinforced concrete and in all cases the construction will be simplified. The slabs for sidewalks are, in most cases, made in advance, and then laid. They may be

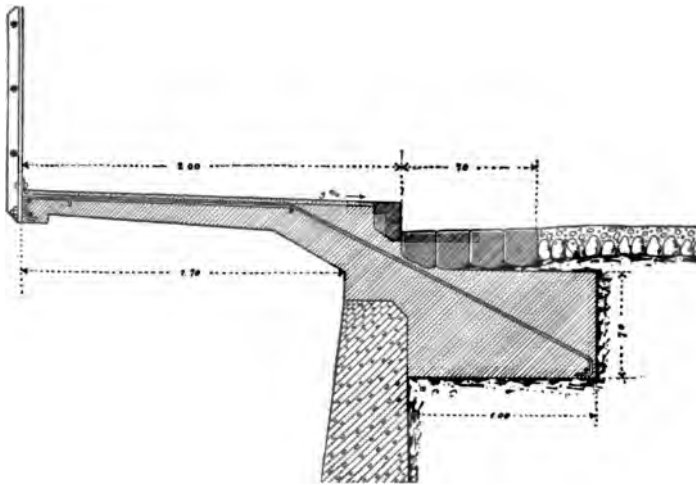

FIG. 274.—Cantilevered sidewalk, Schramberg.

made with a cement surface coat, or an asphalt wearing surface can be applied after laying. The reinforced concrete construction of main bridge thoroughfares consists of continuous reinforced slabs that are supported either between the longitudinal beams or usually between the cross beams, and are reinforced according to the maximum moment diagrams.

T-Beam Bridges.—For larger spans, the rectangular slab section is uneconomical, and T-beams are usually employed for the carrying members of spans exceeding about 5 m. (16 ft.). The usual arrangement is to span the opening with several similar parallel girders and lay a floor slab between them. With reference to the concentrated load of a steam roller, a girder spacing of between 1.3 and 1.6 m. (4.2 to 5.2 ft.) should be used, and for the same reason, and because of the unequal deflection of the girders, the floor slabs should have straight rods the full width both above and below, as well as bent ones, and numerous distributing rods.

Such a T-beam bridge with a clear span of 12.07 m. (39.6 ft.) (the Hornbach Bridge at Zweibrücken) is shown in Figs. 275–276. The bridge is skew,

* Z-bars, Phoenix column shapes, and some other similar sections.—(TRANS.)

and rests partly on pre-existing stone masonry abutments. The girders are connected by cross-beams, which serve to distribute more uniformly over several girders the concentrated loads and those of the brackets on which the reinforced



FIG. 275.—Hornback Bridge near Zweibrücken.

concrete slabs of the sidewalk are supported. As reinforcement, the girders have five straight round rods of 30 mm. ($1\frac{3}{8}$ in.), and five bent ones of 28 mm. ($1\frac{1}{8}$ in. approx.) diameter, the bending of the latter being arranged to care for

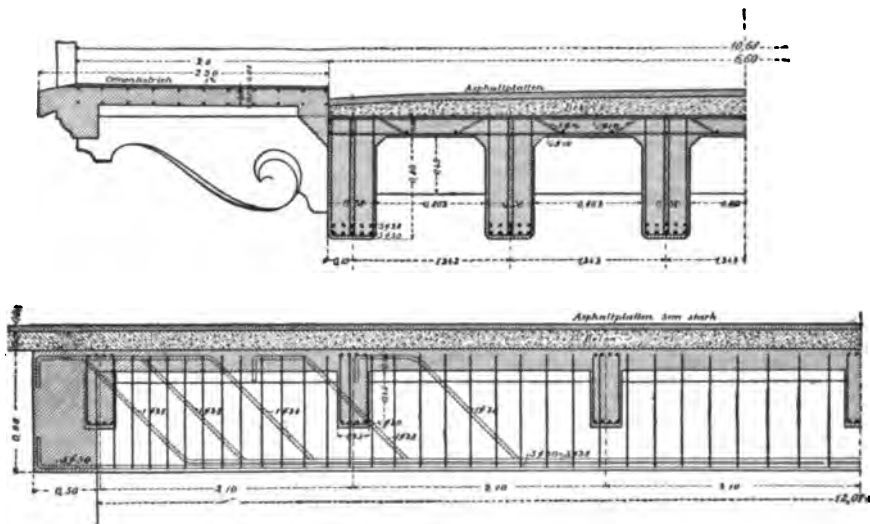

FIG. 276.—Hornback Bridge near Zweibrücken. Cross and longitudinal sections.

the diagonal tensile stresses produced by the shearing forces. Under the test load of a 20 t. (22 ton) steam roller, the girders were deflected only 0.3–0.4 mm. (0.015 in.

T-beam bridges of this type, of spans up to 16 m. (52 ft.) are entirely practicable, and in most cases cheaper than steel bridges. Special instances occur of 20 m. (66 ft.) spans, and unconnected girders also exist, such as are shown in Fig. 277. With longer spans, the girders become rather heavy, so that T-beam bridges possess little superiority over steel ones.

In narrow bridges, up to 6 m. (20 ft.) width, less depth is involved when only two parallel girders are employed, and the weight of the roadway is transferred to them by cross beams. Such small depth is important where railroads have to replace grade crossings by bridges. An example of such a case is shown in Figs. 278–281, of a bridge at Grimmelfingen, near Ulm. The girders with a clear span of 9 m. (30 ft.) have a rectangular section 70 cm. (27.6 in.) wide, and



FIG. 277.—Bridge near Krapina, with open girders of 200 m. (66 ft.) span.

extend up above the roadway, thus forming a low parapet, upon which only a small railing is necessary. The reinforced concrete slabs which carry the roadway and span the 1.533 m. (5 ft.) spaces between beams, are covered with a watertight coating of layers of asphalt felt. Ready drainage is effected not only by a slope toward the girders from the center of the roadway, but also by a slope toward the abutments from the center of span. The roadway proper is constructed of concrete.

The static computation was made for a load consisting of a crowd of people of 450 kg/cm² (92 lbs/ft²) and a 6 t. (6.6 ton) wagon with a 1.5 t. (1.65 ton) wheel load. The first loading determined the girders, while the latter affected the deck slabs and the floor beams. The calculation and dimensioning of the deck was based on the assumptions of continuity throughout the several panels, and of free support of the beams. The reinforcement consisted of seven round rods of 7 mm. ($\frac{1}{8}$ in. approx.) diameter per meter width, above and below, throughout,

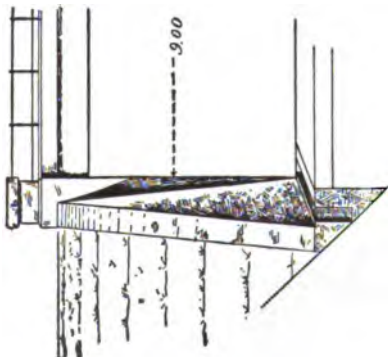

FIG. 278.—Side view.

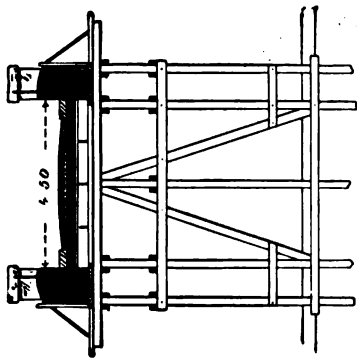

FIG. 279.—Cross-section with falsework.

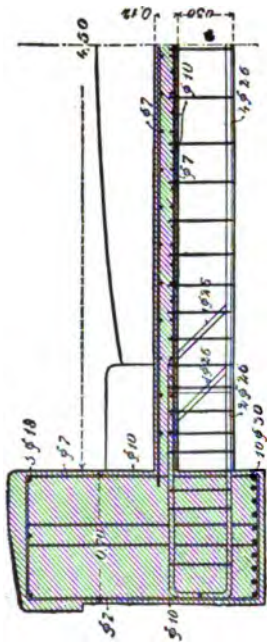

FIG. 280.—Cross-section, detail.

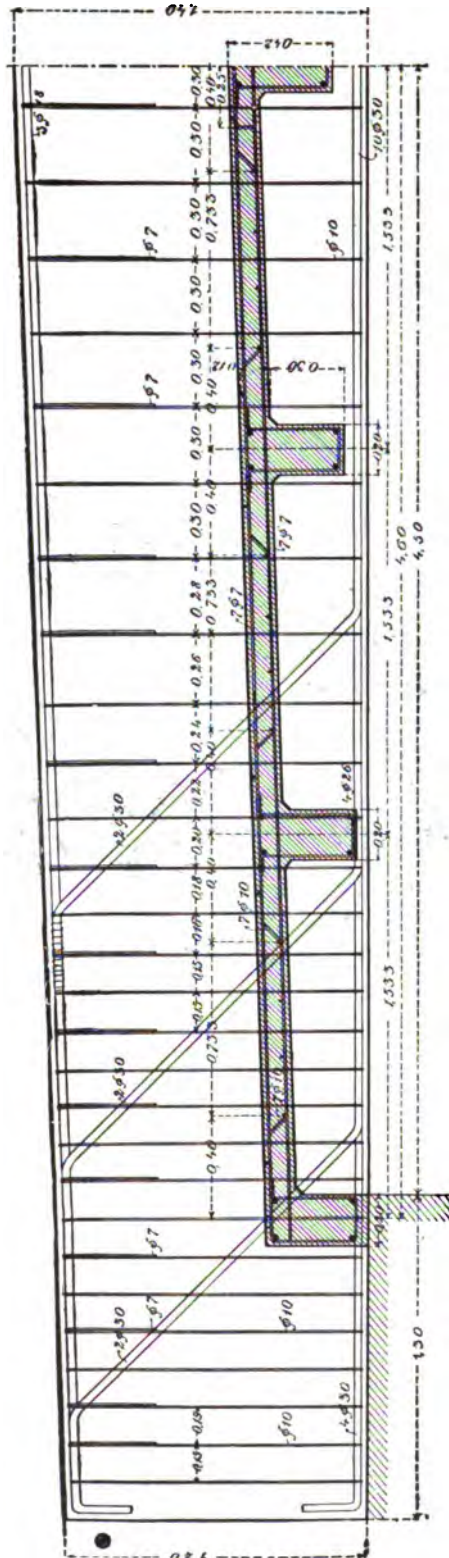

FIG. 281.—Highway Bridge at Grimmelfingen. Longitudinal section. Detail of the deck and the main girders.

and of seven bent rods, 10 mm. ($\frac{3}{8}$ in. approx.) diameter, bent upward in the vicinity of the beams and carried over them.

The cross beams were calculated without regard to possible end restraint. At the same time, however, the arrangement of the reinforcement provides some rigidity at their connections with the girders. Of the four rods (26 mm.— $1\frac{1}{8}$ in. approx.) required at the centers of the beams, two are bent upward near the girders, at points where their area is not required in the lower chord.

The two girders are not anchored at the abutments and consequently must be considered as freely supported beams of rectangular section. Of the ten



FIG. 282.—Highway Bridge in Grimmelfingen near Ulm. Tested to 450 kg/m^2 (92 lbs/ft^2) with gravel; deflection 0.2 mm. (0.008 in.).

round rods, each of 30 mm. ($1\frac{1}{8}$ in. approx.) diameter required at the center, at special points six are bent upward at an angle of 45° to resist in the most effective manner the shearing or diagonal tensile stresses. Naturally, the bending is done at points where the moment is sufficiently reduced. The bent ends are carried over the supports so that possible reverse moments may be resisted.

The zone of compression of the girders is reinforced with three round rods 18 mm. ($\frac{11}{8}$ in.) in diameter, connected together and anchored in the concrete of the girders by 7 mm. ($\frac{1}{4}$ in. approx.) stirrups. They strengthen the upper side of the girder against compressive stresses.

An important advantage of such reinforced concrete bridges over railways, is that they are not affected by the gases from the locomotives, which, in the case of busy stretches of track, and where difficult of access, cause active corrosion and high maintenance charges for steel structures. Fig. 283 gives an instruc-

tive illustration of the destruction wrought by smoke gases in unfavorable conditions. The piece there shown was removed early in 1907 from a steel longitudinal girder under the roadway of a bridge over a freight station erected in 1886.

If the length of a horizontal reinforced concrete bridge is greater than 16 to



FIG. 283.—Rusting of a main girder by locomotive gases.

20 m. (43 to 66 ft.), intermediate supports must be provided. They may consist of ordinary masonry intermediate piers, especially where such may have been left standing from a previous wooden bridge; but usually, however, are made of reinforced concrete in the shape of columns. It is best to place a separate support under each girder, and to connect the columns at the base by means of a common pedestal and a single foundation.

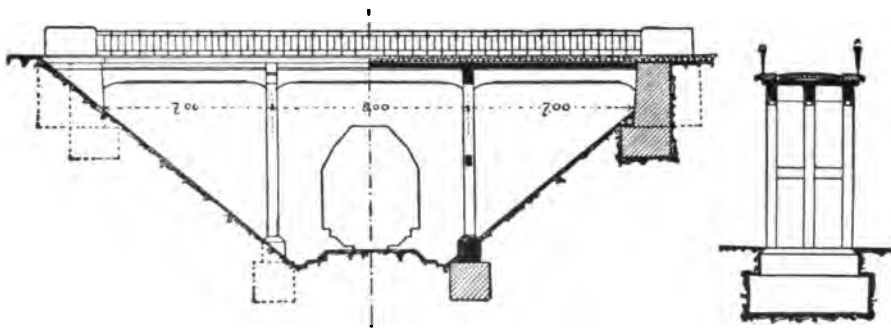

FIG. 284.—Reinforced concrete bridge over a railroad cut.

Continuous members with three spans are well adapted for bridging railroad cuts (Fig. 284), a considerable saving being effected in abutment masonry.

In Fig. 285 are shown the entire design and details of a section through the thoroughfare of such a bridge over a ravine at Bad Tölz. In this case the abutments are carried down through the shifting soil to bedrock on tubular piles of

reinforced concrete. The reinforcement of the continuous bridge girders is designed exactly like those of buildings. Fig. 286 shows a view of this bridge.

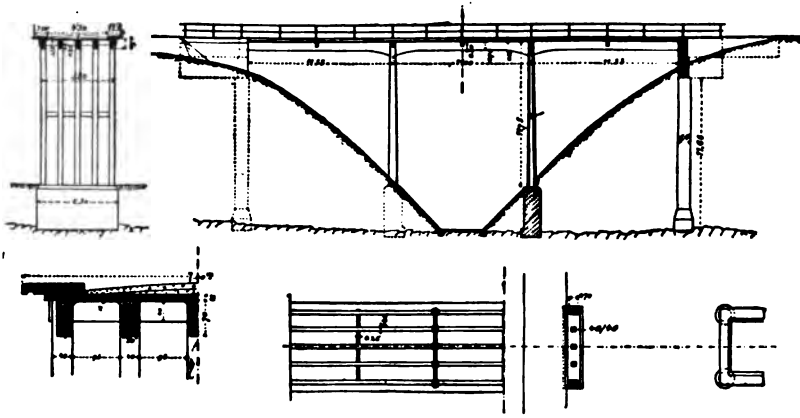

FIG. 285.—Bridge over a ravine near Bad Tölz.

In straight girder bridges of greater length an expansion joint must be provided about every fourth opening. This necessitates cutting one of the



FIG. 286.—Bridge over a ravine near Bad Tölz.

piers longitudinally, or constructing two piers close together and allowing the girders to project over them as cantilevers. Bracketed beam ends may often be employed to advantage in reinforced concrete bridge construction. Pains should

be taken to arrange the supports of reinforced concrete bridges so that the pressures at those points are properly carried. In small bridges, sliding and tangential tilting supports are suitable, roller bearings being useful only in exceptional cases. Practice has indeed not yet shown the absolute necessity of such devices for reinforced concrete construction, since at such points much smaller movements take place, and where girders are supported by columns such devices are of small moment, because of the elasticity of the column. Where necessary, the secondary stresses so produced can be calculated. With beams of only a single span, dangerous though invisible conditions exist with rigid supports, since the bottom of the beam lengthens from the tensile stresses which appear



FIG. 287.—Cover of the Ill-Hochwasser Canal, Mülhausen.

when the forms are removed, and the beam exerts a pressure on the abutments, which is bad for both beams and wall. In continuous beams, however, which rest on masonry center piers, such an arrangement, when properly constructed, is advisable.

All varieties of deck structures are identical in principle with T-beam bridges, especially those over streams and railroads. In those over streams it often happens favorably that existing river walls may be used as abutments for shear-free constructions. In covering railroad cuts, the principal advantage of reinforced concrete is its capacity to withstand the locomotive gases.

An extensive cover of this kind in Mülhausen, in Alsace, over the Ill-Hochwasser canal is shown in Fig. 287. The work illustrated includes a deck 36 m. (118 ft.) wide and 660 m. (2165 ft.) long. The beams, spaced 3 m. (9.8 ft.) apart, were continuous over spans of 11, 14 and 11 m. (36, 46 and 36 ft.) with ends

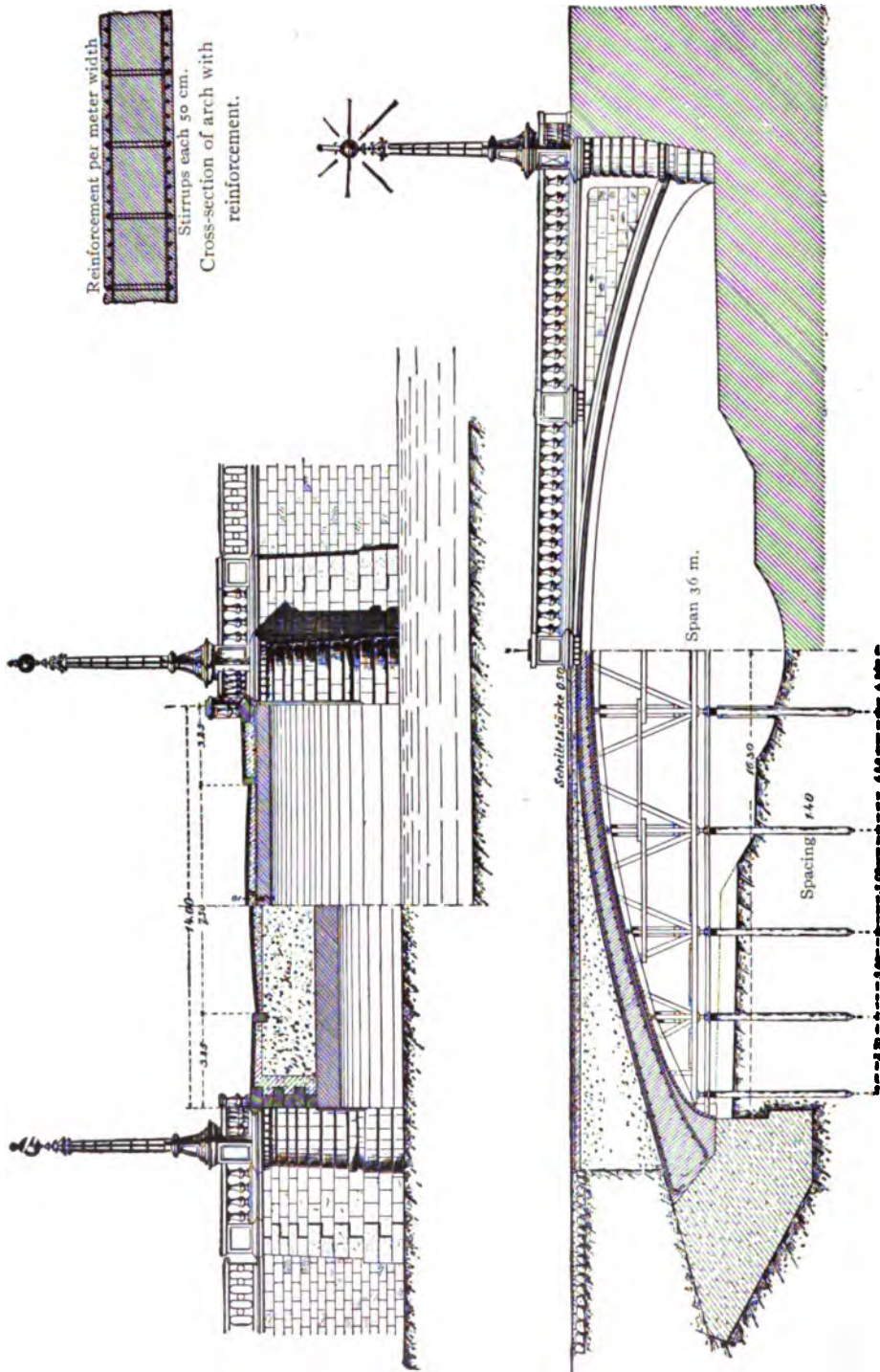

FIG. 288.—Galfinger Bridge in Mulhausen. Longitudinal section and elevations.

elastically restrained by reinforced concrete columns in the side walls. They were designed with that end in view and were computed for a live load of 500 kg/m² (102 lbs/ft²). Since these reinforced concrete columns, which had also to resist the earth pressure, were inclosed in the wall construction, it was possible to construct the girders with less depth. The 7 m. (23 ft.) high, octagonal, intermediate supporting columns rested on the reinforced concrete piles described previously (Fig. 264). Between the columns, 5 m. (16 ft.) high reinforced concrete walls were erected, so that at high water it flowed in three separate streams. These partitions afforded a stronger protection for the columns and a considerable stiffening of the construction in a longitudinal direction.

Four streets crossed the canal, and it was because of the high loads from street cars and heavy trucks that this specially strong construction was required.

The largest piece of work of this description is that of the Vienna Municipal Railroad, which extends 2 km. (1.24 miles) with spans of 12.7 m. (41.6 ft.), and was constructed by G. A. Wayss & Co., of Vienna.

(b) **Arch Construction.**—In arched bridges, reinforced concrete can be employed either for the arch alone, or the superstructure including the roadway, or in all structural parts. In small spans, the reinforcement in the arch enables the full compressive strength of the concrete to be utilized, since the tensile stresses are independently resisted. In medium spans of 40 to 50 m. (130 to 165 ft.), the employment of reinforced concrete as the arch material is less frequent, since in this case, provided a proper profile has been employed, no tensile stresses occur, because of the large dead load. On the other hand, reinforced concrete is better adapted for long spans. If the safe compressive stress in the arch is not to be exceeded, it is necessary to limit the weight of the superstructure, and this can be done by a suitable employment of reinforced concrete. In this way the dead load stresses will be greatly reduced, but the small edge stress may decrease to zero, or change to tension under unfavorable live loads, so that reinforcement is again necessary.

In consequence, where it is desired in small and medium spans that no tensile stresses shall exist, or in other words where only concrete work is employed, the superstructure cannot be kept too light. A light superstructure is then justifiable only when demanded for architectural reasons or when it is necessary to impose as little weight as possible on the foundations.

An example of a reinforced concrete bridge without special superstructure is shown in Fig. 288. The arch of 36 m. (118 ft.) span and 4.2 m. (13.8 ft.) rise, is 50 cm. (20 in.) thick at the crown and was computed as fixed at the ends.* The reinforcement consisted of ten 14 mm. ($\frac{9}{16}$ in.) rods near both the top and the soffit of the arch, and at distances of about 50 cm. (20 in.), the two systems of rods were tied together by 7 mm. ($\frac{5}{16}$ in. approx.) stirrups. At the springings the arch rested with a widened foot upon the abutment concrete so as to secure the assumed, computed restraint. The arch is faced with ashlar masonry. The space between the asphalt waterproofed top of the arch and the roadway is filled with gravel, upon which rests the concrete foundation of the asphalt street surface. The arrangement of the arch centers and other details is also

* See article by the author published in the "Schweizerischer Bauzeitung," 1908, Nos. 7 and 8; and also the separate brochure, "Berechnung von eingespannter Gewölben."

shown in the illustration. The maximum stresses amounted to 37.4 kg/cm^2 (532 lbs/in^2) compression, and 0.1 kg/cm^2 (1.4 lbs/in^2) tension, the reinforcement being thus only a safeguard in case an abutment should settle and cause an increase in the tensile stresses.

During the last twenty years a large number of bridges similar to this have been erected by Wayss & Freytag.

With regard to the application of reinforced concrete to the construction of the roadway and the superstructure over the arch, several arrangements are possible.

1. The reinforced concrete slab which carries the roadway may rest on 40 to 60 cm. (16 to 24 in.) walls of concrete or masonry, which are combined with the arch and carry the loads to it. The arches can be constructed either restrained or three hinged by using suitable material, entirely independent of the rein-

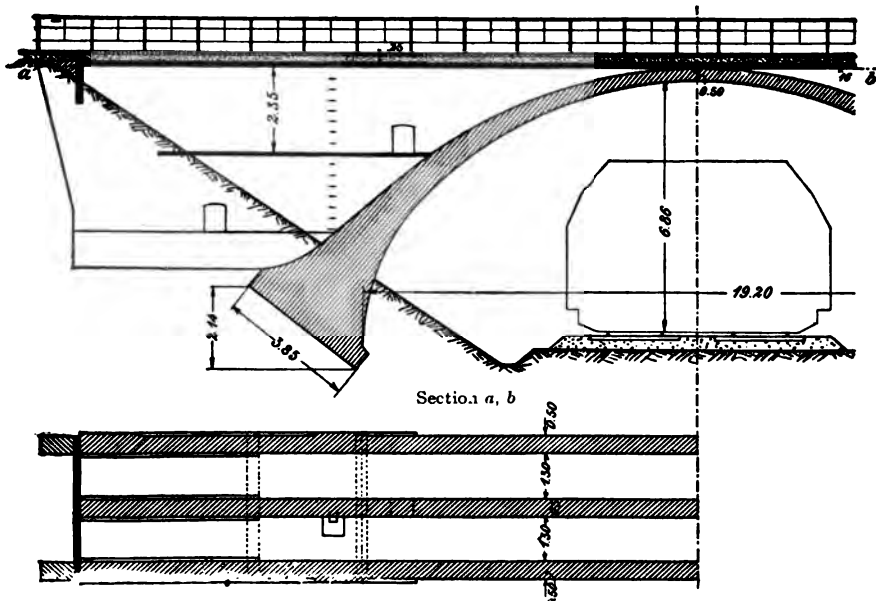

FIG. 289.—Highway bridge near Hamburg. Longitudinal and horizontal sections.

forced concrete construction of the roadway. The reinforced slabs of the latter correspond with the spandrel arches of the usual arrangement, but are more advantageous, because they may extend somewhat over the outside walls and because no horizontal shear is produced by spandrel walls. Consequently, a narrower arch is possible, with a saving in the abutments and piers. When spandrel walls of considerable height are used, it is wise to stiffen them with intermediate decks. A bridge of this arrangement of superstructure is illustrated in Fig. 289. The arch of that bridge consists of mass concrete without reinforcement. Since the ground behind the abutments slopes up to the level of the roadway, the longitudinal walls with the reinforced concrete slab resting on them could be extended into the ground over the abutments, so that wing walls and embankments were unnecessary. In this manner a saving in cost could be accomplished.

2. Over the arch, and at right angles to its face, cross walls can be erected to support the reinforced concrete construction of the roadway. These cross walls are usually placed at such a distance apart that a continuous reinforced concrete slab can be provided for the support of the roadway. The outside walls thus fall entirely beyond the arch, and the latter does not receive as much stiffening from the superstructure as in the last case, so that its form must be accurately designed and executed. Its superiority from a static point of view rests in the decreased load on the abutments and foundations.

The arrangement with cross walls is very light and pleasing in appearance. The walls may be constructed of masonry, or of concrete, with or without reinforcement. The latter kind of construction permits a narrow width to be employed and may be used when the arch consists of reinforced concrete.

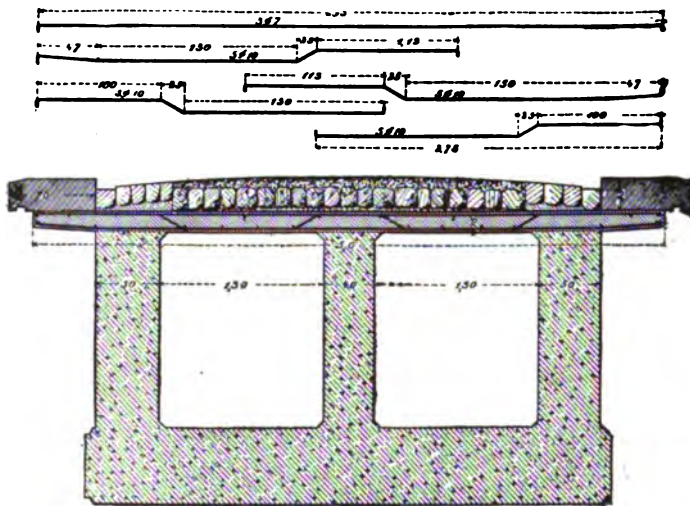

FIG. 290.—Highway bridge near Hamburg. Section through superstructure and thoroughfare.

In Fig. 291 is illustrated a foot bridge over the canal near the Grosshesseloher railroad bridge. The pleasing appearance is secured without employing architectural adornment, but solely through the structural work, all conspicuous parts of which consist of reinforced concrete.

A highway bridge of the same type is shown in Fig. 292. The bridge has a 32 m. (105 ft.) span, and was erected on the site of a dilapidated wooden one.

In Figs. 293–294 are illustrated a foot bridge on the Metz-Vigy line. The axes of the ribs in these bridges were assumed as parabolas, so as to be able to apply advantageously available formulas for the immediate computation of the influence line for the load point moments of a restrained parabolic arch. Since usually the axes of restrained arches are assumed so as to coincide with the line of pressure for dead load, in the foregoing cases the assumption of a parabola was permissible, because the dead load is small and very nearly uniformly distributed over the span. It is to be especially noted that here the connection of the structure with the bank is effected by means of concrete walls which inclose a hollow space decked over with a reinforced concrete slab. In this way the earth pressure is diminished against the wing walls.

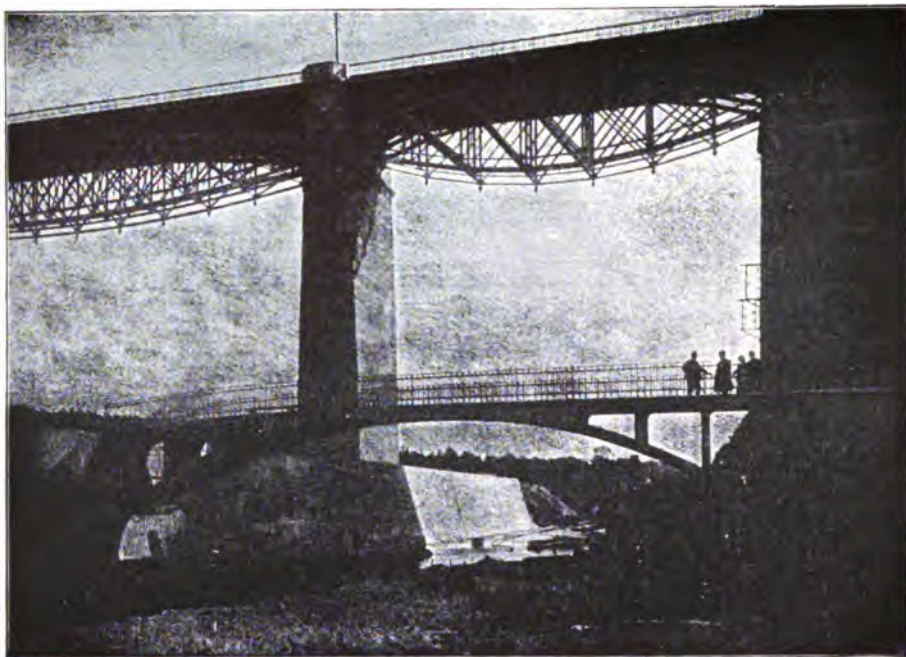

FIG. 291.—Foot bridge over the traffic canal of the water works for the city of Munich.



FIG. 292.—Highway bridge in Gunzesried (Allgäu). Span 32 m. (105 ft.).

3. The cross walls in the foregoing arrangement may be replaced with transverse rows of columns which carry the T-beam construction of the roadway. In this way the weight of the superstructure over the arch will be reduced as



FIG. 293.—Foot bridge over the Metz-Vigy Line. Test load.

much as possible, this arrangement being adapted for large spans. The best example to date of this class, is the Isar bridge in Grünwald (Figs. 295-304), a short description of which will here be given.*

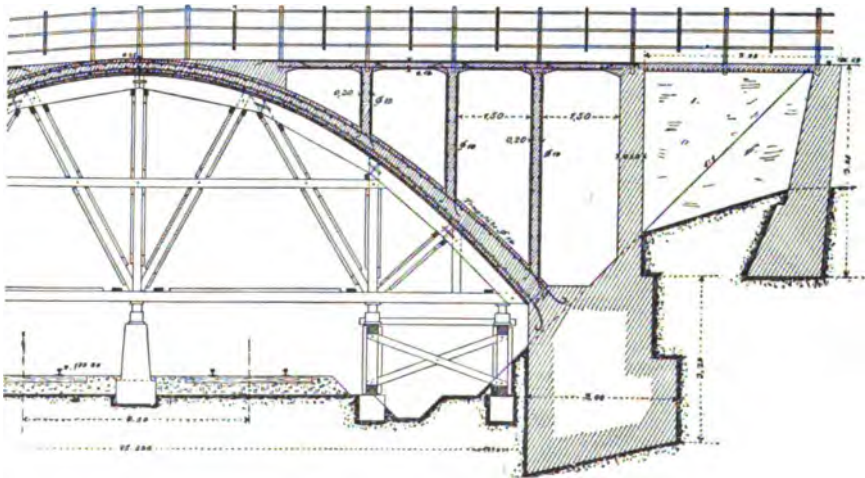

FIG. 294.—Foot bridge over the Metz-Vigy Line. Longitudinal section.

This bridge, which spans the Isar between Höllriegelsgreuth and Grünwald, was built by the reinforced concrete companies* of Munich after the designs of

* See article by the author in the "Schweizerische Bauzeitung," 1904, XLIV, Nos. 23 and 24, also published separately. Figures 296 to 304 are borrowed from that publication.

† Wayss & Freytag of Neustadt-on-the-Hardt, and Heilmann & Littmann of Munich.

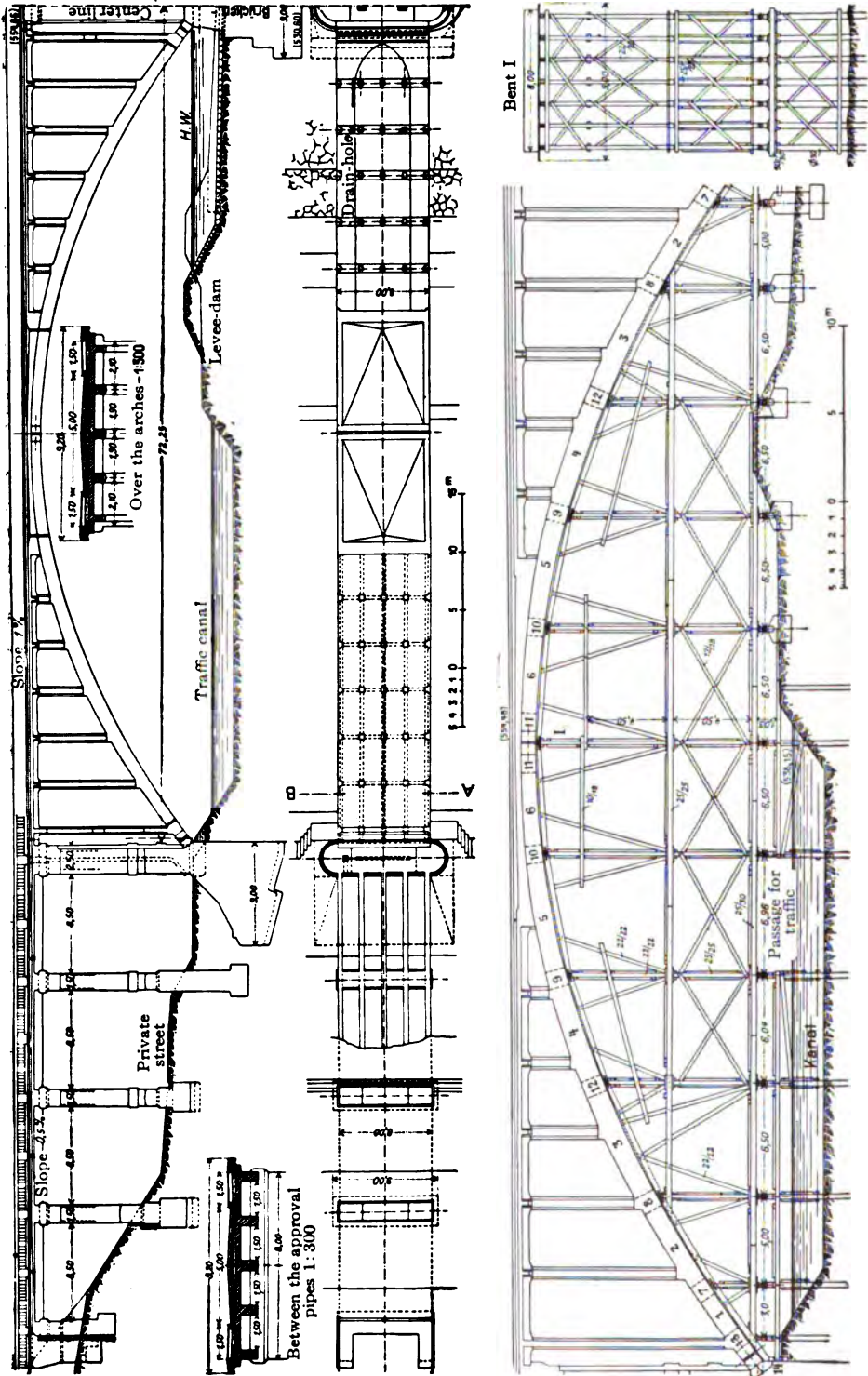

FIG. 296.—Isar Bridge near Grünwald. Longitudinal section, ground plan and centering for the left span.

the author. This highway bridge is of about 220 m. (722 ft.) length, with two arches of 70 m (229.6 ft.) span, each with a rise of 12.8 m. (42.0 ft.) over the beds of the river Isar and the power canal for the electric plant. These two main spans are finished on the right by a single, and on the left by four approach spans 8.5 m. (27.9 ft.) long, which are decked with a straight reinforced concrete structure.

The two main spans were designed as three-hinged arches. In determining the selection of this form of construction, besides its general excellence, one main condition also existed, that up to the date of the arrangement of this project, no positive data existed concerning the underlying conditions, so that much caution was necessary.



FIG. 295.—Highway bridge over the Isar near Grünwald.

The bridge was designed for a crowd of people of 400 kg/m^2 (82 lbs/ft^2), and a steam roller load of 20 t. (22 tons). As described by the author in the "Zeitschrift für Architektur und Ingenieurwesen," No. II, 1900, the arches were so proportioned as to form and thickness that at each section the maximum stresses in the upper and lower edges were equal to the one then considered permissible of 35 kg/cm^2 (497 lbs/in^2).

At the crown, the arch thickness was 75 cm. (29.5 in.), at the springing 90 cm. (35.4 in.), and at joints V and VI* it reached 1.20 m. (47.2 in.), its greatest thickness. No tensile stresses appeared, but the compression was reduced to 2.1 kg/cm^2 (29.8 lbs/in^2), with unfavorable loading.

For each centimeter (0.4 in.) which the arch rib deflected, the edge stress varied about 1 kg/cm^2 (14.2 lbs/in^2), so that with a deflection of 4 to 5 cm.

* Under the verticals counted from the abutments.—(TRANS.)

(1.5 to 2 in. approx.), tensile stresses would exist in sections IV–VI. Since such a deflection did not appear impossible through uncertainty of construction, or unequal lowering of the centers, the arch was provided with a reinforcement, which obviously was impossible of computation, and was introduced only as an additional measure of security. This reinforcement consisted of nine round rods 28 mm. ($1\frac{1}{8}$ in. approx.) in diameter, both above and below over the whole width of 8 m. (26.2 ft.). At distances of 1 m. (40 in.) the upper and lower steel was tied together by 7 mm. ($\frac{5}{16}$ in. approx.) round iron stirrups.

The hinges of cast steel were of the dimensions shown in Figs. 297–298, and their smoothed faces rested against squared reinforced artificial stones with a 4 mm. ($\frac{5}{32}$ in.) layer of sheet lead between. The pressure over the bearing area was 100 kg/cm² (1422 lbs/in²). The hinges were designed for a permissible

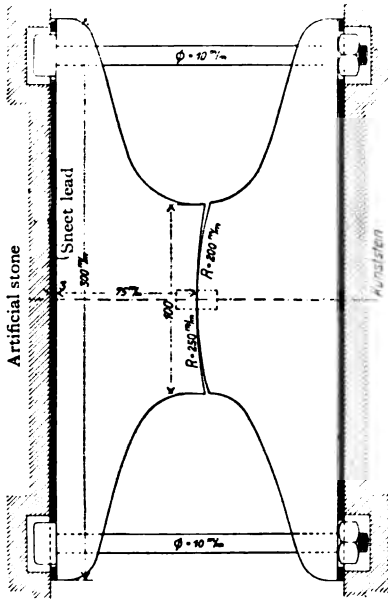

FIG. 297.—The abutment hinge.

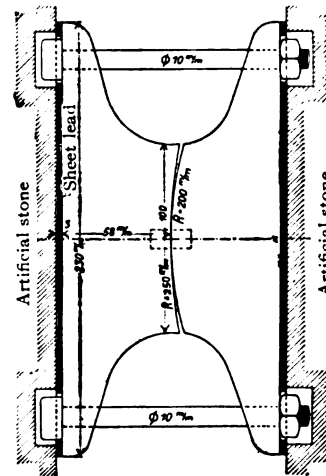

FIG. 298.—The crown hinge.

bending stress of 1100 kg/cm² (15,642 lbs/in²), and the two halves met on cylindrical surfaces of 250 and 200 mm. (9.84 and 7.87 in.) radii. Granite was first proposed for the hinge bearing blocks, but later, reinforced concrete blocks were selected because more economical, and after compression experiments made in Munich had disclosed good results. The hinge-bearing blocks are under pressure over only a part of their area. Similarly loaded test specimens failed by cracking in the direction of stress, so that a reinforcement was necessary, running at right angles to the direction of stress and transverse to the pressure areas, in order to increase sufficiently the ultimate strength.

In constructing the blocks, which were molded in perfect cast-iron forms with smooth surfaces, the reinforcement was uniformly distributed throughout the full height, since the cracks had appeared in the test specimen in the part between the pieces of reinforcement. The length of each block was 79 cm. (31 in.) and

corresponded with the length of a hinge piece, so that a single piece rested on each block. At the abutment hinges the parts were so arranged that both pieces of stone rested on the centers, thus making impossible anything except a simultaneous shifting.

The arch was concreted in separate sections, the size and order of which is shown in Fig. 296. In making this arrangement, care was taken concerning

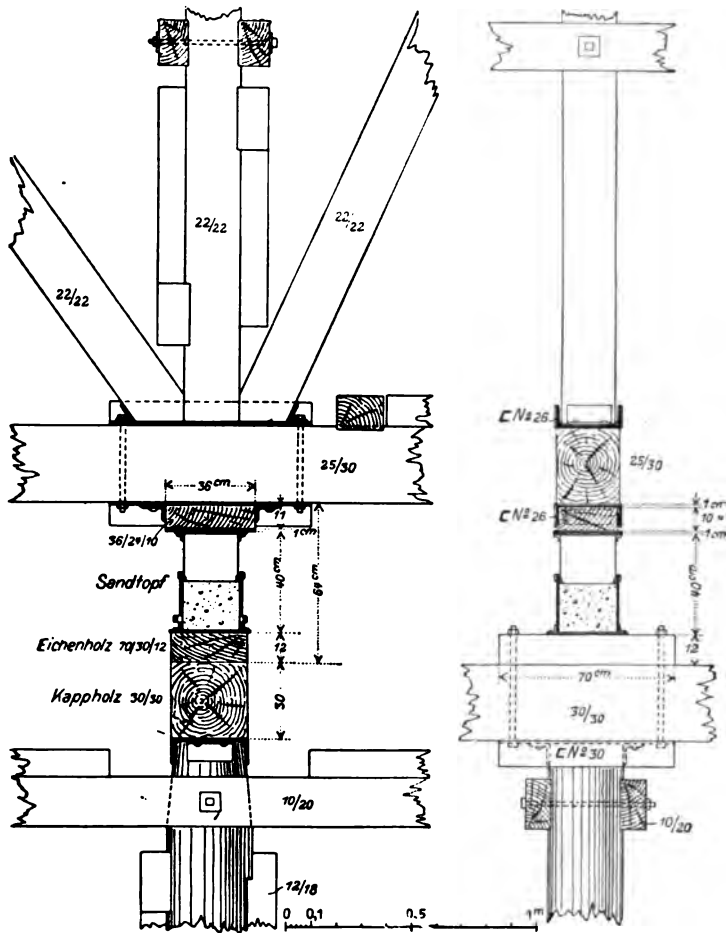

FIG. 299.—Detail of the forms of the Isar Bridge.

the centering that the largest sections, 1-6, usually covered a whole panel, with a small space left free at the ends of the panels over the posts, and also a small space next the hinge stones. For the order of concreting the small sections, 7-14, it was specified that those next the hinges should be done last, so that only light loads could come upon them, and thus prevent the development in them of a dangerous deformation. The last sections were those immediately adjacent to the hinge stones in the abutments. The arch was built with a mixture of 1 part Blaubeur Portland cement, 2 parts Isar sand, and 4 parts Isar gravel.

The forms for both main spans consisted of seven sections of the construction shown in Fig. 296. By this arrangement, it was insured that the supporting of the vertical loads from the concrete construction would be done most directly by the piles, so that the panels would be the only construction parts subjected to bending stresses. In this way deformation of the scaffolding was reduced to a minimum, and to this end, as far as precautionary measures could be taken, the posts and braces were not allowed to bear directly against the wood of the sills, that is, so that the latter would be overstressed in a direction at right angles to the fibers; 13 to 15 kg/cm² (185 to 213 lbs/in²) was assumed as a safe permissible stress on timber in that direction, and pieces of channel iron were employed to distribute the pressures of the posts and piles over the sills and cross-beams of the scaffolding. (Fig. 299.)



FIG. 300.—Highway bridge over the Isar near Grünwald. View of the left abutment.

Furthermore, sand boxes were employed, except for the first range from the abutment, where wedges were used. Compared with screw jacks, a saving in cost was effected; and further, the sand boxes offered the added advantage of a stabler support for the scaffolding, and, with sufficient caution and experience, as safe a form of centering was secured as with the average screw jack.

All foundations of abutments and piers were carried down by pumping to the rock (a kind of marl), which could be loaded to 5 kg/cm² (5 tons/ft²). The highest pier of the approach spans and the superstructure of the principal pier contained open spaces, limited in width by the reinforcement of the upper thoroughfare arches on these piers, and the condition that the floor beams were given sufficient bearing surface.

The bridge floor had a breadth of 8 m. (26.2 ft.) between the side rails, of

which 5 m. (16.4 ft.) was given to the roadway and 1.5 m. (4.9 ft.) on each side to a sidewalk. The floor sloped from the center pier in each direction on a 1% grade and was drained through the piers, over the abutments of each main span. The roadway was carried by a reinforced concrete construction, consisting of a reinforced slab 8.6 m. (28.2 ft.) wide and 20 cm. (7.9 in.) thick, which transferred its load to five longitudinal beams 25×40 cm. (9.8×15.7 in.) in section, which in turn were supported from the arch by reinforced concrete columns 4 m. (13.1 ft.) apart. The slab and the beams were designed as continuous members, in which the unfavorable assumption was made that the slab was free to move on the beams and the latter on the columns. For the calculation of the roadway construction the wheel load of a steam roller was critical. The reinforcements of the slabs and beams are shown in Figs. 303 and 304. Over the



FIG. 301.—View under the arch over the right-hand stream.

columns, the section of each beam was increased by haunches, so that the compressive stress on the underside, because of a large negative end moment, did not exceed safe limits. These haunches also reduced the shearing stresses.

The columns have a section of 40×40 cm. (15.7 in.) with the exception of those in plain sight at the sides of the bridge, which were given a T-section to improve their appearance, so that they had a breadth of 70 cm. (27.6 in.) on the outside. The reinforcement of the longest columns consisted of eight round rods 24 mm. ($\frac{15}{8}$ in.) in diameter, while the succeeding rows had eight rods of 22 mm. ($\frac{7}{8}$ in.), four rods of 24 mm. ($\frac{15}{8}$ in.), and four rods of 22 mm. ($\frac{7}{8}$ in.) diameter respectively; and the outside columns were reinforced with from eight rods 20 mm. ($\frac{13}{8}$ in.) to four rods 18 mm. ($\frac{11}{8}$ in. approx.) in diameter. In all columns, a tie spacing of 35 cm. (13.8 in.) was used, for the 7 mm. ($\frac{5}{16}$ in. approx.) round wires employed. The column steel extended about 40 to 50 cm. (16 to 20

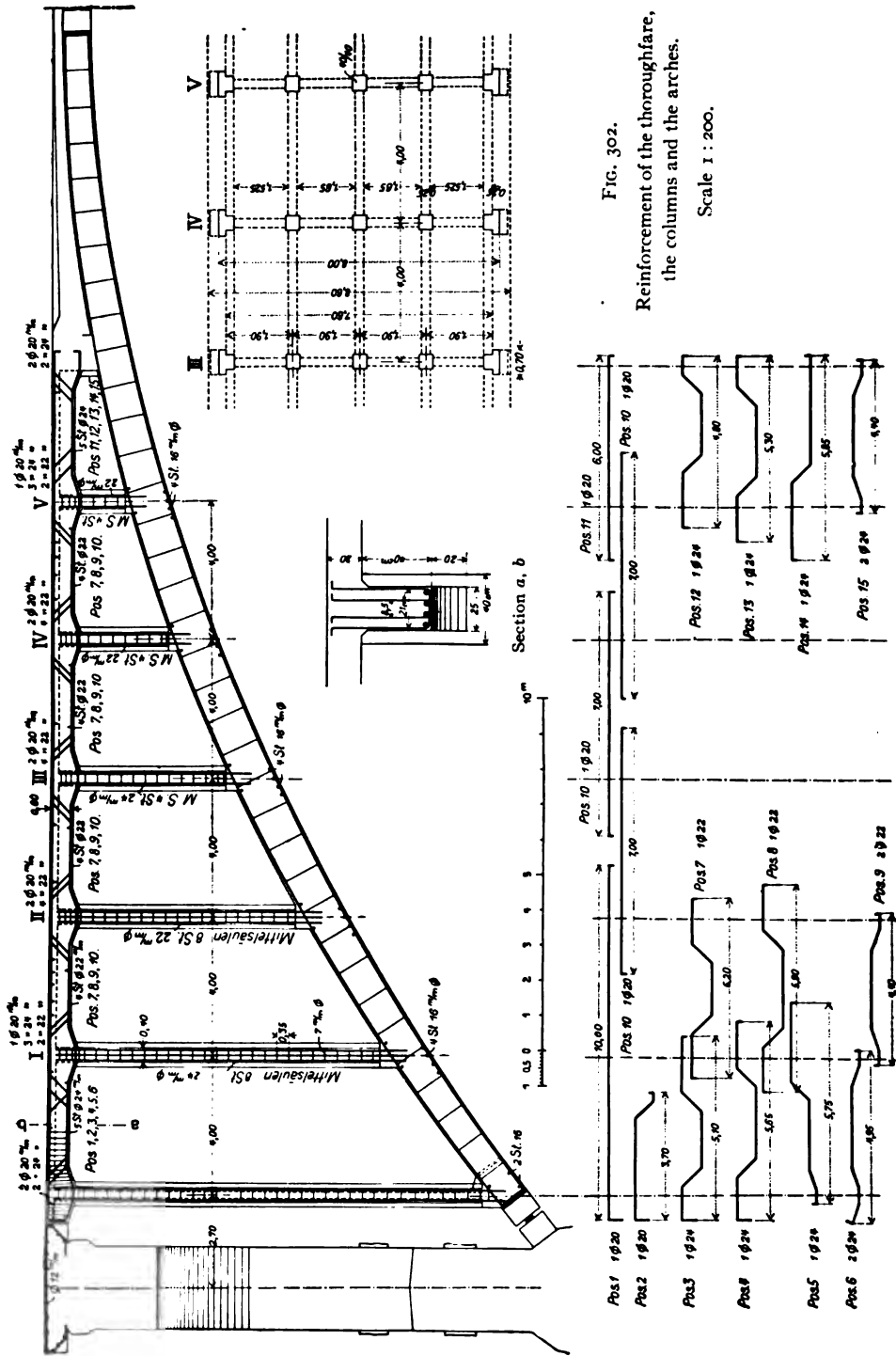

FIG. 302.

Reinforcement of the thoroughfare,
the columns and the arches.

Scale 1 : 200.

in.) into the arch concrete, and under each row of columns, the arch was reinforced laterally by four 16 mm. ($\frac{5}{8}$ in.) round rods below and two similar rods above, so as better to distribute the concentrated loads of the columns over the whole arch width. The last support over the abutments was built as a reinforced concrete wall, with openings, so as to provide the necessary lateral stability for the thoroughfare deck. Over the hinges at crown and abutments, expansion joints were provided in the deck construction, the joints being covered with sheet metal in the usual way.

The reinforced concrete construction over the 8.5 m. (27.9 ft) wide approach spans consisted of a deck slab and girders. Since the girders had the same spacing as those over the main spans, the slab was built exactly like that one. The beams were designed and constructed like simple, freely supported mem-

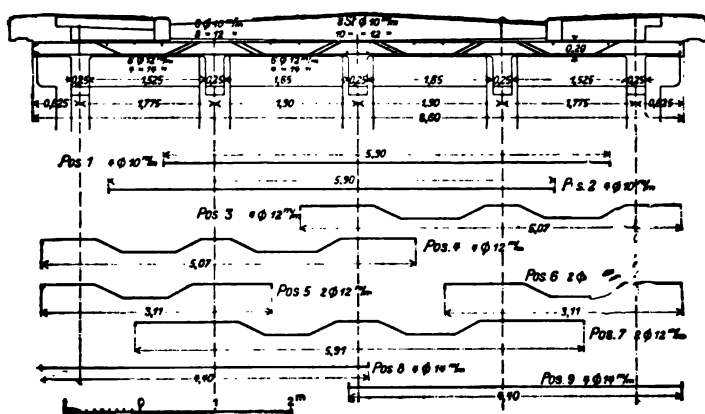

FIG. 303.—Reinforcement of the deck slab.

bers, so as to simplify the reinforcement which consisted of five round rods 36 mm. ($1\frac{3}{8}$ in.) and one rod 24 mm. ($\frac{1}{2}$ in.) in diameter. (See Fig. 304).

The architecture of the bridge is completely determined by its construction. With the exception of the center one, no pier is at all decorated. All concrete surfaces were left without manipulation, except one prominent ridge which was formed by a crack between the form boards. The railing was also constructed of concrete with open panels, without extra finish. The water-tight covering of the concrete slab which carried the thoroughfare consisted of a layer of asphalt, that of the arches being a water-tight cement coating.

When the centers were struck, the concrete was about three months old, and the whole dead load, including the pavement, was in place, so that the abutment pressure had exactly the direction computed for it.

The striking of the centers was so arranged that first, at a given signal, the sand boxes were opened under both middle sections beneath the center joint, and $\frac{1}{2}$ l. ($\frac{1}{2}$ pint) of sand allowed to run out. The opening was then closed, and a couple of blows struck upon the sand box which caused a settlement of a few millimeters. The same operation was repeated simultaneously on the next four rows of supports each side the center, and so on, to the third series, after which the process from the crown outward was repeated, and all except the last row was

lowered. A total of twenty-eight men with the requisite inspection force was necessary, each one being equipped with a wrench, an ax, a measuring vessel, and a mallet. Since the centering was itself strained elastically, only a very small deflection of the arch was observed. Since the deflection was not larger, the oak wedges next the abutments were also loosened.

When a lowering of the centers of 10 cm. (3.9 in.) under the crown had taken place, the deflection of the arch down to its final position was only 17 mm. (0.669 in.); the amount of the deflection of the arch measured to the centering was not uniform. This observed deflection measured to the centering amounted on the right span to 6.5 mm. (0.256 in.), and on the left one to 10 mm. (0.394 in.). Before and after the lowering, the width of the hinge opening

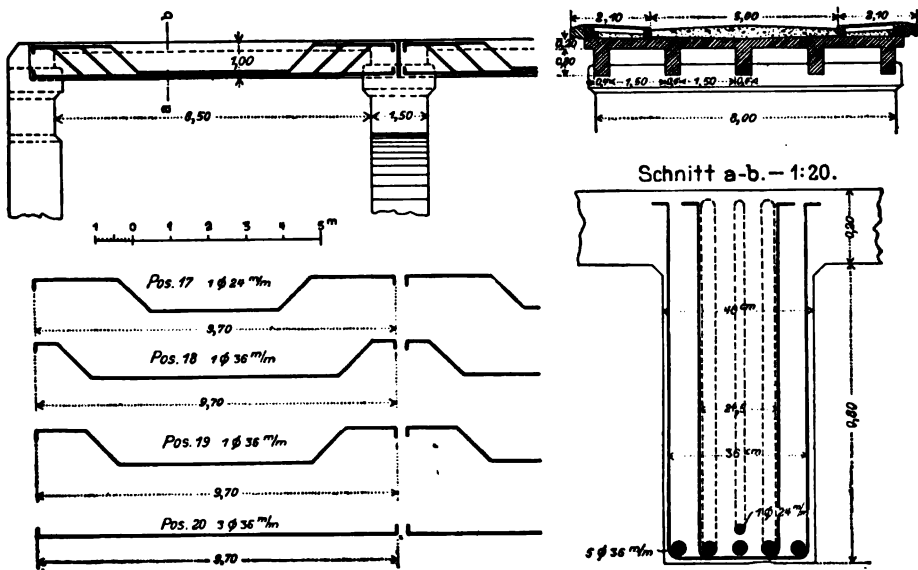

FIG. 304.—Thoroughfare construction between the piers on the left bank.

between the stones was measured, but a diminution of not more than $\frac{1}{10}$ mm. (0.004 in.) could be observed. Shifting of the foundations could not be ascertained with certainty with the instrumental arrangements at hand.

The computations for the deflection of the crown gave a satisfactory agreement with the measured amount, but also gave the conclusion that small deviations from the profile planned influenced the deflection considerably.*

The hinge openings of the arch were filled with cement mortar, so as to protect the steel hinges from rust. The mobility of the joint was maintained by a layer of asphalt, concreted into the center of the opening.

Since the actual cost of the bridge was only about 260,000 M. (\$62,000 approx.), it is demonstrated, as far as the Grünwald-Isar bridge is concerned, that arched bridges with a proper arrangement of reinforced concrete, and of large spans, can compete successfully with steel construction.

* See the description in the "Schweizerischer Bauzeitung," 1904.

In Fig. 305 is shown a smaller bridge with a hingeless arch and similar superstructure. The span is only 23 m. (75.4 ft.), the thickness of the arch at the crown being 35 cm. (13.7 in.), and at the springings 60 cm. (23.6 in.).

Besides the usual round rod reinforcement, plate or lattice girders are of advantage for the reinforcement of arch bridges, according to the Melan system. A description follows of the highway bridge over the Mosel Road at Wasserliesch, in which a shallow depth of construction was secured by arranging the reinforcement in the form of lattice girders.

In this bridge, which replaced a grade crossing, not enough space existed between the clearance required and the arch profile to erect a scaffold of the usual variety; even an iron structure to support the sheeting would commonly occupy the whole of the clearance space, which cannot usually be spared. Such metal



FIG. 305.—Nagold Bridge near Caln (Württemberg).

forms can only be employed to advantage when they may be used a large number of times in a more uniform structure.

Since an arch of the Monier variety was in this case out of the question, it was necessary to build the reinforcement so that it formed a supporting arch structure, upon which the forms could be hung in such manner that the space below the arch would be entirely free from scaffolding.

In Fig. 306 these steel supporting members are shown in detail. There are six members side by side in a distance of 0.9 m. (2.95 ft.), and they are secured against lateral tipping by a light horizontal connection. At the grades of the upper and lower layers was a network of longitudinal and cross wires 7 mm. ($\frac{5}{16}$ in.) in diameter, so as better to tie together the concrete.

The 3.5 cm. (1.38 in.) form boards were supported by 50×50×7 mm. ($2 \times 2 \times \frac{5}{16}$ in. approx.) angle irons, bent into a curve, and hung from the arch reinforcement by 15 mm. ($\frac{5}{16}$ in. approx.) screw bolts at intervals of 80 to 100 cm.

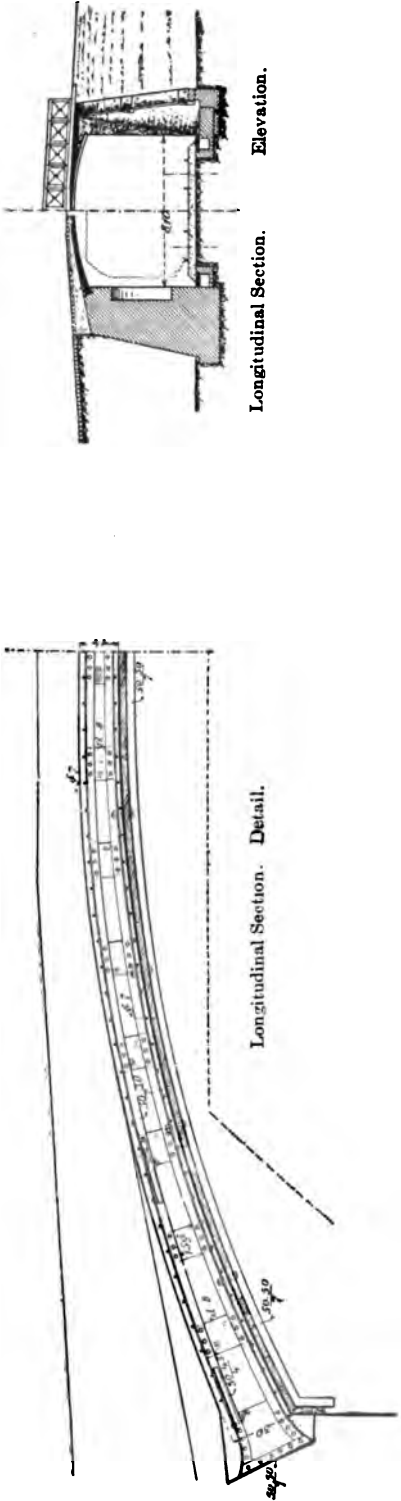

Test load of 400 kg/m² (82 lbs./ft.²) of railroad iron.

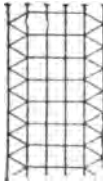

Scheme of Horizontal ties.

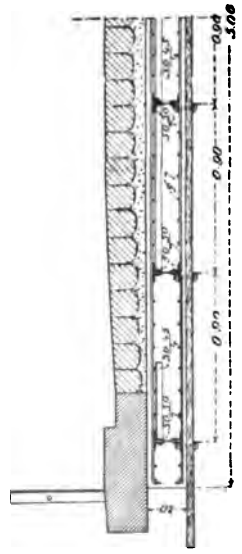

FIG. 306.—Bridge over the Mosel Line near Wasserliesch.

(30 to 40 in.). When the forms were removed, the bolts were withdrawn from the concrete matrix, and the holes so left were filled with cement mortar.

The steel arch-supports with fixed ends consisted of four angles $50 \times 50 \times 7$ mm. ($2 \times 2 \times \frac{5}{8}$ in. approx.), which were held together at distances of 50 cm. (19.7 in.) by plates. The ends were supported in their exact position by pairs of wedges. The calculation of the arch supports was made on the assumption that half the arch would be placed at one time, although this unfavorable loading could be obviated by commencing the concreting at both springings and at the crown at the same time.

In the foregoing type of construction, the concrete is loaded much less than in the usual reinforced arch, because the dead load is carried exclusively by the arch-supports, and the weight of the additional superstructure and of the live load is carried jointly by the concrete and the steel in proportion to their elastic deformations.

A greater advantage of the above described construction is that the removal of the forms can be done earlier (after about eight days) and without special care, whenever the concrete has become so hard that it can be left free between the steel ribs with safety. In the usual reinforced concrete arch the scaffolding should not be removed inside of about four weeks.

A bridge of the Melan type with three hinges is described with all details in "Beton und Eisen," No. III, 1903. In very large spans the girders, later to be concreted, give a guaranty for the maintenance of the proper form of the arch, which is of great importance, which can be secured with wooden centers only through considerable care. The girders always carry the whole or a greater part of the centering. When a wooden scaffold is employed in addition, it can be made much lighter than is otherwise necessary. A noticeable application of the Melan system was also made in the Chauderon-Montbenon bridge in Lausanne, where the high supporting scaffolding was omitted.

Newer Methods of Arch Construction in Reinforced Concrete.—In the foregoing, it was always assumed that the carrying part of the arch was rectangular in section. The serviceable application of reinforced concrete to arch-like structures of other shapes has lately been made. There may be mentioned:

(a) Reinforced arches of rectangular section, to which the thoroughfare is attached by hanging columns. In this case the thoroughfare can also act as a tie so that all horizontal shear is taken from the abutments. (See "Deutsche Bauzeitung, Zementbilage," Nos. 17 and 21, 1905). The best example of this kind is the railroad bridge over the Rhone at Chippis, with a span of 60 m. (197 ft.), in which the thoroughfare contains an expansion joint at the center of the span. (See "Schweizerisch Bauzeitung," 1907.)

(b) According to a method of construction already much used in Switzerland, by Maillart of Zürich, for reinforced concrete arch bridges, the side walls and the deck, which both consist of reinforced concrete, can be built in cantilever form decreasing in depth from the abutments to the crown. Since the combination of the several parts of this section is perfect, it can be employed in its entirety for carrying stresses. This construction appears to be specially adapted only for three-hinged arches. See "Schweizerische Bauzeitung," October 1, 1904.

(c) The arch can also be constructed of separate ribs of rectangular section

placed side by side, wherein spirally reinforced concrete affords extra strength. The thoroughfare is then supported by columns from the arch ribs. They are prevented from moving laterally by bulkheads or continuous slabs. If the latter are so built as to be flush with the upper layers of the ribs at the crown and with the lower layers near the abutments, this arrangement provides considerable resistance against deformations from normal stresses and from change of temperature.

(d) Spirally reinforced concrete is especially applicable to bridges and to arches consisting of separate ribs of octagonal or rectangular section, and also to truss-like members in the form of beams or arches. Banded concrete is, however, not yet well known, so that designers do hardly more than experiment with it. See Considère, "Essai à outrance du Pont d'Ivry," "Annales des Ponts et Chaussées," No. 3, 1903, and "Beton und Eisen," No. 1, 1904.

RESERVOIRS.

The Monier system, with its network of wire, is well adapted to the construction of reservoirs of all kinds. When a serviceable method of computing slabs was found, the thickness of walls and amount of reinforcement was determined with a proper margin of safety. Even earlier, an extensive application of reinforced concrete was made in the construction of various reservoirs for industrial purposes. Because of the satisfactory experience with these structures, reinforced concrete now occupies an even broader field in this line.

In the catalogue issued by Wayss and Freytag, in 1895, are found several examples of this application, explained by sketches. There may be mentioned: for paper mills,—bleaching cylinders, drip boards, chloride holders, acid tanks, mixing vats, settling basins; for breweries,—barley-soaking vats, drying arches, ice houses; for tanneries,—tan pits, etc.; for pulp mills,—similar parts to those in a paper mill, and so on.

If the tanks are circular, the horizontal reinforcement has to resist the tangential stress, the vertical rods acting only as ties. Long walls of rectangular tanks are rigidly connected to the bottom, which is always constructed as a reinforced slab monolithic with the walls. In that case the largest stresses are in the vertical reinforcement. The water tightness is obtained by a water-proof cement coating on the inside.

The cylinders are protected from the injurious influence of acids by a covering of porcelain tile. The construction of bleaching cylinders with brick or mass concrete walls has proven unsatisfactory, since the heating through of the relatively thick wall takes too long. When the hot paper stock is introduced, the inside is warm and the outside cold, and cracking takes place. Cylinders of reinforced concrete do not possess this disadvantage, since with the thinner walls, a quicker equalization of temperature results, and furthermore, the reinforcement resists the stresses produced.

Several constructions adapted to the needs of special industries will be described in detail. The largest water supply reservoirs may be built of reinforced concrete in various ways. Either the walls may be made of mass concrete or masonry,

and reinforced concrete used for roof and partitions; or bottom, walls and top may all be built of reinforced concrete.

An example of the first kind, which is most often employed, is shown in Fig. 307. The top, when built in reinforced concrete, offers economic advantages over the usual arched construction only when the price of gravel and its transportation cost is high.

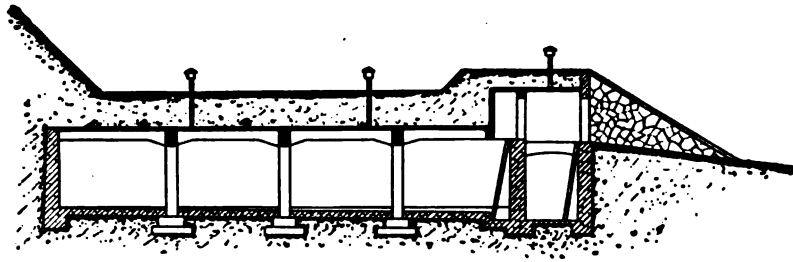
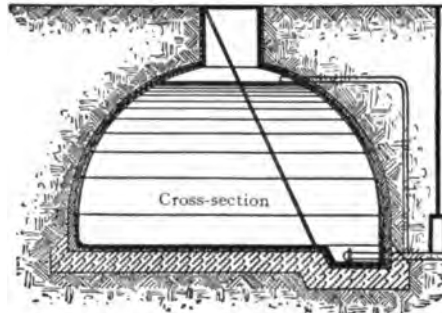

FIG. 307.—Water reservoir with reinforced concrete cover.

Reservoirs entirely of reinforced concrete, up to about 300 cu.m. (79,250 gals.) capacity, are usually of hemispherical or cylindrical form, with a dome-shaped top. Fig. 308 shows a section through a hemispherical reservoir, such as are commonly built for small water supplies. With graphical methods of calculating domes, the various stresses to resist loads in the directions of the meridians and parallels may be found, and the reinforcement correspondingly determined.



Cylindrical reservoirs with flat dome-shaped tops must be provided with a heavy tension ring to resist the horizontal shear of the dome and transfer it to the cylinder. Fig. 310 shows a water reservoir 7 m. (22.9 ft.) in diameter, reinforced with round rods and having I-beams as an inclosing ring, and with a top constructed to resist heavy street traffic.

To construct of reinforced concrete the whole of a large reservoir of elongated rectangular plan is not always as economical as a well built reservoir of mass concrete. Under certain circumstances the former allows, however, a better employment of the ground area available and is to be recommended with expensive gravel and sand. In Fig. 311 is shown such a reservoir, of 4000 cu.m. (1,057,000 gals.) capacity, for Brussels. The side walls, which withstand a water head of 2 m. (6.6 ft.) were reinforced concrete 12 cm. (4.7 in.) thick, spanning between the top and the bottom. The beams in the top form rectangular panels, so that the deck slab was reinforced in two directions.

Water towers are well adapted for construction in reinforced concrete, the substructure as well as the tank being of the same material. The structural

members may be placed on the outside and thus add to the architectural appearance.

Figs. 312-313 show a cylindrical tank with dome-shaped bottom, supported on masonry walls. The shear produced by the arched form of the bottom was resisted by eight round rods 40 mm. ($1\frac{5}{8}$ in.) in diameter, forming a ring.

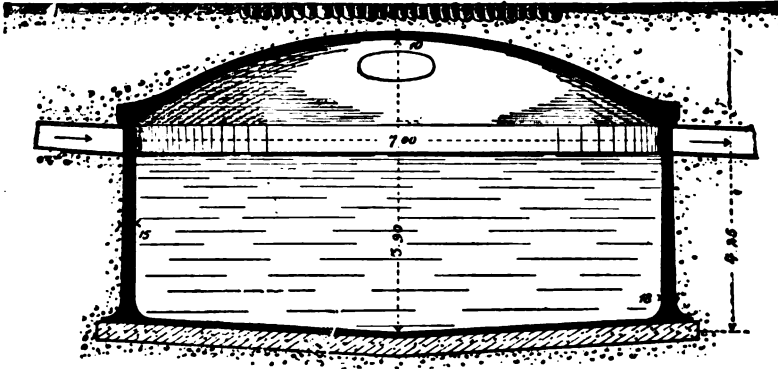

FIG. 309.—Cylindrical water reservoir with dome-shaped top.

In Fig. 314 is shown the reservoir of the Grosswartenberg water supply system. The tank overhangs the supports, because of the interior construction. The insulating wall is also constructed of reinforced concrete. The details of construction, and all the arrangements are shown in the figure.

Figs. 315-316 show a vertical section and general view of the water tower in Rixensart, in which the substructure consists of a pleasing reinforced concrete frame, the panels of which are filled with brickwork.

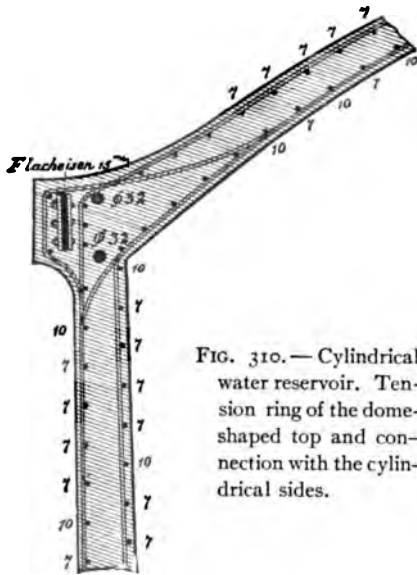

FIG. 310.—Cylindrical water reservoir. Tension ring of the dome-shaped top and connection with the cylindrical sides.

As far as the tensile stresses involved are concerned, gas receiver frames can profitably be constructed of reinforced concrete. For the upright guides, special concrete piers must be built, both outside and in connection with the receiver walls. See Fig. 317.

In the cylindrical walls of such a tank, besides the circumferential stresses, bending stresses in a vertical direction exist, developed because the cylindrical walls are prevented by their rigid connection with the bottom from assuming the deformation corresponding to the circumferential stresses, that is, of increasing in diameter. Since the cylinder is prevented to the greatest extent from enlarging near the base, vertical tensile stresses appear there on the inner side, while they act near the top on the outer side. These vertical stresses are cared for by

vertical steel near the inner and outer faces of the cylindrical wall, which must be strongly connected with the bottom. Concerning an investigation into the method

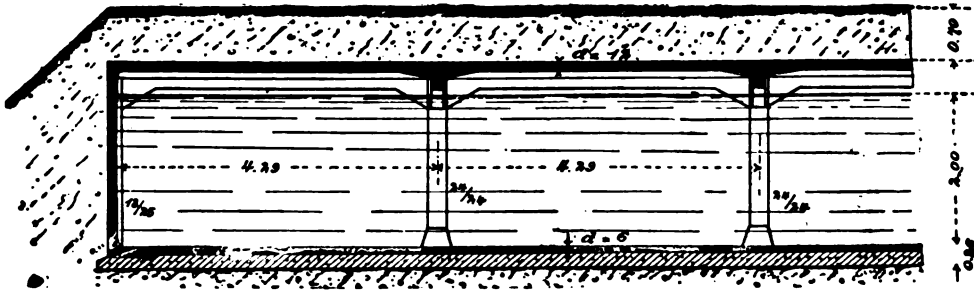

FIG. 311.—Water reservoir of 4000 m³ (141,275 ft³) capacity for Brussels. Cross-section.

of calculating these bending stresses by Reich, see "Beton und Eisen," 1907, No. 10.

Silos.—Silos are bins for certain dry materials, such as grain, coal, cement, ore, broken stone, etc., in which, because of their shaft-like arrangement, the

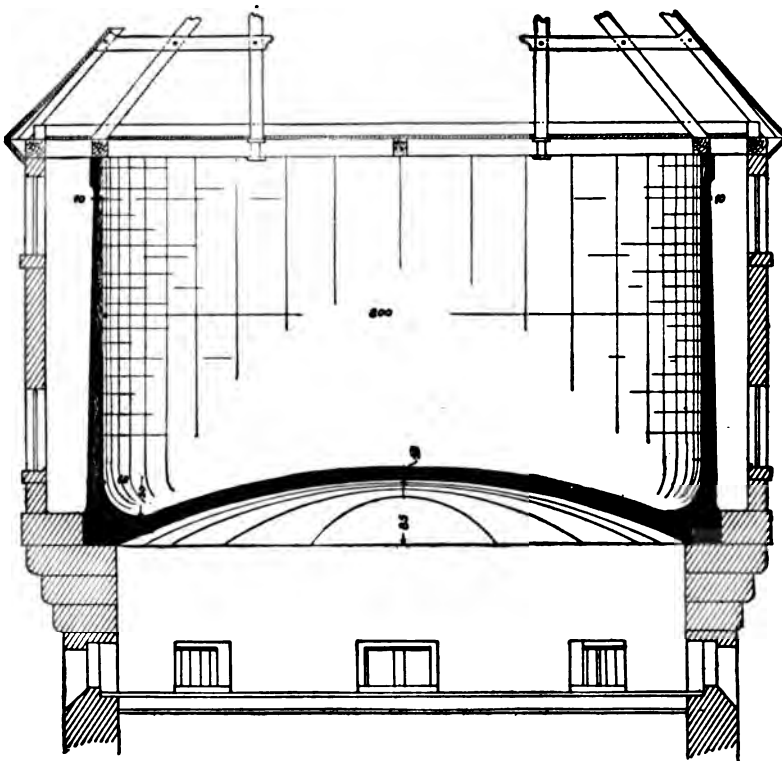

FIG. 312.—Cylindrical tank with dome-shaped bottom.

material which was received above, can be extracted when necessary from the lowest point of the bin. In this connection may be distinguished large silos

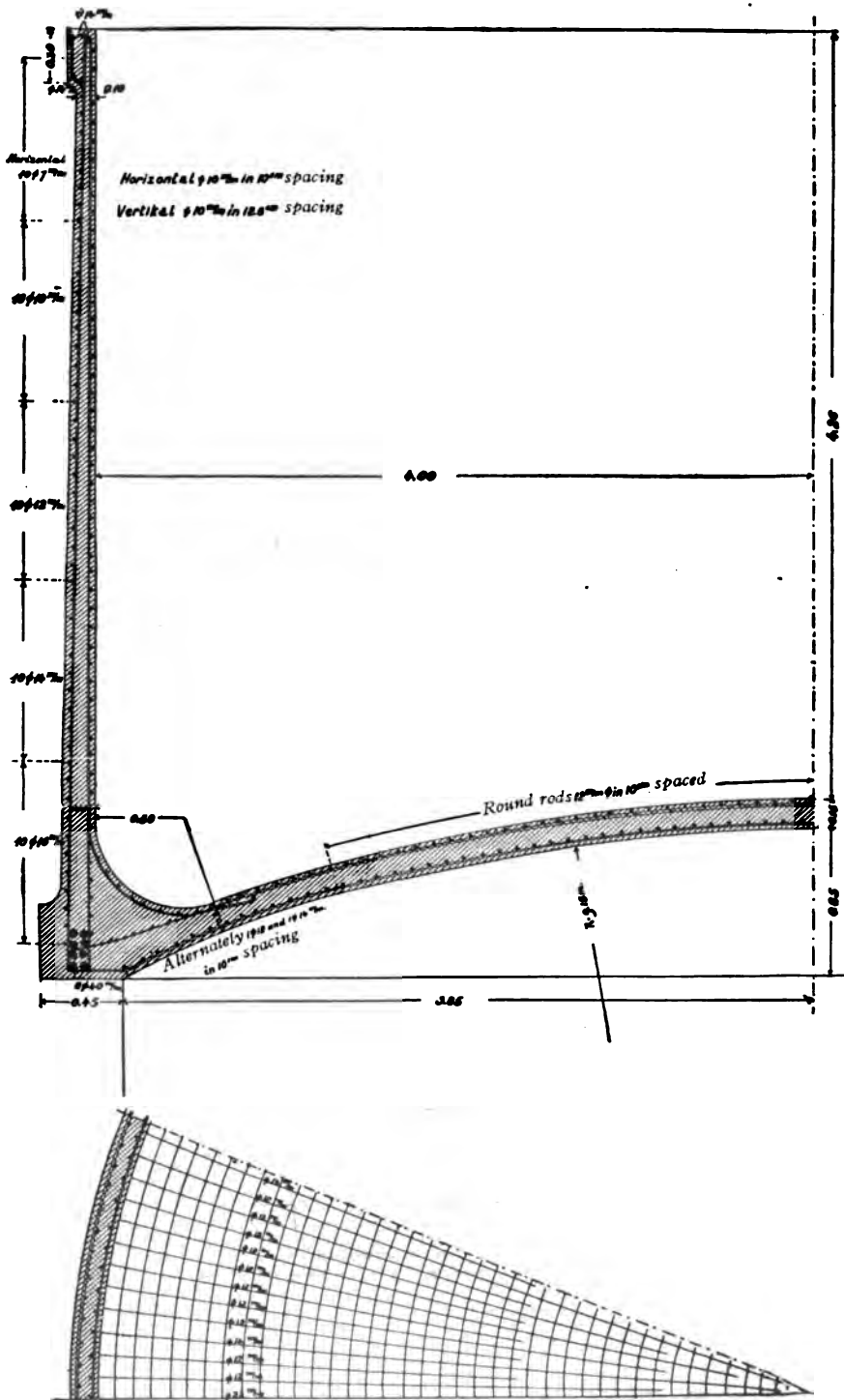

FIG. 313.—Cylindrical tank with dome-shaped bottom. Detail of reinforcement.

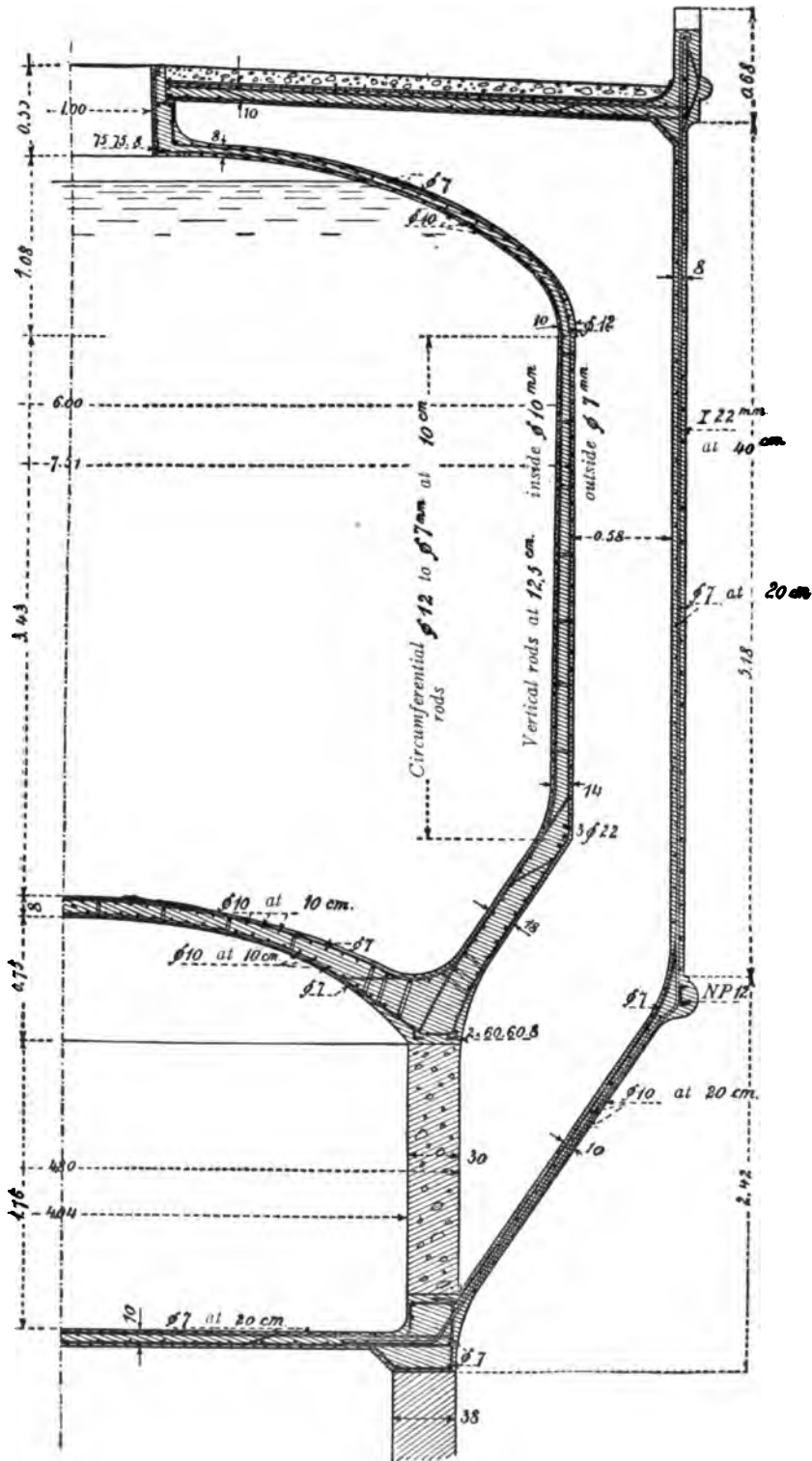

FIG. 314.—Grosswartenberg water tower.

without separate partitions, or such as are relatively large in area with respect to their height; and cellular silos, or silos consisting of compartments of rectangular, or better, of square, round, or hexagonal section.

Examples of the first variety, without interior division walls, are the ore bins for the Burbach smelters, the general arrangement and details of which are given in Figs. 318 to 320. The foundation of these bins consists of a continuous reinforced concrete slab 70 cm. (27.6 in.) thick, which distributes the load uniformly upon the soil at a stress of 1.5 kg/cm² (1.5 tons/ft²). Since the columns were spaced 3.33 m. (10.9 ft.) apart in both directions, reinforced concrete beams

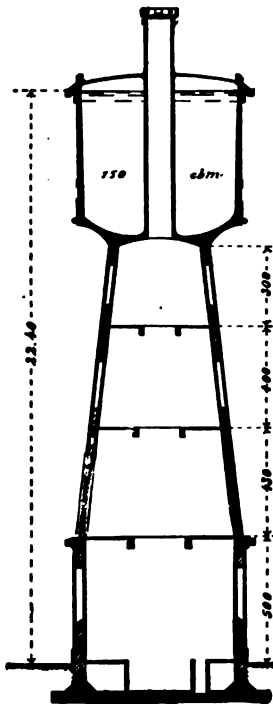

FIG. 315.—Water tower in Rixensart.



FIG. 316.—Water tower in Rixensart.

were built into the foundation slab in each direction under the rows of columns, the square panels between being correspondingly reinforced. The 60×60 cm. (24×24 in.) openings in the funnel-shaped square panels in the bottoms of the bins were supplied with slide valves. Beams also extend in both directions over the rows of columns. The outside walls 6 m. (23.6 ft.) high, were anchored to the beams in the bottoms of the bins by ribs 25 cm. (9.8 in.) thick. Between them the outer wall acts as a continuous reinforced concrete slab. The top of the wall is stiffened by a somewhat thicker rib. Three railroad trestles enter the bin on 25 cm. (9.8 in.) thick supporting walls, 6.66 m. (21.8 ft.) apart, carried by the lower columns. The trestle stringers are continuous reinforced concrete girders.

Spaced 26.4 m. (87.2 ft.) apart are expansion joints through floors and walls. All exposed edges of ribs, supporting walls and columns are protected against wear by channel and angle irons.

A smaller silo, without interior partitions, is shown in section and plan in Fig. 319. The coal in storage can be discharged directly into the boiler room through several openings. The walls carry the lateral pressure of the stored material horizontally to the columns which are tied together by the roof, and between the funnels by cross-beams, 45×45 cm. (17.7 in.) in section.

In the silo for the Odenwälder copper works (Fig. 321) a trestle of the kind described above is built over the several pockets. The latter are of an elongated

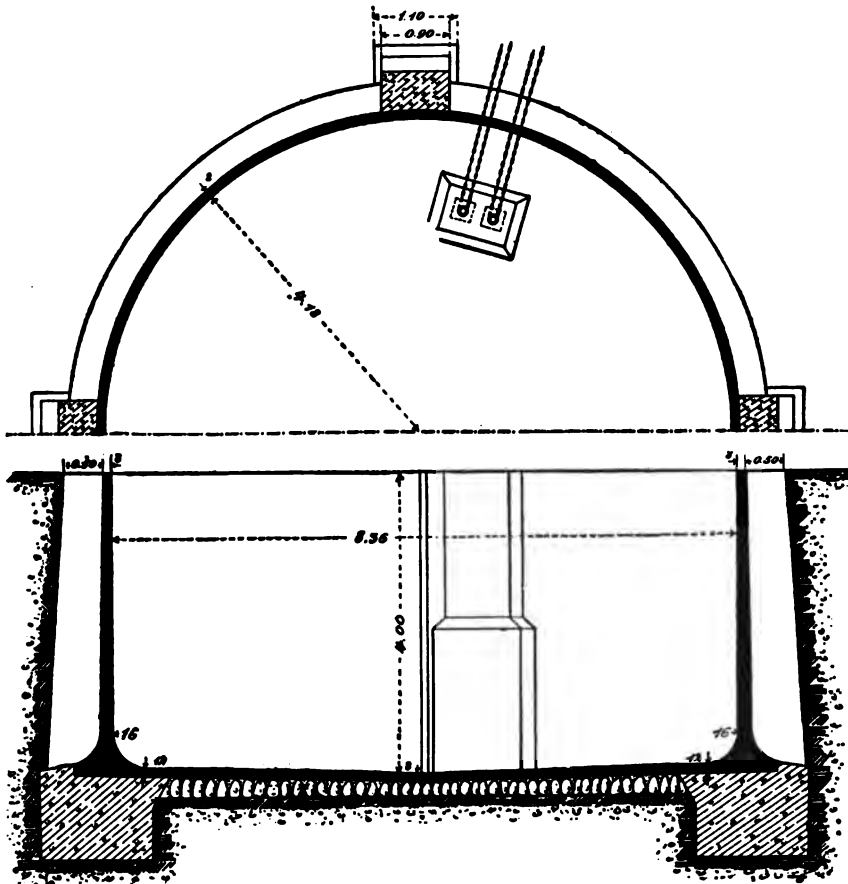

FIG. 317.—Gas holder of the Jagstfeld Railroad Station.

rectangular form, and make a row along the length of the building serving for the storage of crushed porphyry of various sizes of particles. The building is described at greater length by the author in "Beton und Eisen," No. 1, 1903, with details, to which reference should be made.

The malt silo of the Löwen brewery in Munich, contains cells 3.5×3.75 m. (11.5 \times 12.3 ft.) in plan, 16.5 m. (54 ft.) high, with a capacity of 2200 hl. (6242 bushels). The points of intersection of the walls are supported by reinforced concrete columns, which carry the load to a continuous foundation slab, 1 m. (39.4 in.) thick, so that the foundation pressure is only 2.5 kg/cm^2 (2.5 tons/ft²).

The outer walls show pleasing reinforced concrete ribs, the panels between which are filled with brickwork. Between the latter and the outside silo walls an

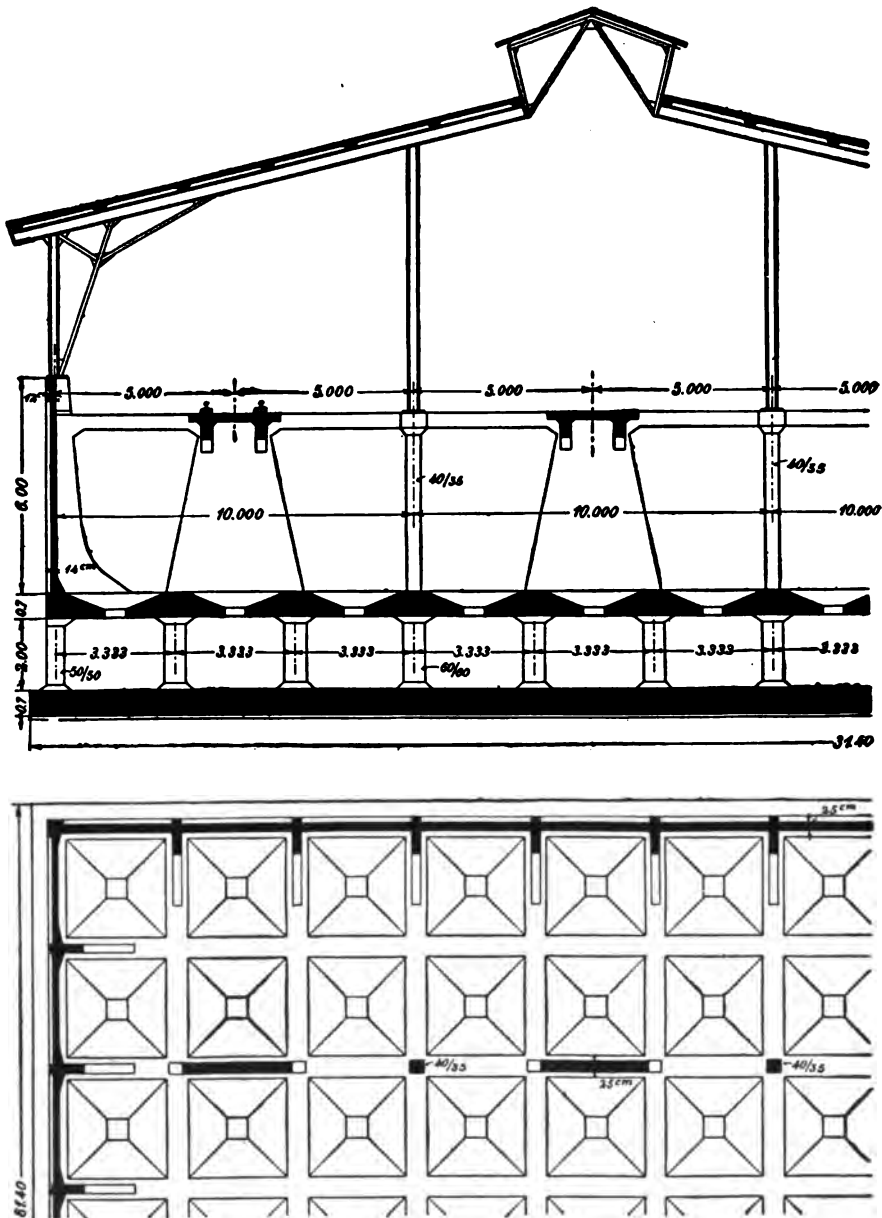

FIG. 318.—Section and plan of the Burbach ore bins.

insulating air space is left. The silos are emptied by screw conveyors located at the level of the bottoms of the bins, in the lateral passage (Fig. 322).

While in usual structures the silo funnels are constructed simply as hanging pyramids, the large ones in the saw-dust bins of the pulp mill shown in Fig. 323

are supported by a T-beam deck, and stiffening walls are erected upon this. The outside walls 8 m. (26.2 ft.) apart are also tied together by an anchor beam in the center of each panel between the cross walls. The principal reinforcement of the outside walls runs vertically between the two horizontal wall beams. Fig. 324 gives a view of these silos, which are erected on a high brick substructure. Arched beams are used for the roof girders.

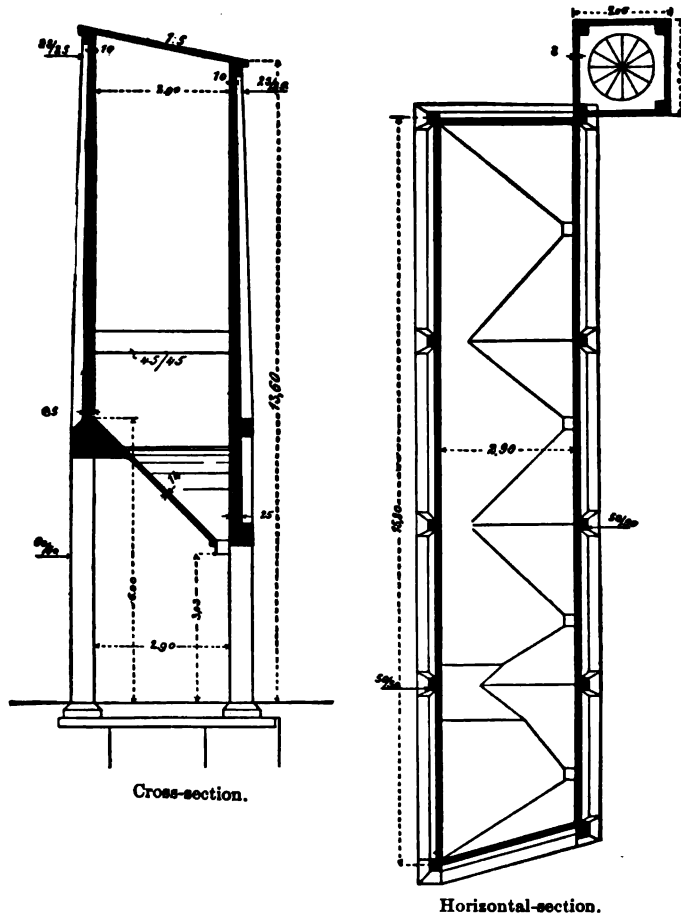

FIG. 319.—Coal pocket in Kirn.

Examples of cellular silos with very large pockets of 6.7×8.5 m. (21.9×27.9 ft.) ground plan, are those of Figs. 325 and 326, showing the coal pockets of the Volklingen smelters. In this case it was essential that the underside of the floor should be absolutely flat, making it necessary that the beams and girders extend above the slab. The silo rested on a continuous reinforced concrete foundation slab. Details of the girders are shown in Fig. 326.

Reinforced concrete can doubtless be considered the best building material for silos; since, aside from its fire-proof qualities, the reinforcement of the walls affords at the same time the best anchorage for them. It so happens most advantageously that both functions of the horizontal reinforcement in the cell

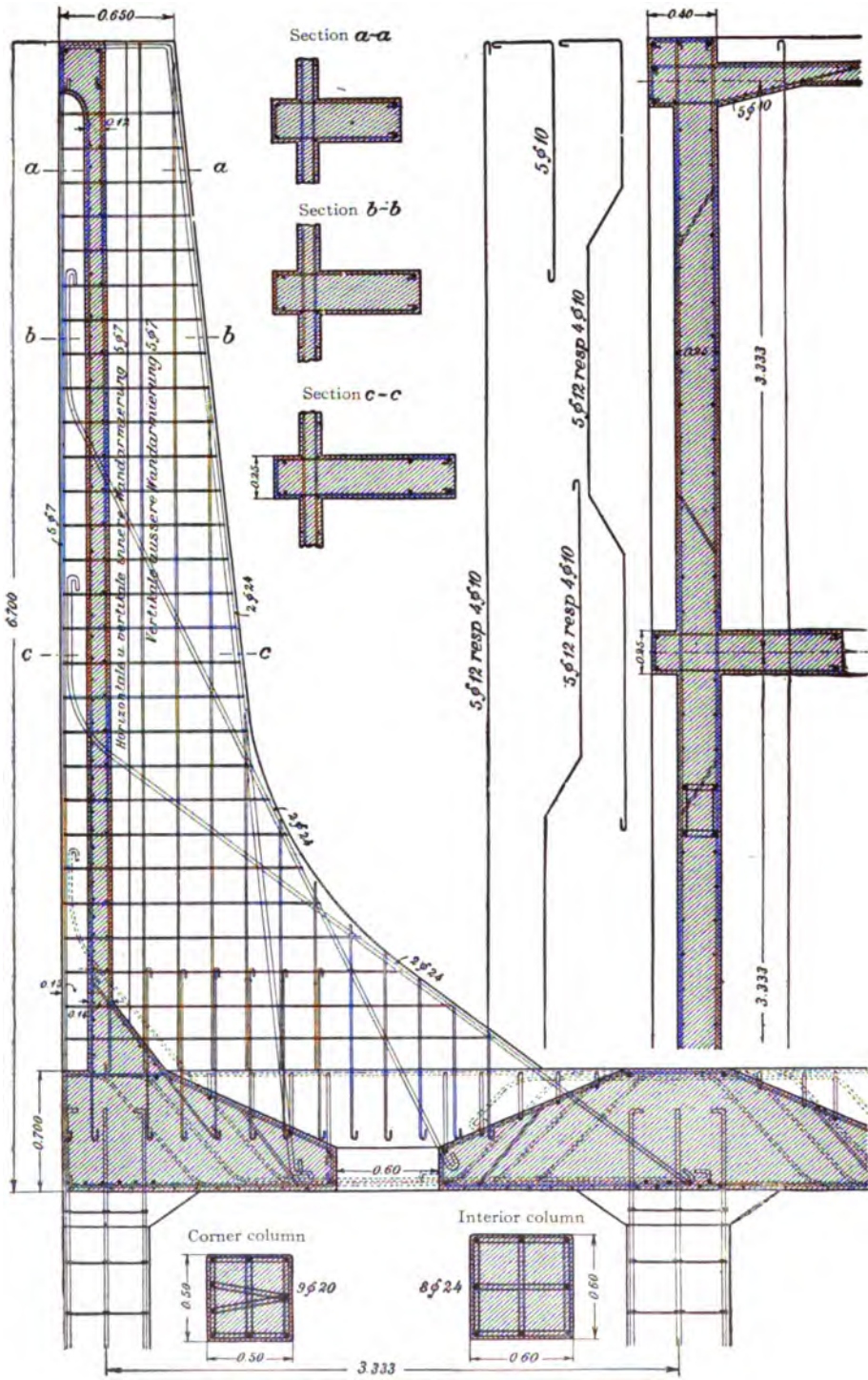

FIG. 320.—Burback ore bins. Details of reinforcement.

walls are not necessary at the same time; the anchorage stresses being greatest with simultaneous filling of adjacent pockets, when, however, the bending stresses are nill; and with maximum bending stresses, as when a single pocket is filled, the anchorage stresses diminish one-half. As to the bending with axial tension, which occurs in this case, see page 127. The constructive excellence of reinforced concrete has further been proved, because, during the past year, in the construction of a large silo foundation, an additional application has been found. The following is a single example of silo construction executed by Wayss and Freytag this year and last.

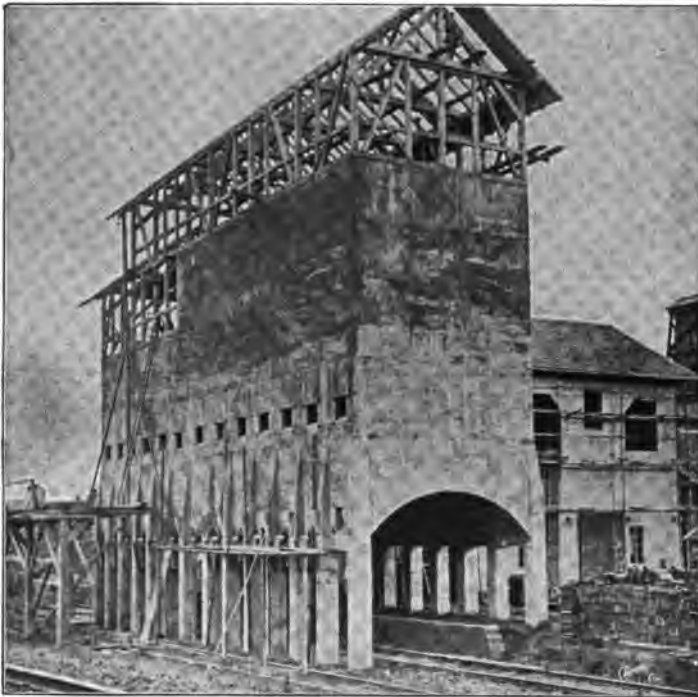

FIG. 321.—Reinforced concrete silo for the Odenwäld Copper Works at Rossdorf.

Fig. 329 is a view of the reinforcement in the funnel of the silos of seven hexagonal pockets 16 m. (52.4 ft.) high, for the Alsen Portland cement works in Itzehoe.

Since the walls of square cells are to be considered as fully restrained at the corners when adjacent pockets are filled, the moment at the centers of panels is $\frac{pl^2}{24}$, and in the corners $\frac{pl^2}{12}$. For this reason the walls should be twice as thick at the corners as at the centers. In Fig. 327 is shown the reinforcement of the walls for a silo with 44 square cells of 4×4 m. (13.1 ft.) ground plan for the Alsen Portland Cement Works at Itzehoe. It is seen that the wall thickness is doubled at the corners. The outside walls are covered with brickwork, with an insulating air space between it and the reinforced concrete walls, and its support

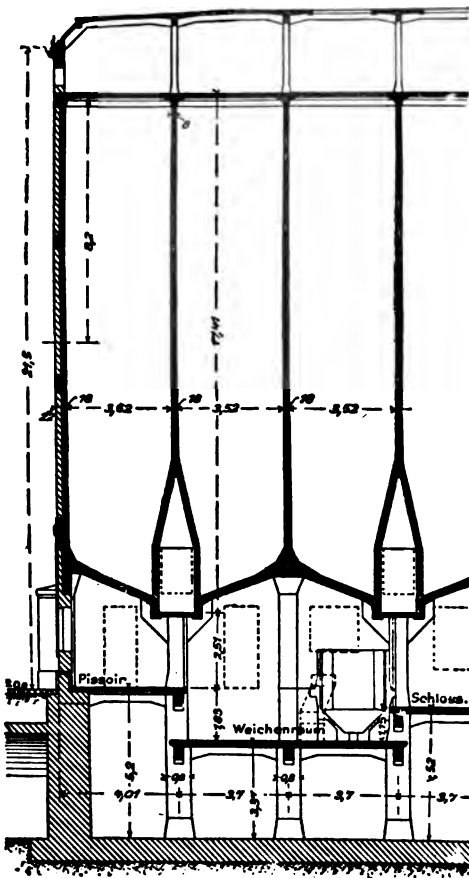

FIG. 322.—Lower Brewery, Silo, Munich.
Half longitudinal section



FIG. 324.—Sawdust bins of the Waldhof Pulp Mill.

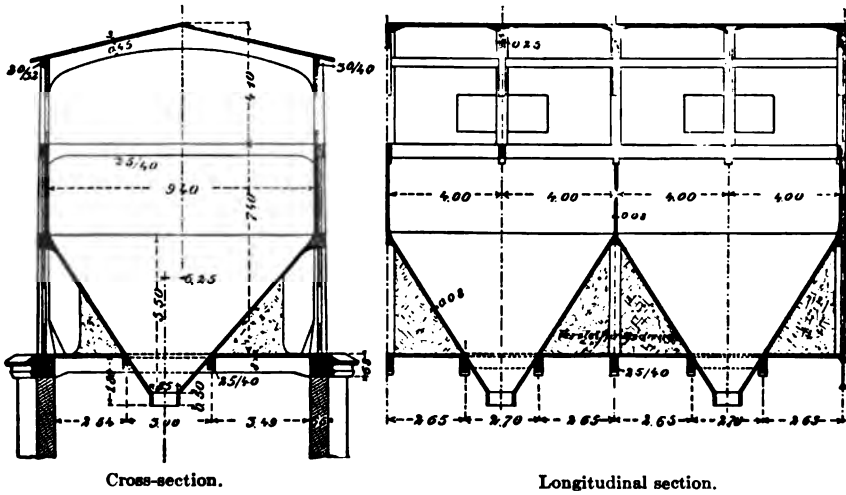

FIG. 323.—Sawdust bins of the Waldhof Pulp Mill.

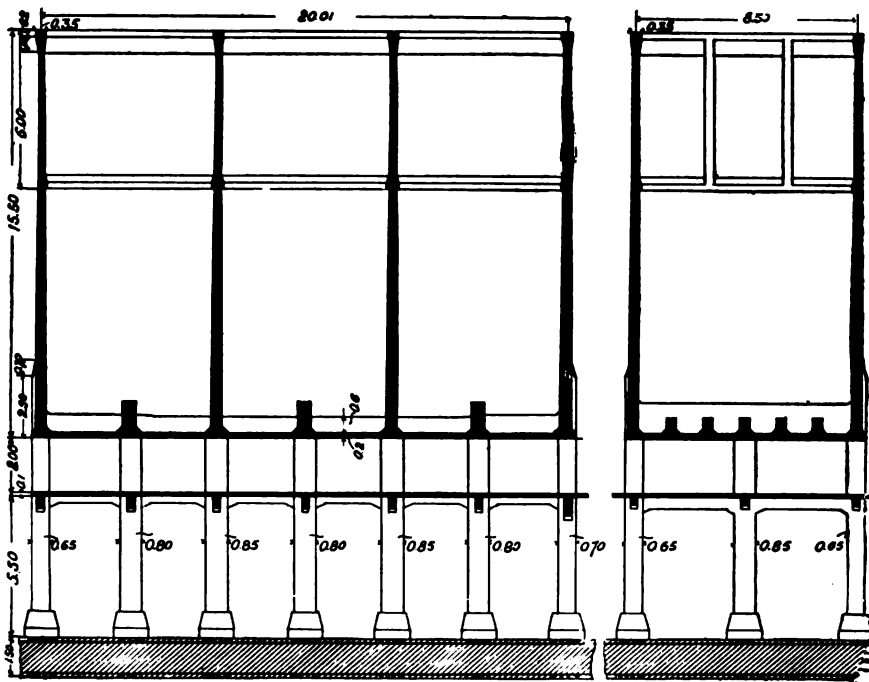

FIG. 325.—Välklingen coal pockets.

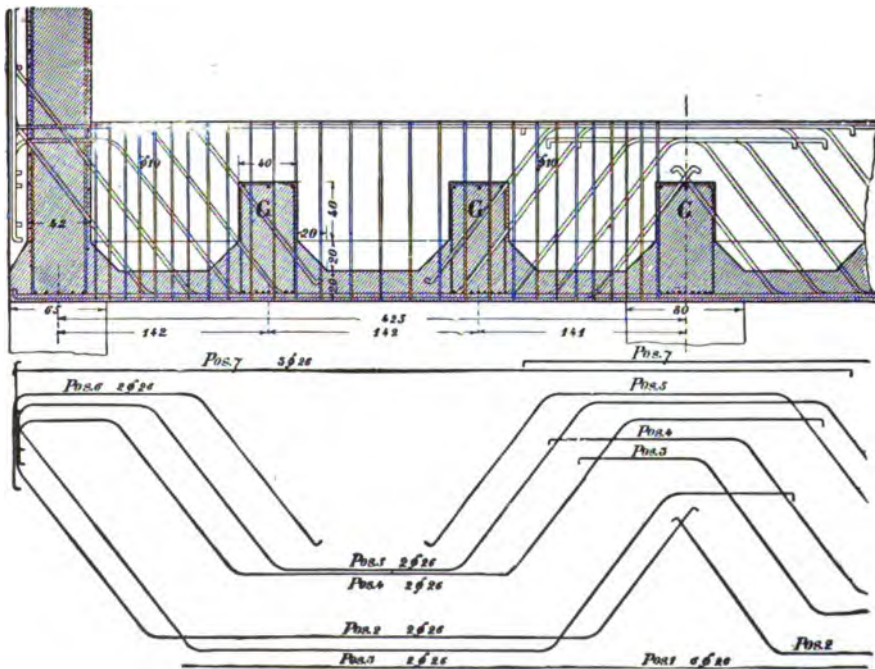

FIG. 326.—Välklingen coal pockets. Details of the rods in the girders in the bottoms.

is obtained at certain levels from projecting reinforced concrete ribs monolithic with the concrete wall.

A view of two silos, each with seven hexagonal cells, is shown in Fig. 328. The bending moments in them are relatively less than in square pockets.

Smelters require a special variety of silo, called an ore pocket, the cells of which

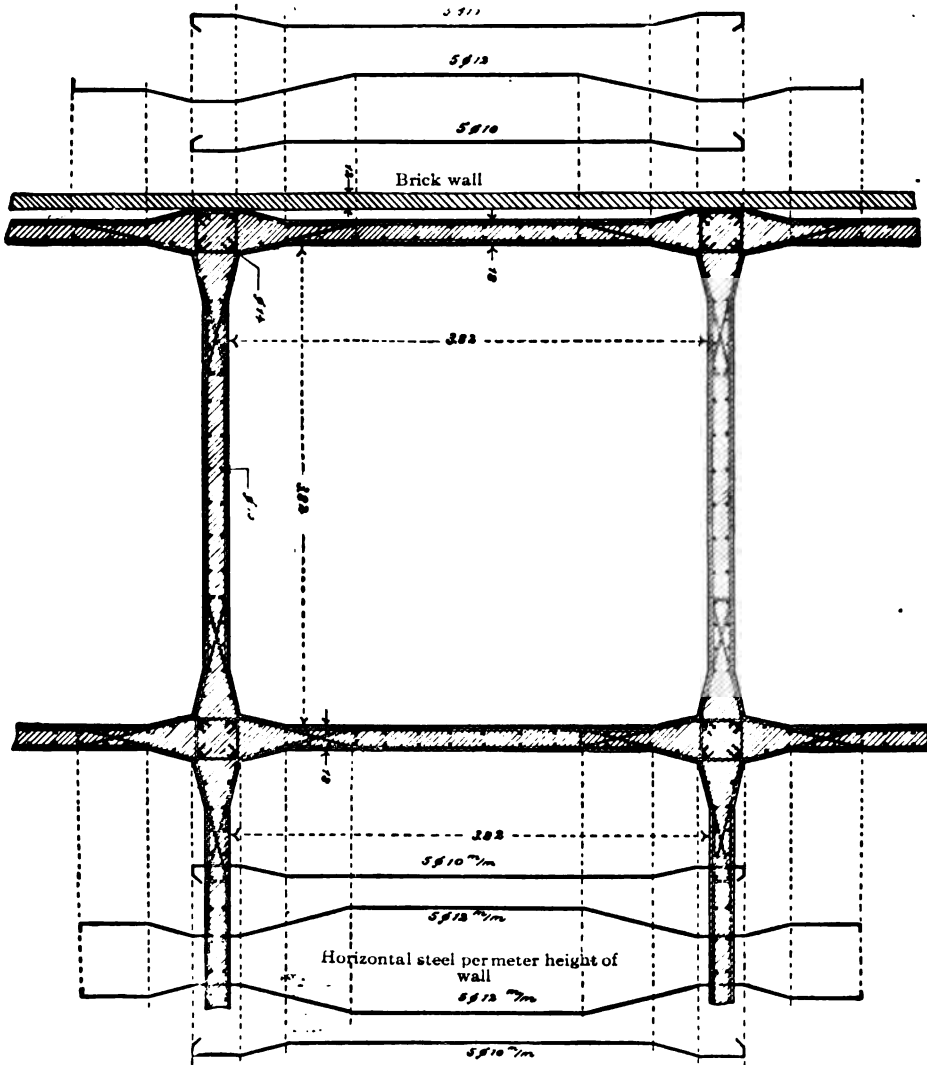

FIG. 327.—Cement bins in Itzehoe. Detail of the cell reinforcement.

are not arranged in two or more separately entered groups. In Figs. 330 and 331 are given a cross-section and a longitudinal section of such an ore pocket for the Mosel smelter at Maizière, which is 178 m. (584 ft.) long. The sloping floor slabs were supported by very heavy cross-beams, upon which also rested the reinforced concrete columns supporting the three railroad trestles. Because of the great length of the construction, four expansion joints were installed. For

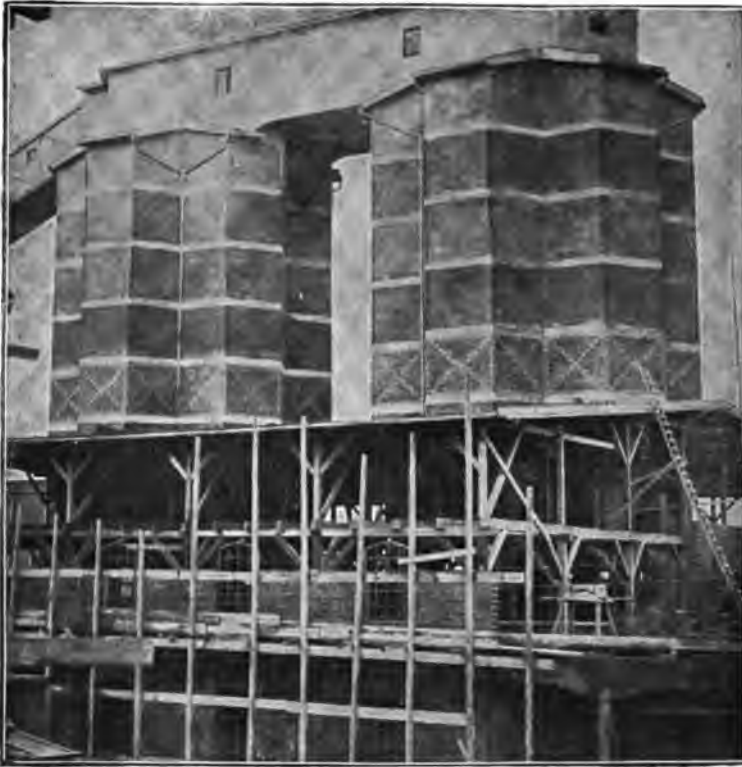

FIG. 328.—Cement bins for the Alsen Portland Cement Co., Itzehoe. 14 hexagonal cells.

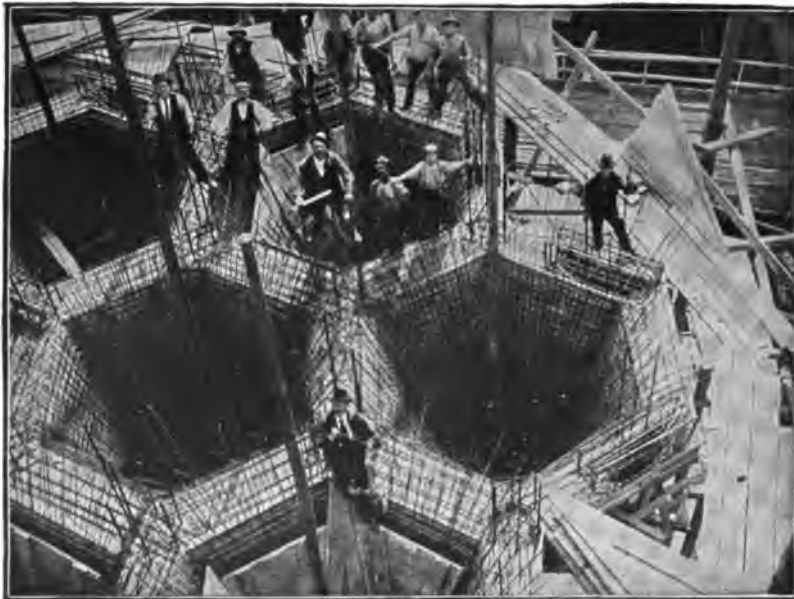

FIG. 329.—Cement bins. Reinforcement of the funnels near the hexagonal cell bottoms.

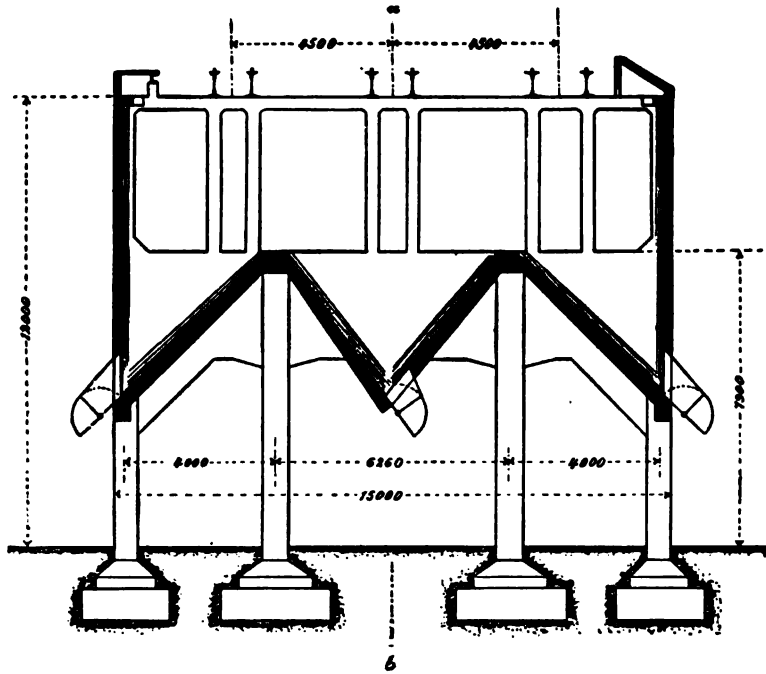

FIG. 330.—Ore pocket for the Maizière Smelter. Cross-section.

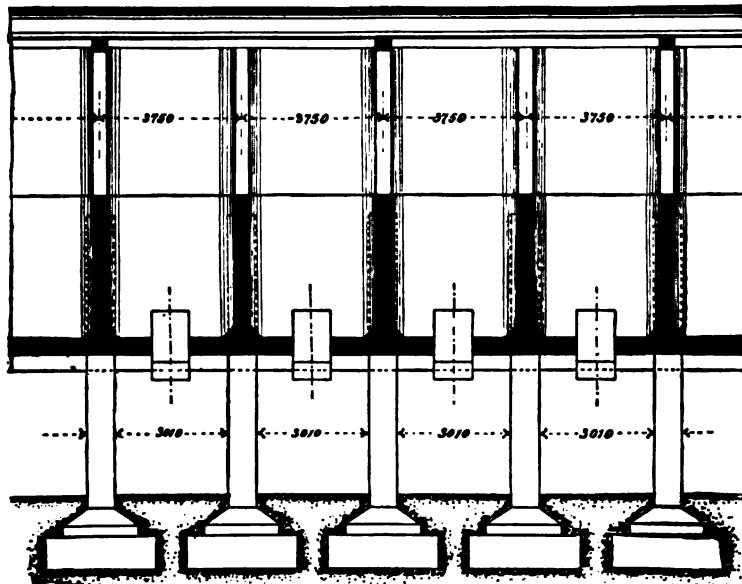

FIG. 331.—Ore pockets for the Maizière Smelter. Longitudinal section.

these the arrangement was made of providing double columns and girders, the two systems built so as to touch one another. The girder reinforcement was



FIG. 332.—Maizière ore pockets. 178 m. (583 ft.) long.



FIG. 333.—View beneath the Maizière ore pockets.

especially designed to resist shearing stresses, special bent rods being employed, while the upper and lower rods were not diverted.

In the lower part, the longitudinal walls spanned directly from one girder to

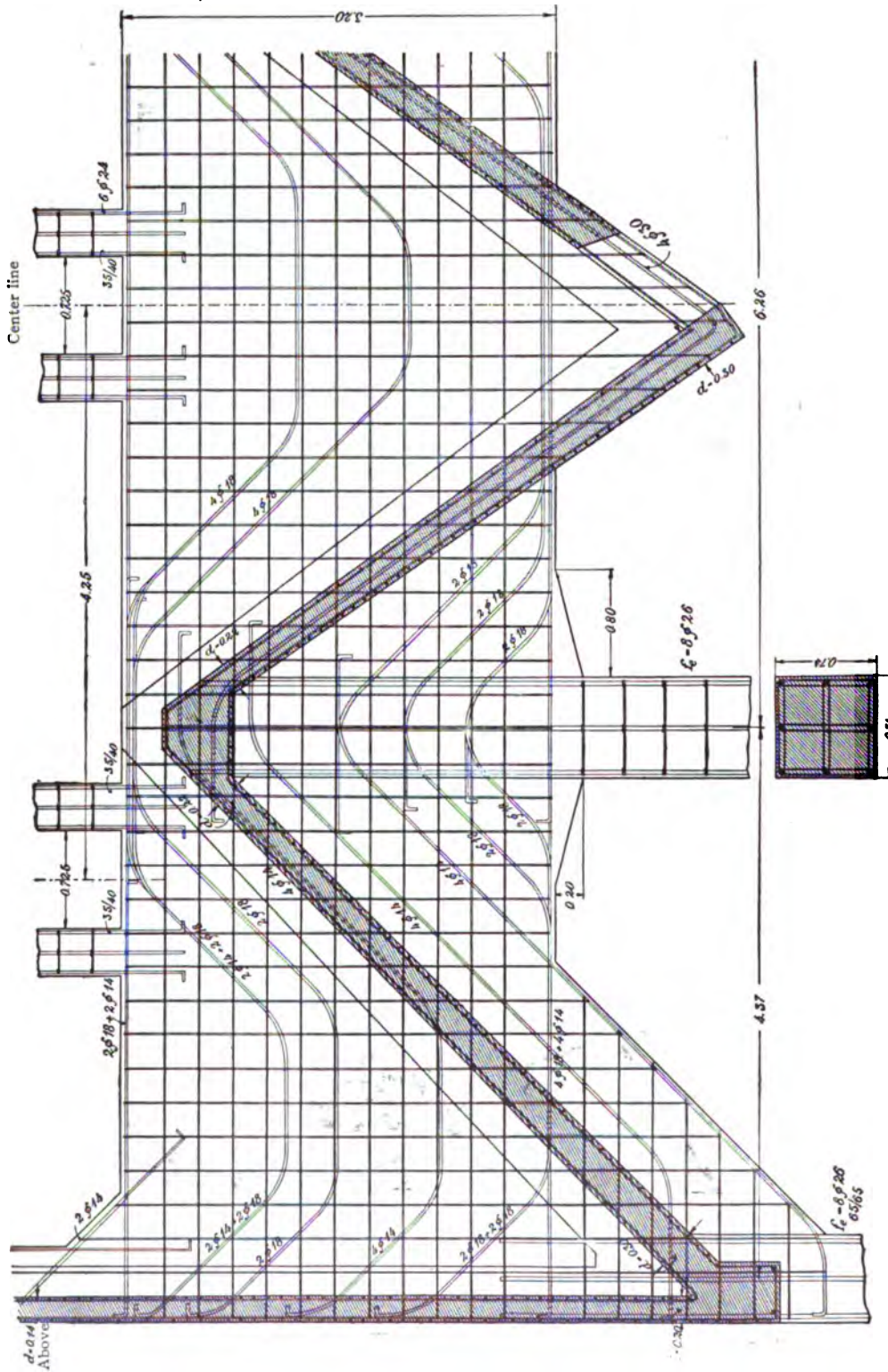

FIG. 334.—Maizière ore pockets. Reinforcement in the cross beams.

the next, while in the upper, open part they extended between vertical reinforcing beams which were anchored together by tie-beams at the tops. The column arrangement is not regular, being made to conform to the requirements of the necessary lateral passages which required a peculiar modification from that used in the usual sections of silos.

The emptying of the pockets takes place at the lowest point and also at the center, through properly constructed gates which were concreted into the outside walls and the sloping bottoms by angle iron frames. Three parallel railroad tracks ran over the whole length of the bins, two of 1 m. (39.37 in.) gauge from the mines, and one of standard gauge for the transportation of coke.

The extent of this plant required for its construction about 500 t. (550 tons) of fabricated round rods. The time of construction was somewhat more than six months from the time of starting the foundations. In Fig. 334 is shown the reinforcement of the lateral beams, and in Fig. 335 that of the sloping bin bottoms.

The ore pockets in Dudelingen have a capacity of about 5000 cu.m. (176,500 cu.ft). The heavy cross walls which carry the sloping bottoms and the longitudinal walls, are reinforced and constructed as somewhat overhanging.

The beams of the ore crusher floor are stiffened against the heavy vibrations of traffic by special cross-beams. The roof, which is supported by free columns 7.3 m. (24 ft.) high, is arched, and is supplied with tension members. To resist the wind pressure in a longitudinal direction along the roof, diagonal members are supplied.

In this case, also, several expansion joints were installed, to effect which the necessary columns and cross walls were built double.

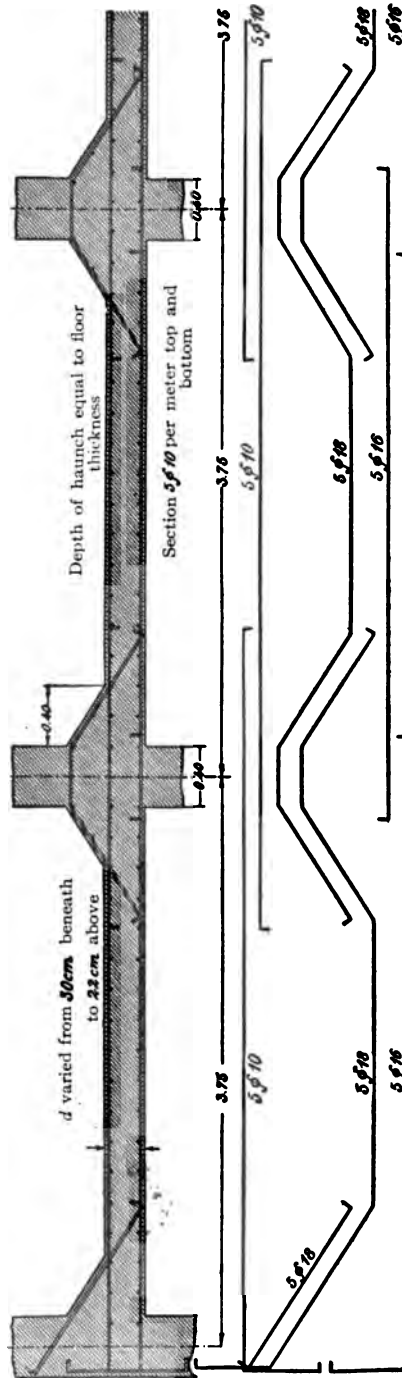

FIG. 335.—Maizière ore pockets. Reinforcement of the sloping bottoms.

Fig. 336 shows a cross and a longitudinal section of the building, and Fig. 337 shows the placing of the reinforcement.

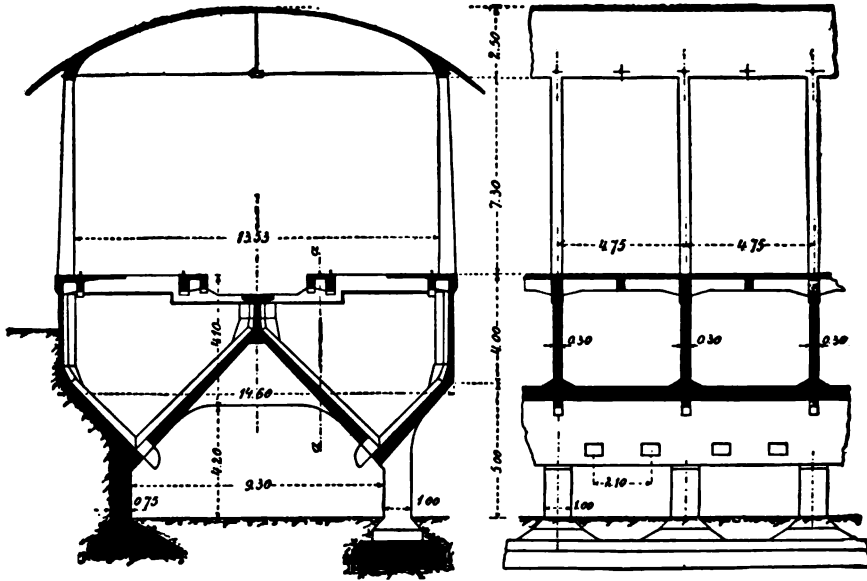

FIG. 336.—Düdelingen ore pockets. Cross and longitudinal sections.

The Getreide silo at Hafen in Genoa is shown in Fig. 338. The building consists in the main of an enlargement of the silos previously built by Hennebique.



FIG. 337.—Düdelingen ore pockets. Placing reinforcement.

Besides a large granary, divided into rooms, a new building was erected 65 m. (203 ft.) long, 40 m. (131 ft.) wide, and 30 m. (98 ft.) high, which contains

126 bins, 3×3 m. (9.8 ft.), and 3×5 m. (9.8×16.4 ft.) in plan. These increased the capacity from about 28,000 t. (30,800 tons) to 50,000 t. (55,000 tons).

The whole building rests on reinforced concrete columns 90×90 cm. (35.4 in.) thick, which have a carrying capacity of 400 t. (440 tons). Under the silos are five loading tracks, the substructure for which, together with the loading platform, are of reinforced concrete. The total load of the silo and tracks was uniformly distributed by means of a continuous reinforced concrete slab upon a twenty-year-old fill of an inlet from the harbor, in such manner that the maximum soil pressure was only 1.7 kg/cm^2 (1.7 tons/ft²).

The construction of the slab with quasi-inverted arches was decided upon because of the necessity of having a flat top surface, so as to secure enough space for the loading tracks and platforms.

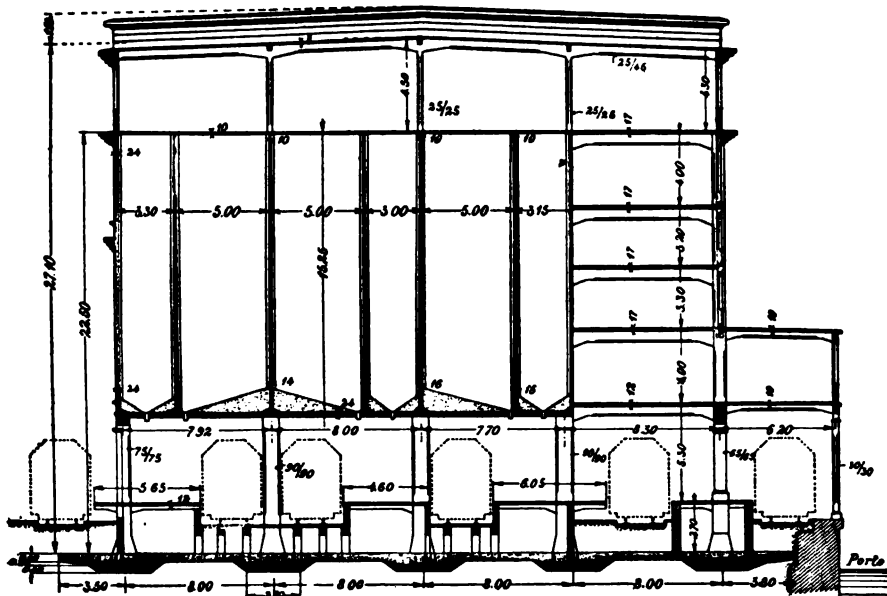

FIG. 338.—Getreide grain isilo, Genoa. Cross-section.

Furthermore, this arrangement enabled the loading tracks to be brought close to the rigidly set automatic scales connected to the mouths of the bottom funnels produced by concreted inclined surfaces on top of the horizontal bin bottoms. The full load of the bottom is hung upon the cross walls, which are correspondingly reinforced so as to form, in combination with the bottom and floor slabs, a continuous beam 15 m. (49.2 ft.) deep, with three spans each 8 m. (26.2 ft.) long.

The construction of the large floor, which was divided into rooms, is clearly shown in the section, while the succeeding illustrations give pictures of the method of erection of the building.

During the period of construction of 200 working days, the following quantities of material were used:

About 900 t. (990 tons) steel almost entirely of German manufacture.

About 2,900,000 kg. (6,393,400 lbs.) cement from the mills of Flli, Palli Caroni Deaglio Casale.

About 11,000 cu.m. (14,380 cu.yds.) sand, gravel and fine slag, largely from the shores of both rivers.

The concrete was mixed by an electric impulse mixer with fixed drum.

In the best months, from August to November, when the daily rate was about 60 cu.m. (78 cu.yds.) of finished concrete, the monthly performance averaged about 200,000 lire (\$38,600).

It is very important, in the design of silos, to know the lateral pressure exerted against the walls by the material in the pockets. In silos of large size, without cross walls, or those with very long rectangular cells, the computation is to be

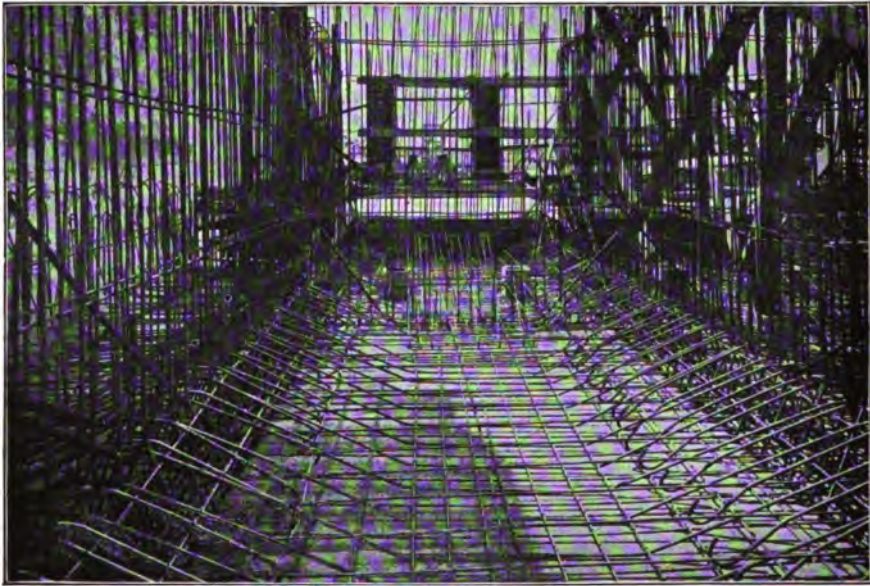

FIG. 339.—Getreide grain silo, Genoa. Reinforcement of the bottoms.

made according to the usual formulas for earth pressure. Neglecting the friction against the walls, the total lateral pressure on the height h is

$$P = \frac{1}{2} \gamma h^2 \tan^2(45^\circ - \phi/2),$$

and the pressure on a differential area at the height h is

$$p = \frac{dP}{dh} = \gamma h \tan^2(45^\circ - \phi/2).$$

For several materials the quantities in Table XXXVII can be employed:

| Material. | kg/m. ³ | γ | lbs/ft. ³ | ϕ | kg/m. ² | lbs/ft. ² |
|----------------------|--------------------|----------|----------------------|--------|--------------------|----------------------|
| Gas coal..... | 800-900 | | 50-56 | 45 | 146 | 30 |
| Cement | 1400 | | 87 | 40 | 305 | 62 |
| Small slag | 1600-1800 | | 100-112 | 45 | 290 | 59 |
| Malt | 530 | | 33 | 22 | 240 | 49 |
| Wheat | 820 | | 51 | 25 | 333 | 68 |
| Minette (ore) . . | 2000 | | 125 | 45 | 343 | 70 |

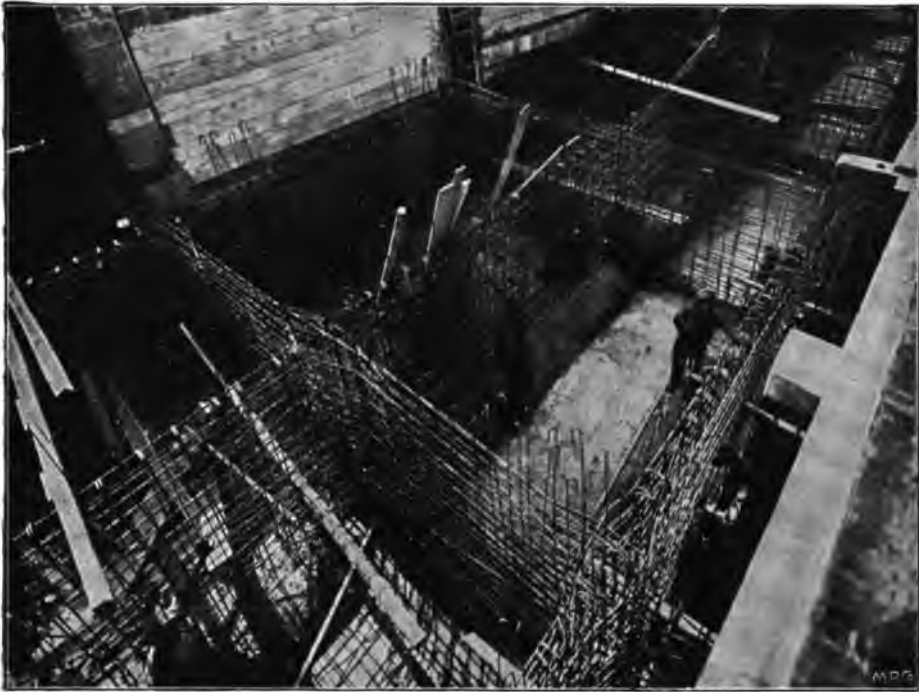

FIG. 340.—Getreide grain silo, Genoa. Reinforcement of the cell walls.



FIG. 341.—View of the silo in Genoa with the colonnade toward the harbor.

In celled silos of considerable height, these figures give very heavy pressures in the lower parts, and the lightening effect of the friction of the material against the walls may be considered. Two publications exist agreeing in all essentials concerning the computation of the lateral pressures in silo cells, by Janssen in "Zeitschrift des Vereins deutscher Ingenieure," 1895, p. 1046, and by Könen in the "Zentralblatt der Bauverwaltung," 1896 p. 446. The friction between the material and the side acts so that the lateral pressures can never exceed a certain fraction of p_{\max} . This fraction may be introduced and the weight of any layer will then become a function, in the computation of the frictional resistance developed.

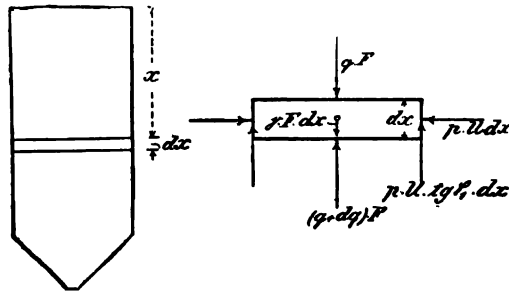

FIG. 342.

In Fig. 342 let it be assumed that in a full cell, at a depth x , a layer of thickness dx is cut out, then the following forces are active.*

- qF , from above, where q is the special pressure in a vertical direction;
- $F\gamma dx$, the weight of the layer;
- $(q+dq)F$, the vertical resistance from below;
- $pU dx$, the horizontal pressure against an area $U dx$;
- $pU \tan \phi_1 dx$, the frictional resistance of the walls at this horizontal pressure and acting upward;

where F is the area of the cell (TRANS.);
and U is the circumference of the cell (TRANS.).

From the equating of the vertical components of the opposite forces, it follows that

$$dq = dx \left(\gamma - p \frac{U}{F} \tan \phi_1 \right).$$

In a material devoid of cohesion under a vertical pressure q , there is developed a lateral pressure.

$$p = q \tan^2(45^\circ - \phi/2),$$

whence

$$dq = dx \left(\gamma - q \tan^2[45^\circ - \phi/2] \frac{U}{F} \tan \phi_1 \right).$$

* See Könen "Zentralblatt der Bauverwaltung," 1896.

If m is inserted in place of the constant factor $\tan^2(45^\circ - \phi/2) \frac{U}{F} \tan \phi_1$ then will

$$dq = dx(\gamma - qm),$$

or

$$d\gamma = \frac{dq}{\gamma - mq},$$

from which, by integration,

$$x = \frac{-1}{m} \log(\gamma - mq) + C.$$

Since q must equal 0, for $x=0$, the value of the constant of integration is

$$C = \frac{1}{m} \log \gamma,$$

so that

$$-mx = \log \frac{\gamma - mq}{\gamma},$$

or

$$\frac{\gamma - mq}{\gamma} = \frac{1}{e^{mx}}.$$

Finally there results

$$q = \frac{\gamma}{m} \left(1 - \frac{1}{e^{mx}} \right),$$

$$p = \frac{\gamma}{m} \left(1 - \frac{1}{e^{mx}} \right) \tan^2(45 - \phi/2).$$

The pressures p and q are thus seen to vary with the depth x , and with increase of the ratio $\frac{U}{F}$, since m then varies. They reach their greatest values for $x=\infty$ and at that point

$$q_{\max} = \frac{\gamma}{m} = \frac{\gamma}{\tan^2(45 - \phi/2) \frac{U}{F} \tan \phi_1},$$

$$p_{\max} = \frac{\gamma}{\frac{U}{F} \tan \phi_1}.$$

The last result can be immediately deduced on the assumption that the maximum pressure exists when the frictional resistance on the wall is equal to the total weight of any layer, or that

$$p_{\max} U dx \tan \phi_1 = F \gamma dx,$$

from which

$$p_{\max} = \frac{\gamma}{\frac{U}{F} \tan \phi_1}.$$

With square section of pocket of side s ,

$$p_{\max} = \frac{\gamma s}{4 \tan \phi_1}.$$

The computation of special values by the formula above given is not readily accomplished, and the following simpler method may be followed: At the top the limiting value of the lateral pressure is to be computed by the formula $p = \gamma h \tan^2 (45^\circ - \phi/2)$, while at a certain depth the value reaches that given by the formula

$$p_{\max} = \frac{\gamma}{\bar{F}} \tan \phi_1,$$

after which it remains constant. It may be assumed then, in accordance with Fig. 343, that the area representing the lateral pressure is bounded by two straight lines. One line starts at the origin of the true curve, and is tangent to it at that point, while the other is the asymptote of the curve.

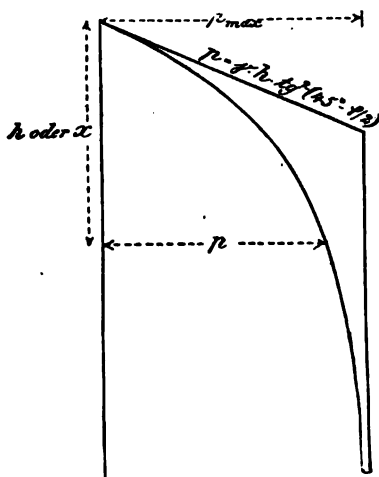

FIG. 343.—Diagram of assumed lateral pressures on silo walls.

with small depth the actual weight will be less than the greatest bottom pressure N , since this value, like p_{\max} ; really exists only at infinitely great depths.

$\tan \phi_1$ represents the coefficient of friction between the contained material and the cell walls, which may be assumed at $\frac{1}{3}$ to $\frac{1}{4}$ for grain, but never greater than $\tan \phi$, or than the coefficient of friction of the material upon itself. Unplastered reinforced concrete walls usually give greater values of $\tan \phi_1$, that is, smaller lateral pressures than wooden walls, and are thus also advantageous in this respect.

When the plan of the pockets deviates from the square form, the bending moments cannot be computed with the formulas $\frac{pl^2}{12}$ and $\frac{pl^2}{24}$. If the form is a

This simple method of computation also gives greater security, which is the more advisable, since experiments have shown that while in motion, materials often exert greater pressures than when at rest.

The greatest bottom pressure can also be computed, so that

$$q_{\max} = \frac{p_{\max}}{\tan^2(45 - \phi/2)}.$$

When still more safety is desired, the weight of the whole cell contents can be assumed as taken by the bottom. Even

rectangle of length l and breadth b , there results, by the law of virtual displacements, or with the formulas of continuity of beams, at the corner (corner moment),

$$M = -\frac{1}{12} \cdot p \cdot \frac{l^3 + b^3}{l + b}.$$

In the center of the side l the moment is

$$M_l = \frac{pl^2}{8} - \frac{1}{12} p \frac{l^3 + b^3}{l + b},$$

while in the center of the side b it is

$$M_b = \frac{pb^2}{8} - \frac{1}{12} p \frac{l^3 + b^3}{l + b}.$$

The formulas are deduced upon the assumption that both walls are of equal strength, and the deformation of the supports provided by the cell walls is negligible.

Experiments concerning the actual wall and bottom pressures in silos have been published by Prante, in the "Zeitschrift des Vereins deutscher Ingenieure," 1896, p. 1122, and by Pleizner, in the same publication in 1906, Nos. 25 and 26. The Pleizner experiments are especially valuable, since they were very extensive and were made on silos of usual dimensions. Various kinds of grains were employed as filling material, and because of the restrained conditions of the cells it was possible to increase the weight of the wheat (per hektoliter) from 790 kg. to 846 kg/m³ (49.3 to 52.8 lbs/ft³). Bottom and side pressures were determined by the exact measurement of deflections produced by wooden shutters after other methods had proved unsatisfactory.

The Pleizner measurements gave a very satisfactory confirmation of the theory developed and the accompanying formulas for p and q . When the corresponding values of the angles of friction ϕ and ϕ_1 , were computed from the measured values of p and q by this formula, the results were obtained with wheat in timber bins of 2.51 to 2.90 m. (8.2 to 9.5 ft.) constant cell section.

TABLE XXXIX

| Depth z . | | Measured Pressure. | | | | Computed Angles. | |
|-------------|------|--------------------|---------------------|-------------------|---------------------|------------------|----------|
| | | p | | q | | | |
| m. | ft. | kg/m ² | lbs/ft ² | kg/m ² | lbs/ft ² | ϕ | ϕ_1 |
| 2.7 | 8.9 | 500 | 102 | 1610 | 330 | 31° 40' | 28° 20' |
| 5.4 | 17.7 | 740 | 151 | 2490 | 510 | 32° 40' | 28° 20' |
| 8.1 | 26.5 | 910 | 186 | 3100 | 635 | 33° 00' | 27° 00' |

The values of ϕ and ϕ_1 thus remain nearly constant, as is assumed in the formula, or in other words: with exactly chosen values of ϕ and ϕ_1 the formulas for p and q give equivalent results. Similar results were also secured with other silos. These apply primarily only to quiescent loading, since the invariably

untrustworthy measurements showed variations in the pressure, when the exit gates were opened. In some cases an increase to one and a half times the static pressure was found. Account of this increase can be secured by introducing smaller angles ϕ and ϕ_1 into the computations. On the other hand, an additional factor of safety for the walls is given, in that the given pressure exists at the centers of the side walls, while it is somewhat less against the corners, although an equal distribution was assumed in the computations. If calculations are made with the values of $\phi=25^\circ$, $\tan \phi_1=0.3$, given on p. 306 for wheat, there are obtained for the large "timber silo," the results of Table XL.

TABLE XL

| Depth. | p | | q | |
|----------|-------------------|-------------------|-------------------|-------------------|
| | Computed. | Observed. | Computed. | Observed. |
| m. | kg/m ² | kg/m ² | kg/m ² | kg/m ² |
| 2.7..... | 720 | 500 | 1770 | 1610 |
| 5.4..... | 1160 | 740 | 2860 | 2490 |
| 8.1..... | 1430 | 915 | 3520 | 3100 |

By the exact formula for p , a security of about $1\frac{1}{2}$ is thus secured, which is sufficiently exact in the light of the increase of the side pressure during emptying of the pocket. This is especially true when the earth pressure formula is used for the upper part and simply p_{\max} for the lower.

FURTHER EXAMPLES OF THE USE OF REINFORCED CONCRETE

Tunnel at Wasserburg a. Inn.—This tunnel pierces a 17 m. (55 ft.) high street embankment, and cuts it at a rather sharp angle. The reinforcement of the tunnel was in the form of an angle and channel lattice work riveted together, that served at the same time as a support for the forms which were temporarily bolted thereto, and as a reinforcement of the tunnel lining in place of the round rods commonly employed. Over the ironwork used for the form support, was driven a 4 cm. (1.6 in.) sheeting, and the tunnel profile was executed from meter to meter, with perpendicular, projecting forms which were stiffened from the starting point.* The metal frame was cross-braced with timber, so as to be able to withstand the heavy and one-sided pressure of the earth. After the concreting and hardening of each ring, the wooden interior forms were shifted.

Shipping Platforms of Reinforced Concrete.—The shipping platform of the Strasburg-Neudorf Railroad, shown in Fig. 345, is constructed on the principle of a retaining wall like an L. The vertical wall spans the space between the ribs, which are anchored in the ground slab. The latter are arched upward, so that they can carry the load of the superimposed earth to the ribs without the

* Poling boards.—(TRANS.)

developing of bending stresses. At distances of about 10 m. (32.8 ft.) expansion joints are provided which cut the entire section.

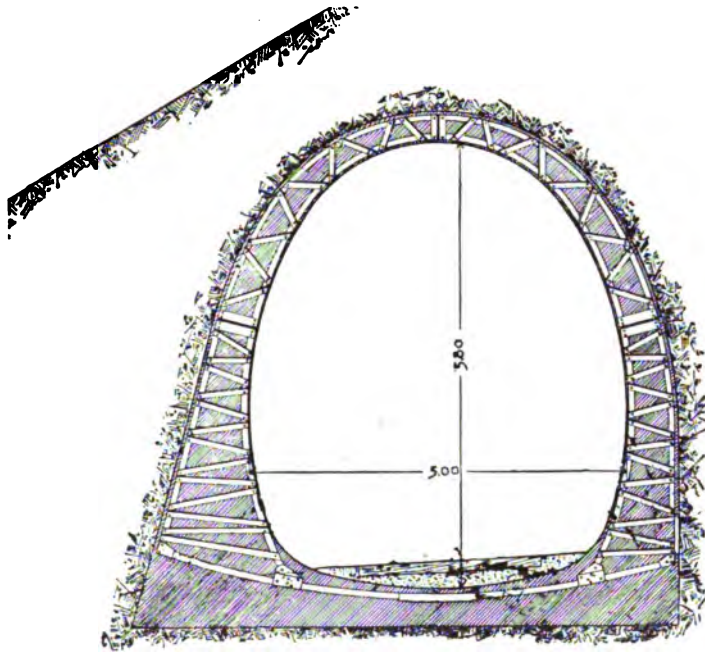

FIG. 344.—Tunnel for the Royal Bavarian City Railroad of Wasserburg a. Inn.

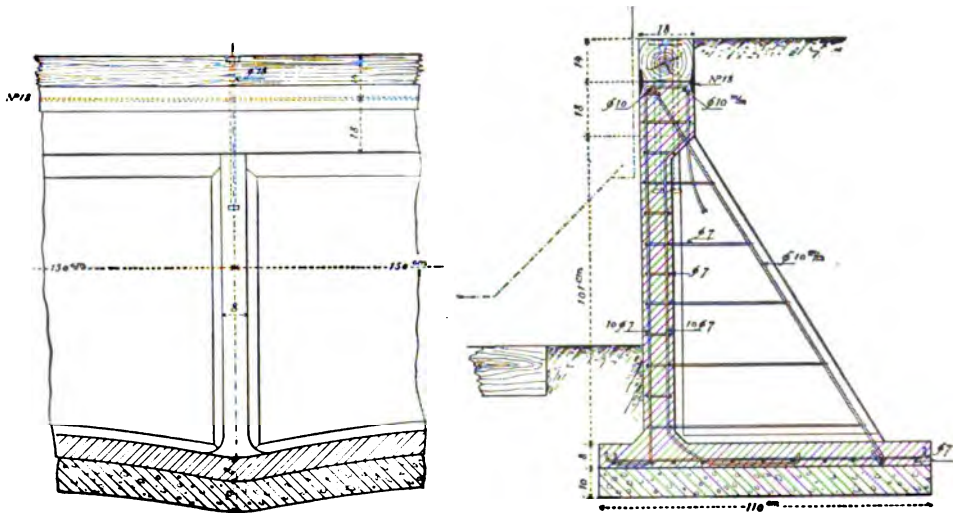

FIG. 345.—Loading platform of the Strassburg-Neudorf Railway Station.

Cooling Towers of Reinforced Concrete.—Reinforced concrete made possible cooling tanks of larger diameter than the usual ones constructed of wood. Aside from the question of durability, they have the advantage that all bracing may be

omitted. The tower, 35 m. (115 ft.) high, erected for the Differdingens Steel Works (Figs. 346 and 347), consisted of a cylindrical substructure of 16 m. (42 ft.) diameter, upon which was a dome, the top of which carried a cylinder 7 m. (23 ft.) in diameter. The construction was designed only for its own weight and wind pressure.

Pipes of Reinforced Concrete are excellent, even for those which must withstand interior pressures. They are reinforced against this pressure by bands



FIG. 346.—Cooling tower of the Differdingen Steel Works.

applied to the cement mortar, which is also reinforced. External forces are also readily resisted by these reinforced concrete pipes, even when thin. Reinforced pipes are especially applicable for turbine penstocks, and have been built for pressures up to 20 m. (66 ft.) head of water. For a whole year some experimental pipes made by Wayss and Freytag were exposed in their Munich storage yard to a pressure of three atmospheres, and even at a computed stress in the wire reinforcement of 1700 to 1800 kg/cm² (24,179 to 25,560 lbs./in²) no cracks appeared, and the pipes were water-tight. The permissible stress in the reinforce-

ment of pipes subjected to internal pressure should not exceed 600 kg/cm^2 (8534 lbs/in^2).

Further mention of applications of reinforced concrete will be omitted without pretention to having covered completely its field. A wide region which it has scarcely as yet entered, is in the building of dykes and dams, in which the new type of construction will provide more secure and more economical structures.

In the calculation of structures in reinforced concrete, the relationship between the external forces and the desired security is not as readily determined as in steel construction. In this connection it is necessary not only to carry through computations with regard to all possible relationships within the project itself, but also to take into consideration the possibility of a loosening of the reinforcement from moisture, and to take this into account in preparing designs. Reinforced concrete constructions which are to be built in accordance with fundamental statical conditions, demand of the designing engineers, that sufficient knowledge and experience are applied to secure the best arrangement in each special case.

Furthermore, the execution of reinforced concrete work requires intimate knowledge and great care, which cannot be secured from every contractor. It is in a certain sense a matter of trust, deserved only by special firms. The worst accidents of the past year also show clearly that the execution of any work should not be separated from its design. Only when both are combined in an undertaking can the right comprehension be secured of the statical relations in the construction, and it will be more necessary, the more the construction deviates from the standard designs of any "system."

It should be striven at all times to place constructions on a scientific basis, and

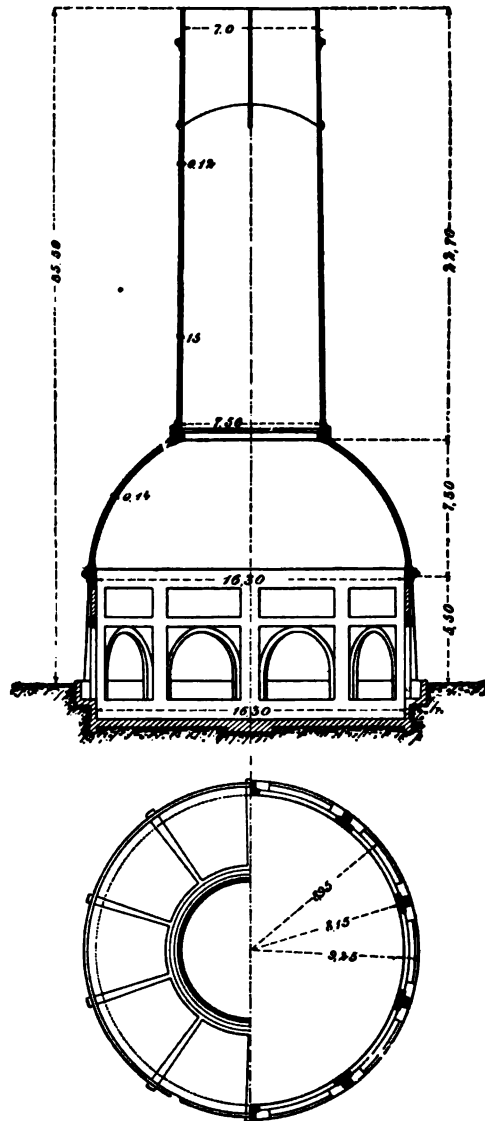

FIG. 347.—Reinforced concrete cooling tower of the Differdingen Steel Works.

not have the ambition to clothe them in a given "system," in the clear knowledge that every such "system" hinders further development. And further, the more or less extensive protection afforded by a patent in various countries is to be considered. The fewer patents of non-essential details that are granted (as is the case in Germany), the quicker will the general and scientific point of view secure attention.

In the next few years, the several scientific commissions investigating reinforced concrete in various countries will provide much additional experimental material, which will shed much light on the yet unsettled questions. In Germany, besides the active "Eisenbeton-kommission der Jubiläumstiftung der Deutscher Industrie," there has of late also been added in this direction the "Deutscher Ausschuss für Eisenbeton in Tätigkeit," which is receiving ample funds for investigation from the government. In its programme, the solution of important questions is provided for. Through the joint work of several testing laboratories it is practically guaranteed that results will not be awaited for any great length of time.

APPENDIX

PRELIMINARY RECOMMENDATIONS (LEITSÄTZE) FOR THE DESIGN, CONSTRUCTION, AND TESTING OF REINFORCED CONCRETE STRUCTURES

(Prepared by the Verband Deutscher Architekten- und Ingenieur Vereine and the Deutscher Beton Verein in the year 1904.)

I. GENERAL

THESE recommendations relate to buildings or structural members composed of concrete with steel reinforcement of any desired variety, in which both elements of construction attain common static efficiency in supporting the load.*

II. BUILDING PRELIMINARIES

As a rule, the form of contract for reinforced concrete structures should include the following points:

1. Plans, showing the design as a whole and in detail.
2. Static computations, giving the contemplated loads and proving comprehensively the adequate safety of the structure.
3. Specifications, concerning the origin, character, and composition of the materials intended for use.
4. Specifications, as to the tensile strength of the reinforcement and of the compressive strength (in cubes) of the concrete.
5. Explanations, of difficult construction features, of the rate of execution, etc.

These contract papers should be signed by their author, and before the commencement of the work by the contractor who is undertaking the erection of the reinforced concrete structure.

Special dispensations granted by local authorities as to methods of construction, in nowise relieve the contractor from full responsibility as to design and execution.

*The Leitsätze thus apply equally to stone construction supplied with reinforcement in such manner that the steel embedded in the mortar resists the tensile or bending stresses.

III. CHECKING PLANS

Since, at the present time, no generally recognized theory exists for the design of reinforced concrete structures, it is recommended that, for the present, all plans for reinforced concrete buildings be checked by the approximate methods contained in the appendix, and there illustrated by examples.

IV. BUILDING CONSTRUCTION

A. SUPERVISION OF WORK AND EMPLOYEES

The contractor for reinforced concrete work must entrust the construction only to such persons as are thoroughly familiar with that method of building.

For the actual work, trained workmen must be employed, under the constant supervision of technical superiors or experienced foremen familiar with this method of construction.

If requested so to do by the builder, or authorized officials, the contractor must produce proof that those entrusted with the direction and supervision of the work are reliable persons who have had previous successful experience in the execution of reinforced concrete work.

B. MATERIALS AND THEIR HANDLING

1. Reinforcement

Before use, the steel is to be cleaned from all dirt and grease, as well as from loose rust.

It is recommended that reinforcing rods subject to tension should be hooked or otherwise so formed as to make more difficult the slipping of the steel in the concrete.

Welding is to be avoided as much as possible, and the weld is never to be located at a dangerous point.

The placing of the reinforcement must be so done that it shall occupy as exactly as possible the positions shown on the plans, and care must be taken that it is completely embedded in the concrete.

The protection of the reinforcing rods, that is, the distance of the surface of the steel from the outside of the concrete, should not be less than 1 cm. (0.4 in.) as a rule. With rods of less diameter than 1 cm., the covering may be reduced to 0.5 cm. (0.2 in.) if a coat of plaster is to be applied later.

2. Cement

Only cement of recognized good quality, equal to standard Portland cement, is to be used.

3. Sand, Gravel, and Other Aggregates

Sand, gravel, and other aggregates must be suitable for making concrete (see II, 4, and V, A 4).

The size of particles of the aggregate must be such as to allow satisfactory working of the concrete between the reinforcing bars and between them and the forms.

Acid * slag may be used as aggregate only when its harmless character has been demonstrated.

4. Concrete

As a rule the concrete must develop after hardening for 28 days under normal climatic conditions, in 30 cm. (11.8 in.) cubes, a compressive strength of from 180 to 200 kg/cm² (2560 to 2845 lbs/in²).

It must be so wet that perfect contact and covering by the mortar of the concrete will be secured with the reinforcement.

The mortar contained in any concrete, wherein is used a sand with grains of varying size up to 7 mm. ($\frac{1}{4}$ in. approx.), must not be leaner than 1:3. Aggregate of gravel or hard broken stone of proper size may be used in quantity up to that of the sand.

The preparation of the concrete must be so conducted that the quantities of the several ingredients are constantly under control. When mixing concrete according to volume (i.e., by measure), it is to be understood that the cement is to be placed in the measure without falling (i.e., being shaken in).

In translating parts by volume into parts by weight, it is to be understood that a cubic meter of Portland cement weighs 1400 kg. (87.4 lbs/ft³).

C. FORMS AND SUPPORTS. TIME OF REMOVAL

The forms must be so strong, and so well fastened and supported that an exact reproduction of the intended structural part will be secured. They must also withstand the tamping of the concrete in thin layers, and must admit of ready removal without danger, allowing necessary supports to remain in place.

The period which must elapse between the final depositing of the concrete and its uncovering (i.e., the removal of forms and supports) depends upon the prevailing weather conditions, the spacing of supports, and the weight of the structural parts in question. The side forms of beams and their supports, as well as the forms for floor slabs of small span, may be removed as soon as the concrete has hardened sufficiently—that is, in a few days—while the supports under the beams should not be removed in less than 14 days. With large spacing between supports, and with structural parts of considerable sectional area, a period of from 4 to 6 weeks should elapse, in some cases.

In buildings of several stories the supports of the lower floors should not be

* As a rule testing with litmus paper will suffice.

removed until the slabs have so hardened that their carrying strength is sufficient to support the superimposed load.

If frost should occur during the period of hardening, the time of removal should be extended at least as long as the period of frost.

D. PROTECTION OF STRUCTURAL PARTS

As soon as completely tamped, all reinforced concrete work must be protected in a suitable manner against injury, and from external influences which might have a detrimental effect upon the attainment of proper carrying power. Care must also be taken that after a structure has attained proper strength, it is not weakened by any proceeding such as the cutting of holes or slots for pipes, etc., at improper points.

V. INSPECTION AND TEST OF WORK.

A. TESTS DURING ERECTION

As a rule, the tests must cover:

1. The adequacy of construction of forms and supports.
2. The accuracy of the use, arrangement, and size of reinforcement according to the drawings.
3. The employment of the proper concrete mixture.
4. The determination that the materials employed possess the strength demanded by the designer. (See II, 4.) This determination can be made either by testing 30 cm. (11.8 in.) cubes in a press at the building site, for the manufacture of which, concrete mixed at the building is to be used, or by securing a certificate of test from a testing laboratory, concerning the strength of portions of the material taken from the building.

Under certain circumstances the test may be conducted by constructing a test member (such as a T-beam), and after a 28-day period of hardening, load it to failure, noting the deflection as exactly as possible.

B. TESTS AFTER COMPLETION

These tests should include:

1. The determination whether the structural members have properly hardened before the forms are removed.
2. The determination whether all structural members, upon being uncovered, are free from defect.
3. The determination whether the calculated strength of the parts of the construction has actually been attained, by cutting (i.e., by making several holes in various floors).
4. Under certain circumstances, the making of load tests. Such tests are always to be undertaken when there is reason to believe the structural parts are

defective in construction, or that they have been injuriously affected as to their supporting power, by some cause.

Load tests should be undertaken only after the concrete has hardened for 45 days.

In making load tests of slabs and beams, if g is the dead weight, and p the uniformly distributed working load, with a whole panel loaded, when the working load is not greater than 1000 kg/m^2 (205 lbs/ft^2), the total test load should not exceed $0.8 g + 1.8 p$.

When the working load is greater than 1000 kg/m^2 (205 lbs/ft^2), the test load is to be proportionately decreased.

Structural members thus loaded may be considered as sufficiently safe when no noticeable permanent deformation takes place.

It is important to determine as accurately as possible the deflection at different stages of the load test.

C. DUTIES OF THE CONTRACTOR

The contractor must be attentive, and when so requested by the builder, or the proper officials, must furnish proof of the correctness of his plans and the excellence of his work, in accordance with sections V, A 4, V, B 3 and V, B 4.

The expense of such plans should bear a proper relation to the total cost of the building.

VI. EXCEPTIONS

Departures from the foregoing recommendations are permissible when they appear to be warranted by exhaustive experiment, by experience gained in the erection of the building, or in the opinion of competent judges.

APPENDIX TO THE FOREGOING RECOMMENDATIONS REGARDING METHODS OF CALCULATION TO BE USED IN TESTING REINFORCED CONCRETE STRUCTURES

I. FUNDAMENTAL ASSUMPTIONS

A. EXTERNAL FORCES

1. Loads

A distinction must be made between

(a) the dead weight of the reinforced concrete, which is to be computed at 2400 kg/m^3 , unless a less weight can be demonstrated.

(b) Other constant loads.

(c) The live or moving load.

2. Reactions, Moments, Shears

(a) For the computation of reactions, moments, and shearing forces, the rules of statics and of the science of elasticity are to be determinative.

(b) To determine the ultimate strength, the most unfavorable distribution or location of the live or moving loads is to be considered.

(c) Possible impact effects may be considered by the customary increase of the moving load.

(d) The distance between points of support is to be computed,

1. In beams, as the center to center distance between supports,

Except when the calculation is governed by other considerations;

2. In freely supported floor slabs, as the free span of the slabs plus the thickness of the slab at its center;

3. In continuous floor slabs, as the distance from center to center of beams.

(e) If conditions at supports produce restraint and continuity of slabs and beams, the bending moments which appear at those points must have reinforcement placed near the upper stressed surface in proportion to the bearing area.

If a continuous beam or slab cannot be so computed, or in regard to the latter, if no restraint is certain at a beam or wall, then, with equal panels and uniformly distributed load, the moment is not to be taken less than $\frac{pl^2}{8}$ over the supports or than $\frac{pl^2}{10}$ at the centers of panels. With unequal panels $\frac{pl^2}{8}$ is to be considered the moment of the largest panel.

Restraint of beams at walls exists in few instances and should therefore be ignored unless special structural arrangements make the restraint certain. In these cases the restraint is to be demonstrated by calculation.

(f) In designing supports the possibility of eccentricity of loading must be considered.

B. INTERNAL FORCES

(a) The internal stresses and strains in the concrete are to be determined upon the assumption of its being a homogeneous material. The modulus of elasticity of concrete in compression E_b will be assumed as constant, so that the ratio of the modulus of elasticity of steel to that of concrete will be $E_c:E_b=n=15$, and accordingly, the steel section is to be employed in computations at 15 times its actual value.

(b) The determination of the internal tensile stresses and strains in the steel is to be made on the assumption that the steel carries the whole tensile stress, the tensile strength of the concrete being ignored.

(c) Steel in compression is to be computed at 15 times its area. The risk of buckling is to be considered.

C. SAFE STRESSES

(a) The permissible stress depends upon the ultimate strength of the material and the method of computation.

(b) Upon the assumption that the concrete when 28 days old has a compressive strength of 180 to 200 kg/cm² (2560 to 2845 lbs/in²), and the steel a tensile strength of 3800 to 4000 kg/cm² (54,041 to 56,893 lbs/in²), the following stresses should not be exceeded when computed by the approximate formulas given later:

| | |
|---------------------------------------|---|
| Concrete in compression from flexure, | 40 kg/cm ² (569 lbs/in ²); |
| “ direct compression, | 35 “ (498 “); |
| “ shear from flexure, | 4.5* “ (64 “); |
| “ adhesion, | 7.5 “ (107 “); |
| Steel in tension, | 1000 “ (14,223 “). |

For concrete of higher compressive strength, correspondingly higher permissible stresses may be allowed, up to 50 kg/cm² (711 lbs/in²). Similar allowance may be made for steel of higher tensile strength.

II. APPROXIMATE METHODS OF COMPUTATION

A. SIMPLE BENDING

1. Rectangular Sections. Slabs.

(a) With single reinforcement. Let

F_e = the section of the reinforcement in square centimeters† found in a breadth b (in centimeters) of the slab.

h = the height above center of reinforcement.

$$n = \frac{E_c}{E_s} = 15;$$

M = moment of the external forces, in centimeter-kilograms.

V = the shearing forces in corresponding sections, in kilograms. Then, according to Fig. 1, the distance of the neutral plane below the top is

$$x = \frac{nF_e}{b} \left[-1 + \sqrt{1 + \frac{2bh}{nF_e}} \right].$$

* Wherever, in T-beams or girders, there exists a shearing stress greater than the permissible one of 4.5 kg/cm² (64 lbs/in²), a part of the lower reinforcing rods may be bent obliquely upward and anchored in the zone of compression in such manner as to resist the diagonal tensile stresses produced at an angle of 45° in the neighborhood of the points of support, and which may be considered equivalent to the shearing stresses. The number of rods thus to be bent is to be determined by the amount of diagonal tensile stress in excess of 4.5 kg/cm² (64 lbs/in²), which they must carry.

It is recommended that in T-beams a rounded or inclined transition be made from the ribs to the floor slabs so as better to transfer the shearing forces from one to the other.

† The formulas are equally serviceable when inches and pounds are substituted.—(TRANS.)

The stress in the concrete is $\sigma_b = \frac{2M}{bx(h-x/3)}$;

the stress in the steel is $\sigma_e = \frac{M}{F_e(h-x/3)}$;

the shearing stress is $\tau_0 = \frac{V}{b(h-x/3)}$;

the adhesive stress on the reinforcement, which must be considered at certain sections, is

$$\tau_1 = \frac{b\tau_0}{\text{Circumference of the reinforcement}}$$

As a rule, the calculation of the shearing and adhesive stresses in slabs is unnecessary.

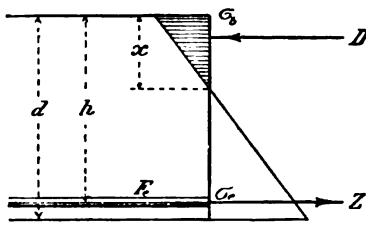

FIG. 1.

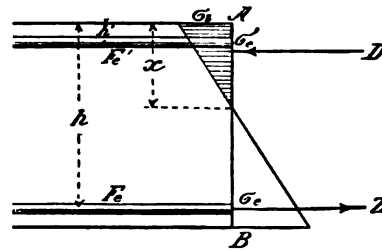

FIG. 2.

(b) With double reinforcement. According to the nomenclature of Fig. 2, the distance x of the neutral plane may be determined by the quadratic equation:

$$x^2 + 2xn \frac{F_e + F_e'}{b} = \frac{2n}{b}(hF_e + h'F_e');$$

x having been ascertained, the compressive stress in the concrete will be

$$\sigma_b = \frac{6Mx}{bx^2(3h-x) + 6F_e'n(x-h')(h-h')};$$

the tensile stress in the lower reinforcement is

$$\sigma_e = \frac{\sigma_b(h-x)n}{x};$$

and the compressive stress in the upper reinforcement is

$$\sigma_e' = \frac{\sigma_b(x-h')n}{x}.$$

2. T-Beams

The effective width of slab b is to be taken as $b \bar{\approx} \frac{1}{3}l$, in which l represents the distance between the supports of the beam, but b must not be greater than the beam spacing.

Two different cases exist:

(a) $x \bar{\approx} d$ (see Fig. 3).

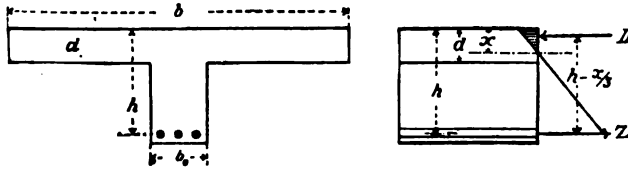

FIG. 3a and 3b.

The formulas given under A, 1 a apply in this case. Under certain circumstances the shear in the rib and the adhesive stress on the reinforcement at the support must be calculated. These are

$$\tau_0 = \frac{V}{b_0(h-x/3)},$$

$$\tau_1 = \frac{b_0 \tau_0}{\text{Circumference of the reinforcement}}$$

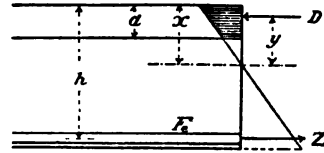

FIG. 4.

(b) $x > d$ (see Fig. 4).

Ignoring the small compressive stress in the rib, there are found

$$x = \frac{2nhF_c + bd^2}{2(nF_c + bd)} \quad \text{and} \quad y = x - \frac{d}{2} + \frac{d^2}{6(2x-d)},$$

$$\sigma_c = \frac{M}{F_c(h-x+y)} \quad \text{and} \quad \sigma_b = \frac{\sigma_c x}{n(h-x)}.$$

B. COMPRESSION

The reinforcement of columns must aggregate at least 0.8% of the total area. The reinforcement subject to stress is to be secured against buckling by lateral ties (usually of round iron). The spacing of these ties should not exceed the diameter of the column.

I. SUPPORTS FOR SAFE LOADS

(a) **Central Loading.**—If F_b represents the area of the concrete member, the permissible load will be

$$P = \sigma_b(F_b + nF_c),$$

where $n=15$. Further,

$$\sigma_b = \frac{P}{F_b + nF_s}; \quad \sigma_e = \frac{P}{F_e + \frac{F_b}{n}} = n\sigma_b.$$

(b) **Eccentric Loading (Bending with Axial Stress).**—The computation can be made in the same manner as for a section of homogeneous material, provided that in all expressions representing the areas of sections and their moments of inertia, the area of reinforcement is to be computed at $n=15$ times its actual value compared with the concrete section. If tension occurs, the reinforcement located on the tension side must be capable of carrying it.

No danger of buckling exists, provided the supports have at least the following dimensions:

| Stress of the Concrete. | | Least Diameter of Round Column in Terms of its Length. | Least Length of Short Side of Rectangular Column in Terms of its Length. |
|-------------------------|----------------------|--|--|
| kg/cm ² | lbs./in ² | | |
| 30 | 427 | 1/18 | 1/21 |
| 35 | 498 | 1/17 | 1/20 |
| 40 | 569 | 1/16 | 1/19 |
| 45 | 640 | 1/15 | 1/18 |
| 50 | 711 | 1/14 | 1/17 |

Since few experiments exist concerning the resistance to buckling, smaller dimensions than those given above should not be used.

III. EXAMPLES OF THE METHOD OF COMPUTATION FOR A FEW SIMPLE CASES

A. SIMPLE BENDING

1. Slabs

(a) Freely Supported Slabs with Single Reinforcement.

| | |
|---------------------------------|---------|
| Clear span | 2.00 m. |
| Thickness of slab | 0.15 " |
| Distance between supports | 2.15 m. |

The live load $p=1000$ kg/m², the dead load $g=0.15 \times 2400=360$ kg., and thus the total load $q=1360$ kg/m², and the moment for 1 m. breadth (see Figs. 1 and 5),

$$M = 1360 \times \frac{2.15^2}{8} \times 100 = 78,583 \text{ cm.-kg.}$$

In a breadth of 1 m. were 9 lower rods of 10 mm. diameter, making $F_e = 7.07$ cm². For $h = 13.5$, $n = 15$, and $b = 100$, the distance x of the neutral axis below the top of the slab is

$$x = \frac{nF_e}{b} \left[-1 + \sqrt{1 + \frac{2bh}{nF_e}} \right] = \frac{15 \times 7.07}{100} \left[-1 + \sqrt{1 + \frac{2 \times 100 \times 13.5}{15 \times 7.07}} \right] = 4.39 \text{ cm.}$$

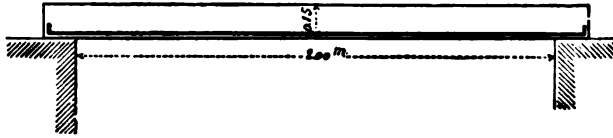

FIG. 5.

Stress in the concrete

$$\sigma_b = \frac{2M}{bx(h-x/3)} = \frac{2 \times 78,583}{100 \times 4.39(13.5 - 4.39/3)} = 29.7 \text{ kg/cm}^2.$$

Stress in the steel

$$\sigma_e = \frac{M}{F_e(h-x/3)} = \frac{78,583}{7.07(13.5 - 4.39/3)} = 923 \text{ kg/cm}^2.$$

The shear at the support is $V = \frac{1}{2} \times 1360 \times 2.0 = 1360$ kg., so that the shearing stress is

$$\tau_0 = \frac{V}{b(h-x/3)} = \frac{1360}{100(13.5 - 4.39/3)} = 1.13 \text{ kg/cm}^2,$$

which is thus less than the permissible value of 4.5 kg/cm².

The adhesive stress of the above reinforcement at the supports is

$$\tau_1 = \frac{b\tau_0}{\text{Circumference of the reinforcement}} = \frac{100 \times 1.13}{9 \times 1.0 \times 3.14} = 4.0 \text{ kg/cm}^2.$$

(b) **Freely Supported Slabs with Double Reinforcement.**—The dimensions and loading of the slab are the same as in the preceding example, so that

$$M = 78,583.$$

Besides the lower reinforcement consisting of 9 rods, 10 mm. diameter, there is an upper layer of 6 rods of 10 mm. diameter. Then

$$F_e' = 4.71, \quad h' = 1.5 \quad (\text{see Fig. 2, p. 324}).$$

The distance x of the neutral layer below the upper surface of the slab is to be computed from the quadratic equation

$$x^2 + 2xn \frac{F_e + F_e'}{b} = 2 \frac{n}{b} (hF_e + h'F_e'),$$

or

$$x^2 + 2 \times x \times 15 \frac{7.07 + 4.71}{100} = 2 \frac{15}{100} (13.5 \times 7.07 + 1.5 \times 4.71).$$

Whence

$$x^2 + 3.534x = 30.75,$$

or

$$x = 4.05 \text{ cm.}$$

Then the compressive stress on the concrete is

$$\begin{aligned} \sigma_b &= \frac{6Mx}{bx^2(3h-x) + 6F_e'n(x-h')(h-h')} \\ &= \frac{6 \times 78,583 \times 4.05}{100 \times 4.05^2(3 \times 13.5 - 4.05) + 6 \times 4.71 \times 15(4.05 - 1.5)(13.5 - 1.5)} = 26.25 \text{ kg/cm}^2. \end{aligned}$$

The tensile stress in the lower reinforcement is

$$\sigma_e = \frac{\sigma_b(h-x)n}{x} = \frac{26.25(13.5 - 4.05)15}{4.05} = 918 \text{ kg/cm}^2,$$

and the compressive stress in the upper reinforcement is

$$\sigma_e' = \frac{\sigma_b(x-h')n}{x} = \frac{26.25(4.05 - 1.5)15}{4.05} = 248 \text{ kg/cm}^2.$$

The distance between the centroids of tension and compression in this case will be

$$\frac{M}{F_e\sigma_e} = \frac{78,583}{7.07 \times 918} = 12.1 \text{ cm.},$$

whence

$$\tau_0 = \frac{V}{100 \times 12.1} = \frac{1360}{100 \times 12.1} = 1.13 \text{ kg/cm}^2,$$

and the adhesive stress on the lower reinforcement at the supports is

$$\tau_1 = \frac{b\tau_0}{\text{Circumference of reinforcement}} = \frac{100 \times 1.13}{9 \times 1.0 \times 3.14} = 4.0 \text{ kg/cm}^2.$$

2. T-Beams

Simple, Freely Supported T-Beams.—Clear span 10.60 m., distance between supports 11.00 m., live load 400 kg/m².

Load per running meter of beam: Live load, 400 × 1.7 = 680 kg.

Asphalt layer, 30 × 1.7 = 51 "

Dead load, 2400(0.25 × 0.50 + 1.7 × 0.10) = 708 "

Uniform total load, approximately, 1440 kg/m².

$$M = g \frac{l^2}{8} = 1440 \times \frac{11^2}{8} \times 100 = 2,178,000 \text{ cm.-kg.}$$

The reinforcement consists of 8 round rods, 28 mm. in diameter with $F_e = 49.26 \text{ cm}^2$. The distance of the neutral axis from the upper layer of the slab (see Fig. 4, p. 325) is to be computed by the formula:

$$x = \frac{2nhF_e + bd^2}{2(nF_e + bd)}$$

so that

$$x = \frac{2 \times 15 \times 54 \times 49.26 + 170 \times 10^2}{2(15 \times 49.26 + 170 \times 10)} = 19.84 \text{ cm.},$$

and

$$y = x - \frac{d}{2} + \frac{d^2}{6(2x - d)} = 19.84 - \frac{10}{2} + \frac{10^2}{6(2 \times 19.84 - 10)},$$

or

$$y = 15.40.$$

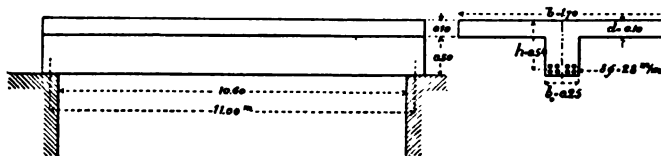

FIG. 6a and 6b.

Then there results finally,

$$\sigma_e = \frac{M}{F_e(h - x + y)} = \frac{2,178,000}{49.26(54.0 - 19.84 + 15.40)} = 892 \text{ kg/cm}^2,$$

$$\sigma_b = \frac{\sigma_e x}{n(h - x)} = \frac{892 \times 19.84}{15(54 - 19.84)} = 34.5 \text{ kg/cm}^2.$$

At the supports the shear is greatest, being

$$V = 1440 \times \frac{10.6}{2} = 7632 \text{ kg.},$$

so that the shearing stress in the concrete is

$$\tau_1 = \frac{V}{b_0(h - x + y)} = \frac{7632}{25(54 - 19.84 + 15.4)} = 6.2 \text{ kg/cm}^2,$$

and the adhesive stress at the supports, on the four round rods of 28 mm. diameter, which extend to them, is

$$\tau_1 = \frac{25 \times 6.2}{4 \times 3.14 \times 2.8} = 4.4 \text{ kg/cm}^2.$$

The shearing stress reaches the maximum permissible value of 4.5 kg/cm² at the point at which

$$V = \frac{7632 \times 4.5}{6.2} = 5540 \text{ kg.},$$

that is, at a point

$$x = \frac{7632 - 5540}{1440} = 1.45 \text{ in. (see Fig. 6 c),}$$

and the total diagonal tension Z_1 , which must be carried by the bent rods will be

$$Z_1 = \frac{145}{\sqrt{2}}(6.2 - 4.5) \times \frac{1}{2} \times 25 = 2180 \text{ kg.}$$

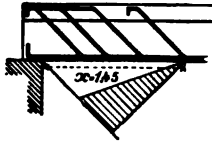

FIG. 6c.

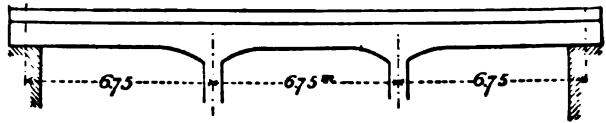

FIG. 7.

When, therefore, the four upper rods of 28 mm. diameter are bent upward through a distance of 1.45 m., they will carry a stress of only

$$\sigma_s = \frac{2180}{4 \times 6.16} = 89 \text{ kg/cm}^2.*$$

3. Continuous T-Beams

Each running meter of the beam (Fig. 7) has to carry a dead load of $g = 2000$ kg., and a live load of $p = 3600$ kg. The following moments therefore result:

(a) At 0.4*l* of the first span:

$$\begin{aligned} M_g &= +0.080 \times 2000 \times 6.75^2 \times 100 = + 728,960 \text{ cm.-kg.} \\ -M_p &= -0.020 \times 3600 \times 6.75^2 \times 100 = - 328,032 \text{ " " " "} \\ +M_p &= +0.100 \times 3600 \times 6.75^2 \times 100 = +1,640,160 \text{ " " " "} \end{aligned}$$

so that

$$M_{\max} = +2,369,120 \text{ " " " "}$$

(b) Over the center supports:

$$\begin{aligned} M_g &= -0.10000 \times 2000 \times 6.75^2 \times 100 = - 911,200 \text{ cm.-kg.} \\ -M_p &= -0.11667 \times 3600 \times 6.75^2 \times 100 = -1,913,575 \text{ " " " "} \\ +M_p &= +0.01667 \times 3600 \times 6.75^2 \times 100 = + 273,415 \text{ " " " "} \end{aligned}$$

so that

$$M_{\max} = -2,824,775 \text{ " " " "}$$

(c) In the center span:

$$\begin{aligned} M_g &= +0.025 \times 2000 \times 6.75^2 \times 100 = + 227,800 \text{ cm.-kg.} \\ -M_p &= -0.050 \times 3600 \times 6.75^2 \times 100 = - 820,080 \text{ " " " "} \\ +M_p &= +0.075 \times 3600 \times 6.75^2 \times 100 = +1,230,120 \text{ " " " "} \end{aligned}$$

so that

$$\begin{cases} +M_{\max} = +1,457,920 \text{ " " " "} \\ -M_{\max} = - 592,280 \text{ " " " "} \end{cases}$$

*The assumption of 4.5 kg/cm² for the shearing stress in connection with the computation of the bent rods is not free from objection. See in this connection, p. 183 and 187.—(THE AUTHOR).

These moments give the following stresses:

(a) At 0.4*l* of the first span:

Since the girders are 4.5 m. apart, the permissible width of slab is

$$b = l/3 = \frac{6.75}{3} = 2.25 \text{ m.}$$

F_e = four round rods of 32 mm. diameter = 32.17 cm².

$h = 77$ cm., $d = 12$ cm., $b = 225$ cm. (see Fig. 8); and the distance x of the neutral axis from the top of the slab computed by the formula

$$x = \frac{2nhF_e + bd^2}{2(nF_e + bd)},$$

is

$$x = \frac{2 \times 15 \times 77 \times 32.17 + 225 \times 12^2}{2(15 \times 32.17 + 225 \times 12)} = 16.8 \text{ cm.}$$

Further

$$y = x - \frac{d}{2} + \frac{d^2}{6(2x - d)},$$

$$y = 16.8 - \frac{12}{2} + \frac{12^2}{6(2 \times 16.8 - 12)} = 11.9 \text{ cm.,}$$

and finally

$$\sigma_e = \frac{M}{F_e(h - x + y)} = \frac{2,369,120}{32.17(77 - 16.8 + 11.9)} = 1020 \text{ kg/cm}^2,$$

$$\sigma_b = \frac{\sigma_e x}{n(h - x)} = \frac{1020 \times 16.8}{15(77 - 16.8)} = 19.0 \text{ kg/cm}^2.$$

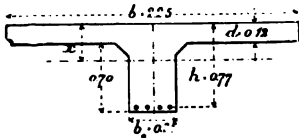

FIG. 8.

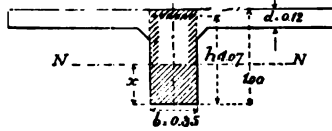

FIG. 9.

The stress in the reinforcement can easily be reduced below 1000 kg/cm², by replacing one 32 mm. rod by one of 34 mm. diameter.

(b) **Over an Intermediate Support.**—Since the tensile strength of the concrete is ignored, the floor slab receives no consideration in connection with the negative pier moment, so that in the computations only a rectangular section (see Fig. 9) of breadth $b = 35$ cm. is employed.

$$F_e = \frac{4 \times 3.2^2 \times \pi}{4} + \frac{2 \times 3.4^2 \times \pi}{4} = 50.33 \text{ cm}^2;$$

$$b = 35 \text{ cm., } h = 107 \text{ cm., } n = 15.$$

$$x = \frac{nF_e}{b} \left[-1 + \sqrt{1 + \frac{2bh}{nF_e}} \right],$$

so that

$$x = \frac{15 \times 50.33}{35} \left[-1 + \sqrt{1 + \frac{2 \times 35 \times 107}{15 \times 50.33}} \right];$$

$$x = 49.5 \text{ cm.}$$

Further

$$\sigma_b = \frac{2M}{bx(h-x/3)} = \frac{2 \times 2,824,775}{35 \times 49.5 \left(107 - \frac{49.5}{3} \right)} = 36 \text{ kg/cm}^2,$$

$$\sigma_e = \frac{M}{F_e(h-x/3)} = \frac{2,824,775}{50.33 \left(107 - \frac{49.5}{3} \right)} = 621 \text{ kg/cm}^2.$$

(c) At the middle of the center span:

$$+M_{\max} = +1,457,920 \text{ cm.-kg.}$$

$$F_e = \frac{3 \times 3.2^2 \times \pi}{4} = 24.13 \text{ cm}^2, \quad b = 225 \text{ cm.}, \quad h = 77 \text{ cm.}, \quad d = 12 \text{ cm.},$$

so that, as under (a),

$$x = \frac{2 \times 15 \times 24.13 \times 77 + 225 \times 12^2}{2(15 \times 24.13 + 225 \times 12)} = 14.4 \text{ cm.},$$

$$y = 14.4 - \frac{12}{2} + \frac{12^2}{6(2 \times 14.4 - 12)} = 9.8 \text{ cm.}$$

$$\sigma_e = \frac{M}{F_e(h-x+y)} = \frac{1,457,920}{24.13(77 - 14.4 + 9.8)} = 833 \text{ kg/cm}^2;$$

$$\sigma_b = \frac{\sigma_e x}{n(h-x)} = \frac{833 \times 14.4}{15(77 - 14.4)} = 12.8 \text{ kg/cm}^2.$$

$$-M_{\max} = -592,280 \text{ cm.-kg.}$$

$$h = 77 \text{ cm.}, \quad F_e = \frac{1 \times 3.4^2 \times \pi}{4} = 9.08 \text{ cm}^2, \quad b = 35 \text{ cm.}$$

$$x = \frac{nF_e}{b} \left[-1 + \sqrt{1 + \frac{2bh}{nF_e}} \right],$$

or

$$x = \frac{15 \times 9.08}{35} \left[-1 + \sqrt{1 + \frac{2 \times 35 \times 77}{15 \times 9.08}} \right],$$

$$x = 20.9 \text{ cm.};$$

$$\sigma_b = \frac{2M}{bx(h-x/3)} = \frac{2 \times 592,280}{35 \times 20.9 \left(77 - \frac{20.9}{3} \right)} = 23.2 \text{ kg/cm}^2$$

$$\sigma_e = \frac{M}{F_e(h-x/3)} = \frac{592,280}{9.08 \left(77 - \frac{20.9}{3} \right)} = 932 \text{ kg/cm}^2.$$

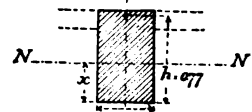

FIG. 10.

The computation of the shearing stresses follows, as in example 2.

B. COMPRESSION, COLUMNS

The intermediate supports of example 3 (ignoring the continuity) have to carry a load of

$$P = 6.75(2000 + 3600) = 37,800 \text{ kg.}$$

The section is 35×35 cm., and 4 round rods of 24 mm. diameter, with $F_e = 18.1$ cm², are employed. Then

$$F_b = 1225 \text{ cm}^2.$$

$$F_e = 18.1 \text{ cm}^2.$$

$$\sigma_b = \frac{P}{F_b + nF_e} = \frac{37,800}{1225 + 15 \times 18.10} = 25.3 \text{ kg/cm}^2,$$

$$\sigma_e = n\sigma_b = 25.3 \times 15 = 380 \text{ kg/cm}^2.$$

REGULATIONS OF THE ROYAL PRUSSIAN MINISTRY OF
PUBLIC WORKS, FOR THE CONSTRUCTION OF REIN-
FORCED CONCRETE BUILDINGS. MAY 24, 1907

I. GENERAL

A. TESTING

Sec. 1

1. The construction of buildings or their structural parts in reinforced concrete is to be subject to special supervision by the building inspectors. For this reason, when application is made for a permit for a structure in whole or in part of reinforced concrete, drawings, statical calculations and specifications must be submitted in which the general plans and all important details are shown.

In case the owner or contractor does not decide upon the use of reinforced concrete until the work is under way, the building inspectors must insist that the above described drawings for the reinforced concrete work be filed a sufficient period before commencing the construction. Under no circumstances is work to be begun before permission therefor has been granted.

2. The specifications must state the source and the kind of concrete aggregates to be used, their proportions, the amount of water, and the compressive strength which is to be developed by 30 cm. (11.8 in.) cubes, 28 days old, made at the building site, and of the materials stated. If required by the building inspectors, the compressive strength must be shown by test before commencing work.

3. The concrete must be mixed in proportions by weight; a bag of 57 kg. (125.4 lbs.), or a barrel of 170 kg. (374 lbs.) of cement being the unit of measure.

The aggregates may be either weighed, or measured in vessels the capacity of which has previously been so arranged that the weight corresponds with the proportions already determined.

4. The contract is to be signed by the owner, and by the general contractor and the special contractor who is to do the work. The building inspectors are to be notified of any change of contractors.

Sec. 2

1. The quality of the concrete materials is to be certified by an official testing laboratory. As a rule, such certificates must not be more than a year old.

2. Only such Portland cement may be used as fulfils the Prussian requirements. The certificates of its quality must give particulars as to its constancy of volume, time of set, fineness, as well as of its tensile and compressive strength. The constancy of volume and time of set must be independently tested by the builder.

3. Sand, gravel and other aggregates must be proper for the manufacture of concrete, and the special purpose intended. The size of the particles must be such that the placing of the concrete, and its tamping between the reinforcing rods and between them and the forms can be done with certainty and without displacing the steel.

Sec. 3

1. The method of computation must provide at least as much security as that provided according to the "Leitsätze," section II, and according to the methods of calculation with examples in section III of these Regulations. This must be demonstrated by the contractor, if required.

2. In the case of new types of construction, the building inspectors may condition the permit on the results of preliminary test structures and loading experiments. The latter are to be carried to the point of failure.

B. CONSTRUCTION

Sec. 4

1. The building inspectors may have the quality of the materials in use in the work tested by an official laboratory, or in any other manner deemed suitable by them, and can also have tested the strength of the concrete made therefrom. The strength tests can also be made at the building site by a concrete press, the accuracy of which has been certified by an official testing laboratory.

2. The specimens to be so tested must be cubes, 30 cm. (11.8 in.) on an edge. These specimens are to be dated, sealed for identification, and stored until they have properly hardened, in accordance with the instructions of the building officials.

3. The cement must be delivered in the original package at the point of consumption.

4. The concrete must be mixed in such manner that the quantities of the several constituents always agree with the specified proportions, and can always be readily determined. Where measuring vessels are employed, they are always to be filled in the same manner and to the some degree of compactness.

Sec. 5

1. As a rule the manipulation of the concrete must commence immediately after it is mixed, and must be completed before it has begun to set.

2. In warm, dry weather, the concrete must not lie unused longer than one hour, and in cooler damp weather, longer than two hours. Concrete that is not immediately placed, must be protected from climatic influences, such as sun, wind and heavy rain, and must be re-mixed before use.

3. The manipulation of the concrete must always be continuous until the tamping is complete.

4. The concrete must be laid in layers not more than 15 cm. (6 in. approx.) thick, and should be tamped as much as the amount of water present will permit. Rammers of suitable form and weight are to be used for the tamping.

Sec. 6

1. Before placing, the reinforcement is to be cleaned of all loose rust, dirt and grease. Special care is to be exercised to see that the reinforcement is in proper position, that the rods are of correct form and are properly spaced and kept in place by necessary contrivances, and are completely enveloped in special fine concrete. Where the reinforcement in the beams is in several layers, each one must be separately embedded. Beneath the reinforcement must be a layer of concrete at least 2 cm. ($\frac{3}{4}$ in. approx.) thick in beams, and at least 1 cm. ($\frac{3}{8}$ in. approx.) thick for slabs.

2. The forms and supports of the floors and beams must be strong enough to resist bending, and be solid enough to withstand the tamping. The forms are to be so devised that they can be removed without disturbing such supports as may be necessary until the concrete has properly set. As far as possible, only unspliced lumber is to be used for supports. If splices are unavoidable, the supports must be strongly and firmly connected at the joints.

3. Column forms must be so constructed that the depositing and compacting of the concrete can be done through one open side, which is closed as the work progresses, so that it may be closely inspected.

4. At least three days' notice must be given the building inspectors before the completion of the forms and the proposed commencement of the concreting for each story.

Sec. 7

1. As far as possible, the several concrete layers must be deposited on fresh material; but in every case, the top of the old layer must be roughened.

2. When work is to be done on hardened concrete, the old top surface must first be roughened, swept clean, wetted, and coated with a thin cement grout before new material is deposited.

Sec. 8

In the construction of walls and columns in buildings several stories in height, work on the upper members can be continued only after the structural parts in the lower stories have become sufficiently hard.

Sec. 9

1. During freezing weather, work can be carried on only under such conditions as will preclude the possibility of injury by the frost. Frozen materials must not be used.

2. On the advent of mild weather, after a prolonged freeze (Sec. 11), work can be continued only after permission so to do has been obtained from the building inspectors.

Sec. 10

1. Until the concrete has properly hardened, the structural parts must be protected against the effects of frost and against premature drying out, as well as against vibration and loading.

2. The interval which must elapse between the completion of the tamping, and the removal of the forms and supports must depend upon the prevailing weather, the spacing of supports and the weight of the members. The side forms of beams, column forms, and floor slab forms must not be removed in less than eight days, and the supports of the beams in not less than three weeks. With large spacings of columns and areas of members, the interval must be extended to six weeks.

3. In many-storied buildings, the supports under the lower slabs and beams can be removed only when the hardening of the upper ones has so far advanced that they can support themselves.

4. When the tamping was completed but a short time before frost occurred, the removal of forms and supports is to be done with the greatest care.

5. Should freezing take place during the period of hardening, in view of the fact that the latter may have been retarded by the frost, the intervals mentioned in section 2 should be extended by at least the frozen period.

6. For the removal of forms and supports, special contrivances (wedges, sand boxes, etc.) must be employed to prevent shock.

7. The building inspectors must be given at least three days' notice of the removal of forms and supports.

Sec. 11

A diary must be kept of the progress of the work, and it must always be open for inspection at the building site. Freezing weather is to be specially noted therein, together with the temperatures and the hour of their observation.

C. REMOVAL OF FORMS

Sec. 12

1. The structural parts must be exposed at different points as required by the building inspectors, so that the character of the work may be determined. The right is reserved to determine by tests the hardness and strength of questionable parts.

2. Should question arise as to the proportions and degree of hardness of any portion, test samples may be taken from the finished parts.

3. Where load tests are considered necessary, they are to be conducted according to the directions of the proper officials. The owner and the contractor will be given due notice, and those interested informed. Loading tests should be made not less than 45 days after the concrete has set, and be restricted to the portion deemed necessary by the building inspectors.

4. In load tests of slabs and beams, the following method is to be adopted: In loading a whole floor panel, if g is the dead load, and p the uniformly distributed live load, the applied load is not to exceed $0.5g + 1.5p$. With live loads of more than 1000 kg/m^2 (205 lbs/ft^2), simply the live load may be used. If only a strip of the floor is to be tested, the load is to be uniformly distributed over a space at the center of the slab, the length of which is equal to the span, and a third of the span in breadth, but never less than 1 meter (3.3 ft.). The applied load in this case is not to exceed a value of $g + 2p$. The dead load is that of all the structural parts, including the weight of the flooring and slab, the live load being of the character specified in Sec. 16, No. 3.

5. In any loading tests of columns, unequal settlement of the structural parts and an overloading of the subsoil is to be avoided.

II. RECOMMENDATIONS FOR STATICAL COMPUTATIONS

A. DEAD LOAD

Sec. 13

1. The weight of the concrete, including the reinforcement is to be assumed at 2400 kg/m^3 (149 lbs/ft^3), unless otherwise specifically stated.

2. With that of the slab is also to be included the weight of the material forming the finish, determined according to known units.

B. DETERMINATION OF EXTERNAL FORCES

Sec. 14

1. In members subjected to flexure, the applied moments and reactions are to be computed according to the usual rules for the kind of loading and manner of support of freely supported or continuous beams.

2. In freely supported slabs, the clear span, plus the thickness of the slab at the center, is to be considered as the length in computations, and in continuous slabs the distance between centers of supports is to be employed. In beams, the length is to be considered as the free span increased by the width of the supports.

3. In slabs and beams, continuous over several spans, where the moments and reactions cannot be computed according to the rules for continuous members, under the assumptions of free supports at ends and intermediate points, or cannot be determined by experiment, the bending moments at the centers of spans are to be taken as four-fifths of the value for a slab resting freely on two supports. Over the supports, the negative moments are to be the same as the span moments when both sides are freely supported. Beams and slabs are to be computed as continuous according to these rules only when the supports are rigid and at the same level, or consist of reinforced concrete beams. In arranging the reinforcement, under all circumstances the possibility of the occurrence of negative moments is to be considered.

4. In beams, moments from end restraint are to be included in computations only when special structural conditions make true restraint possible.

5. Continuity is not to be assumed over more than three spans. With live loads of more than 1000 kg/m² (205 lbs/ft²) the calculations are to be made for the most unfavorable arrangement of load.

6. In computations of T-beams, the width of each flange at the center of span is not to be assumed as more than one-sixth the length of the beam.

7. Rectangular slabs, freely supported on all sides, with double reinforcement and uniformly distributed load can be computed according to the formula, $M = \frac{pb^2}{12}$, when the long side a is less than one and a half times the breadth b . Special forms and distribution of reinforcing rods are to be employed to care for negative moments at supports.

8. Even when so computed, thickness of slabs and of the flanges of T-beams is never to be less than 8 cm. (3.1 in.).

9. In columns, the possibility of eccentric loading is to be considered.

C. DETERMINATION OF INTERNAL FORCES

Sec. 15

1. The modulus of elasticity of the reinforcement is to be assumed as fifteen times that of the concrete, unless otherwise specified.

2. The stresses in any section of a body under flexure are to be computed on the assumption that the strains are proportional to the distances from the neutral axis, and that the reinforcement carries all the tension.

3. In buildings or members exposed to the weather, to dampness, to smoke gases, and similar deleterious influences, it must be shown that cracks will not occur from the tensile stress to which the concrete is subjected.

4. Shearing stresses are to be considered, unless the form and arrangement of the members show their harmless nature. They must be carried by a proper

arrangement of the reinforcement, whenever the design of the structure is not made to care for them.

5. As far as possible, the reinforcement must be so constructed as to preclude its displacement in the concrete. Adhesive stresses should always be susceptible of mathematical determination.

6. Columns should always be computed with regard to buckling unless the length is less than eighteen times the least lateral dimension. The spacing of the longitudinal reinforcement is to be maintained by cross ties. The spacing of the ties must not exceed the least dimension of the column or be more than thirty times the diameter of the reinforcing rods.

7. In computing columns with regard to buckling, the Euler formula is to be employed.

D. PERMISSIBLE STRESSES

Sec. 16

1. In members subjected to flexure, the compressive stress of the concrete should be one-sixth of its ultimate value, and the compressive and tensile stresses in the reinforcement should not exceed 1000 kg/cm^2 ($14,223 \text{ lbs/in}^2$).

2. If the tensile stress in the concrete must be considered as required in Sec. 15, No. 3, two-thirds of the tensile strength of the concrete as determined by experiment, may be allowed. When tension tests are wanting, the tensile stress is not to be assumed greater than one-tenth the ultimate compressive strength.

3. The following loading values are to be assumed:

(a) In members subject to moderate vibration, as in the floors of dwellings, stores, warehouses,—the actual dead and live loads.

(b) In members subject to more violent vibration or to widely fluctuating loads, as in the floors of places of assembly, dance halls, factories, storehouses—the dead load—plus the live load increased 50%.

(c) In loads attended by violent impact, as in the roofs of cellars under driveways and courtyards—the dead load plus the live load increased 100%.

4. In columns, the concrete should not be stressed to more than one-tenth its ultimate strength. In computing the reinforcement with regard to buckling, a factor of safety of five is to be employed.

5. The shearing stress in the concrete is not to exceed 4.5 kg/cm^2 (64 lbs/in^2). If a greater shearing strength is possible, the permissible stress is not to be more than one-fifth of the ultimate strength.

6. The adhesive stress is not to exceed the permissible shearing stress.

III. METHODS OF CALCULATION, WITH EXAMPLES

A. SIMPLE BENDING

(a) Without reference to the tensile stress in the concrete.

With single reinforcement of total area f_s of a beam or slab of width b , if the ratio of the moduli of elasticity of the steel and the concrete is represented by n , then the distance of the neutral axis below the top is given by the equation of the statical moments of the elemental areas about this axis (see Fig. 1).

$$\frac{bx^2}{2} = n f_s (h - a - x) \dots \dots \dots (1)$$

is

$$x = \frac{n f_s}{b} \left[\sqrt{1 + \frac{2b(h-a)}{n f_s}} - 1 \right] \dots \dots \dots (2)$$

From the equality of the moments of the external and internal forces, it will follow that

$$M = \sigma_b \frac{x}{2} b \left(h - a - \frac{x}{3} \right) = \sigma_s f_s \left(h - a - \frac{x}{3} \right), \dots \dots \dots (3)$$

wherein σ_b indicates the maximum concrete compressive stress, and σ_s the average steel tension. From this there follows

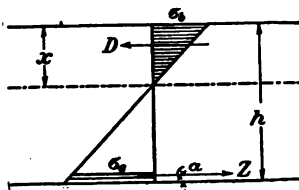

FIG. 1.

$$\sigma_b = \frac{2M}{bx \left(h - a - \frac{x}{3} \right)}; \dots \dots \dots (4)$$

$$\sigma_s = \frac{M}{f_s \left(h - a - \frac{x}{3} \right)} \dots \dots \dots (5)$$

Under certain circumstances the following easily obtained equations are of value

$$x = \frac{n(h-a)\sigma_s}{\sigma_s + n\sigma_b}, \dots \dots \dots (6)$$

$$\sigma_b \frac{bx}{2} = \sigma_s f_s \dots \dots \dots (7)$$

In T-shaped sections, such as T-beams, the calculation does not differ from that above when the neutral axis falls within the slab or at its lower edge.

If the neutral axis is in the stem, the small compression in the stem may be ignored.

Then (see Fig. 2)

$$\sigma_u = \frac{x-d}{x} \sigma_o^* \dots \dots \dots (8)$$

$$\sigma_e = n \frac{h-a-x}{x} \sigma_o; \dots \dots \dots (9)$$

$$\frac{\sigma_o + \sigma_u}{2} bd = \sigma_e f_e, \dots \dots \dots (10)$$

or, by introducing into equation (10) the values of σ_u and σ_e from equations (8) and (9)

$$x = \frac{\frac{bd^2}{2} + nf_e(h-a)}{bd + nf_e} \dots \dots \dots (11)$$

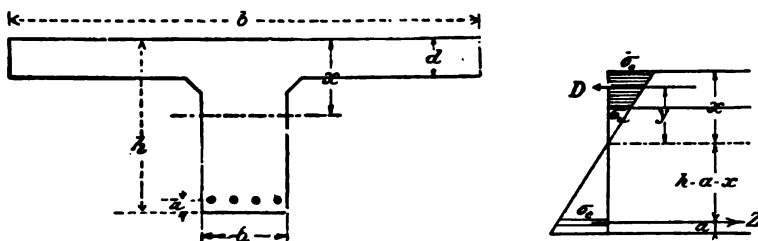

FIG. 2.

Since the distance of the centroid of the compression trapezoid below the top is

$$x - y = \frac{d \sigma_o + 2\sigma_u}{3 \sigma_o + \sigma_u} \dots \dots \dots (12)$$

there is obtained by introducing the value of σ_u from equation (8)

$$y = x - \frac{d}{2} + \frac{d^2}{6(2x-d)} = \frac{2}{3} \left(x + \frac{(x-d)^2}{2x-d} \right); \dots \dots \dots (13)$$

$$\sigma_e = \frac{M}{f_e(h-a-x+y)}; \dots \dots \dots (14)$$

$$\sigma_o = \frac{x\sigma_e}{n(h-a-x)} \dots \dots \dots (15)$$

When beams and slabs also contain top reinforcement, the following equations may be employed:

For the location of the neutral axis:

$$\frac{bx^2}{2} - f_e'(x-a) + nf_e'(x-a) = nf_e(h-a-x), \dots \dots \dots (16)$$

from which

$$x = -\frac{(n-1)f_e' + nf_e}{b} + \sqrt{\left(\frac{(n-1)f_e' + nf_e}{b} \right)^2 + \frac{2}{b} [(n-1)f_e'a + nf_e(h-a)]}. \dots (17)$$

* σ_u = concrete stress at under side of slab.—TRANS.
 σ_o = concrete stress at top of slab.—TRANS.

For the applied moment

$$M = \frac{bx}{2}\sigma_b\left(h-a-\frac{x}{3}\right) - f_e'\sigma_b'(h-2a) + f_e'\sigma_e'(h-2a). \quad \dots (18)$$

Here σ_b' represents the concrete compressive stress at the average height of the top reinforcement, and is determined by

$$\sigma_b' = \frac{x-a}{x}\sigma_b.$$

Since, further,

$$\sigma_e' = \frac{n(x-a)}{x}\sigma_b,$$

it will follow that

$$M = \left[\frac{bx}{2}\left(h-a-\frac{x}{3}\right) + (n-1)f_e'\frac{x-a}{x}(h-2a) \right] \sigma_b. \quad \dots (19)$$

If the slight reduction in the area of the compressed concrete made by the reinforcement is ignored, equation (17) becomes

$$x = -\frac{n(f_e+f_e')}{b} + \sqrt{\left(\frac{n(f_e+f_e')}{b}\right)^2 + \frac{2n}{b}(f_e'a+f_e(h-a))}, \quad \dots (20)$$

and (19) becomes

$$M = \left[\frac{bx}{2}\left(h-a-\frac{x}{3}\right) + nf_e'\frac{x-a}{x}(h-2a) \right] \sigma_b. \quad \dots (21)$$

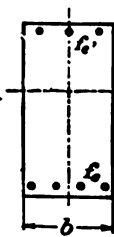

FIG. 3.

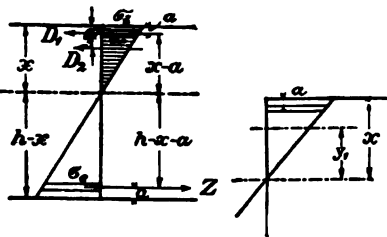

FIG. 4.

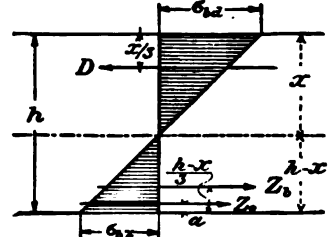

FIG. 5.

If σ_b has been computed by equation (21) for a given moment the stresses σ_e and σ_e' are easily determined from the law that the stress is proportioned to the distance from the neutral axis. If the maximum moment has been determined for a permissible concrete compressive stress σ_b , the stresses σ_e and σ_e' are to be found from

$$M = f_e\sigma_e\left(h-a-\frac{x}{3}\right) \pm f_e'\sigma_e'\left(\frac{x}{3}-a\right), \quad \dots (22)$$

or since

$$\sigma_e' = \frac{x-a}{h-a-x}\sigma_e.$$

$$M = \left[f_e\left(h-a-\frac{x}{3}\right) \pm f_e'\frac{x-a}{h-a-x}\left(\frac{x}{3}-a\right) \right] \sigma_e. \quad \dots (23)$$

The common centroid of the concrete and the reinforcement in the zone of compression may be determined from

$$y_1 = \frac{\frac{bx^2}{2} \sigma_b + \sigma_e' f_e' (x-a)}{\frac{bx}{2} \sigma_b + \sigma_e' f_e'} = \frac{\frac{bx^3}{3} + n f_e' (x-a)^2}{\frac{bx^2}{3} + n f_e' (x-a)} \dots (24)$$

and then

$$M = f_e \sigma_e (h-a-x+y_1) \dots (25)$$

b. Taking into consideration the concrete tensile stresses.

With single reinforcement, the equation corresponding to equation (1), (see Fig. 5), is

$$\frac{bx^2}{2} = \frac{b(h-x)^2}{2} + n f_e (h-a-x), \dots (26)$$

so that

$$x = \frac{\frac{bh^2}{2} + n f_e (h-a)}{bh + n f_e} \dots (27)$$

From the equality of the tensile and compressive forces, there follows

$$\frac{bx}{2} \sigma_{bd} = b \frac{h-x}{2} \sigma_{bz} + \sigma_e f_e, \dots (28)$$

and from the proportionality of stress and strain

$$\sigma_{bz} = \frac{h-x}{x} \sigma_{bd}, \dots (29)$$

$$\sigma_e = n \frac{h-a-x}{x} \sigma_{bd} \dots (29a)$$

The moment equation for the neutral axis is

$$M = \frac{bx}{2} \sigma_{bd} \frac{2}{3} x + b \frac{h-x}{2} \sigma_{bz} \frac{2}{3} (h-x) + \sigma_e f_e (h-a-x), \dots (30)$$

from which there follows, with the help of equations (29) and (29a),

$$M = \frac{\sigma_{bd}}{x} \left[\frac{bx^3}{3} + \frac{b(h-x)^3}{3} + n f_e (h-a-x)^2 \right] \dots (31)$$

When M is given, σ_{bd} can be determined from equation (31), and then with equations (29) and (29a), σ_{bz} and σ_e .

In T-beams, when the neutral axis passes through the stem:

$$x = \frac{\frac{h^2}{2} + (b-b_1) \frac{d^2}{2} + n f_e (h-a)}{b_1 h + (b-b_1) d + n f_e}; \dots (32)$$

$$M = b \frac{\sigma_o + \sigma_u}{2} d y + b_1 \frac{\sigma_u}{2} \frac{2}{3} (x-d)^2 + b_1 \frac{h-x}{2} \sigma_{bz} \frac{2}{3} (h-x) + \sigma_e f_e (h-a-x), \dots (33)$$

$$M = \frac{\sigma_0}{x} \left[\frac{b}{2} d(2x-d)y + \frac{b_1}{3} ((x-d)^3 + (h-x)^3) + n f_c (h-a-x)^2 \right]; \quad (33a)$$

$$\sigma_{bs} = \frac{h-x}{x} \sigma_0; \quad (34)$$

$$\sigma_e = n \frac{h-a-x}{x} \sigma_0. \quad (34a)$$

These equations are very inconvenient for the determination of the dimensions of sections for a given applied moment. If b, b_1, h and f_c are given, and the assumption is made that the neutral axis coincides with the lower edge of the slab, then

$$\frac{bx^2}{2} = b_1 \frac{(h-x)^2}{2} + n f_c (h-a-x), \quad (35)$$

whence

$$\frac{b-b_1}{2} x^2 + (b_1 h + n f_c) x = \frac{b_1 h^2}{2} + n f_c (h-a). \quad (36)$$

From this x is found and the thickness of slab. The stresses which occur are found from

$$M = \frac{\sigma_0}{x} \left[\frac{bx^3}{3} + b_1 \frac{(h-x)^3}{3} + n f_c (h-a-x)^2 \right], \quad (37)$$

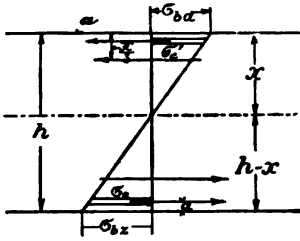

FIG. 6.

and from equations (34) and (34a).

When reinforcement is introduced also into the zone of compression, there are found for both beams and slabs (see Fig. 6)

$$x = \frac{\frac{bh^2}{2} + (n-1)[f_c' a + f_c (h-a)]}{bh + (n-1)(f_c' + f_c)}, \quad (38)$$

$$M = \left[\frac{bx^3}{3} + \frac{b(h-x)^3}{3} + (n-1)(f_c' (x-a)^2 + f_c (h-a-x)^2) \right] \frac{\sigma_{bd}}{x}. \quad (39)$$

If the upper and lower reinforcement are of equal area, $x = \frac{h}{2}$ and

$$M = \left[\frac{bh^2}{6} + \frac{4(n-1)f_c}{h} \left(\frac{h}{2} - a \right)^2 \right] \sigma_{bd}. \quad (40)$$

For the usual types of structural members, slabs and beams of rectangular section and with reinforcement only on the tension side, simplifications of the expressions (2) (4) and (5) may be made. If the applied moment as well as the sections of the concrete and of the reinforcement are given, and if it is desired

to find the resulting stresses, the relation $f_c = b \frac{(h-a)}{m}$ may be assumed, wherein

$m = \frac{b(h-a)}{f_c}$ may be found for different conditions. For various values of m ,

Table A (Appendix) may be employed for the determination of the proper values of x, σ_b and σ_e .

TABLE A

| Value of f_e | Corresponding Value of x . | Stress σ_b | Stress σ_c |
|----------------------|------------------------------|----------------------------------|---|
| $\frac{b(h-a)}{100}$ | $0.418(h-a)$ | $5.559 \cdot \frac{M}{b(h-a)^2}$ | $116 \frac{M}{b(h-a)^2} = 20.867\sigma_b$ |
| $\frac{b(h-a)}{110}$ | $0.403(h-a)$ | $5.735 \cdot \frac{M}{b(h-a)^2}$ | $127 \frac{M}{b(h-a)^2} = 22.145\sigma_b$ |
| $\frac{b(h-a)}{120}$ | $0.391(h-a)$ | $5.895 \cdot \frac{M}{b(h-a)^2}$ | $138 \frac{M}{b(h-a)^2} = 23.409\sigma_b$ |
| $\frac{b(h-a)}{130}$ | $0.379(h-a)$ | $6.040 \cdot \frac{M}{b(h-a)^2}$ | $149 \frac{M}{b(h-a)^2} = 24.668\sigma_b$ |
| $\frac{b(h-a)}{140}$ | $0.368(h-a)$ | $6.194 \cdot \frac{M}{b(h-a)^2}$ | $160 \frac{M}{b(h-a)^2} = 25.831\sigma_b$ |
| $\frac{b(h-a)}{150}$ | $0.358(h-a)$ | $6.344 \cdot \frac{M}{b(h-a)^2}$ | $170 \frac{M}{b(h-a)^2} = 26.797\sigma_b$ |
| $\frac{b(h-a)}{160}$ | $0.349(h-a)$ | $6.485 \cdot \frac{M}{b(h-a)^2}$ | $181 \frac{M}{b(h-a)^2} = 27.911\sigma_b$ |
| $\frac{b(h-a)}{170}$ | $0.341(h-a)$ | $6.617 \cdot \frac{M}{b(h-a)^2}$ | $192 \frac{M}{b(h-a)^2} = 29.016\sigma_b$ |
| $\frac{b(h-a)}{180}$ | $0.333(h-a)$ | $6.756 \cdot \frac{M}{b(h-a)^2}$ | $203 \frac{M}{b(h-a)^2} = 30.049\sigma_b$ |
| $\frac{b(h-a)}{190}$ | $0.326(h-a)$ | $6.883 \cdot \frac{M}{b(h-a)^2}$ | $213 \frac{M}{b(h-a)^2} = 30.946\sigma_b$ |
| $\frac{b(h-a)}{200}$ | $0.320(h-a)$ | $7.000 \cdot \frac{M}{b(h-a)^2}$ | $224 \frac{M}{b(h-a)^2} = 32.000\sigma_b$ |

If the dimensions are sought, when the applied moments and the concrete and steel stresses are given, x is first found from equation (6), $x = s(h-a)$, where $s = \frac{n\sigma_b}{\sigma_c + n\sigma_b}$. This value inserted in equation (4) gives

$$h-a = \sqrt{\frac{2}{\left(1-\frac{s}{3}\right)s\sigma_b}} \sqrt{\frac{M}{b}} = r\sqrt{\frac{M}{b}} \dots \dots \dots (41)$$

The expression for f_e , from equation (5) is

$$f_e = \frac{M}{\sigma_c \left(h-a - \frac{s(h-a)}{3} \right)},$$

or when $h-a = r\sqrt{\frac{M}{b}}$, this becomes

$$f_e = \frac{1}{r\left(1-\frac{s}{3}\right)\sigma_c} \sqrt{Mb} = t\sqrt{Mb} \dots \dots \dots (42)$$

The values of x , $h-a$, and f_c , found according to this method for different values of σ_c and σ_b may be tabulated.*

Such a table may also be used for T-beams, when the neutral axis coincides with the under side of the slab, or when such a location of the axis is made a condition of the design.

B. CENTRAL LOADING

If F is the area of the concrete under pressure, and f_e is the total area of reinforcement, the permissible load will be

$$P = (F + n f_e) \sigma_b, \dots \dots \dots (43)$$

so that

$$\sigma_b = \frac{P}{F + n f_e}, \dots \dots \dots (44)$$

$$\sigma_c = n \sigma_b = \frac{n P}{F + n f_e}, \dots \dots \dots (45)$$

C. ECCENTRIC LOADING

The calculations are to be made as for homogeneous materials, the area of reinforcement being replaced by an equivalent concrete area n -times larger in all expressions for areas of sections and moments of inertia. Tensile stresses which may occur are to be cared for by reinforcement.

D. EXAMPLES

1. The maximum stresses in the steel and the concrete are to be ascertained for a freely supported dwelling floor of 2 m. span and 10 cm. thick, reinforced with 5.02 cm²/m width (10 rods of 8 mm. diameter) placed 1.5 cm. from the bottom of the slab to the centers of the rods.

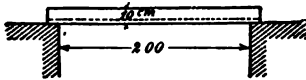

FIG. 7.

| | |
|--|---------|
| The dead weight of the floor per m ² is 0.10 × 2400 | 240 kg. |
| Over which is placed 10 cm. of rolled cinders | 60 kg. |
| A wooden floor 3.3 cm. thick with stringers | 20 kg. |
| A finish 1.2 cm. thick | 20 kg. |
| Live load | 250 kg. |
| Total | 590 kg. |

* The original contains such a table with steel stresses varying from 14,223 to 11,379 lbs/in², and concrete stresses from 640 to 284 lbs/in². This table has not been translated because these values are so far below usual American practice that it would be of no practical value. —(TRANS.)

Then

$$M = \frac{590 \times 2.1^2 \times 100}{8} = 32,500 \text{ kg.-cm.};$$

$$x = \frac{15 \times 5.02}{100} \left[\sqrt{1 + \frac{2 \times 100 \times 8.5}{15 \times 5.02}} - 1 \right] = 2.9 \text{ cm.};$$

$$\sigma_b = \frac{2 \times 32,500}{100 \times 2.9(8.5 - 0.97)} = 29.8 \text{ kg/cm}^2;$$

$$\sigma_e = \frac{32,500}{5.02(8.5 - 0.97)} = 860 \text{ kg/cm}^2.$$

The concrete compressive stress of 29.8 kg/cm² is permissible if the concrete employed has an ultimate compressive strength of 6 × 29.8 = 178.8 kg/cm².

By using Table 1, since $f_e = 5.02$, there are found,

$$m = \frac{100 \times 8.5}{5.02} = 170 \text{ approx.};$$

$$\sigma_b = \frac{6.617 \times 32,500}{100 \times 8.5^2} = 29.8 \text{ kg/cm}^2;$$

$$\sigma_e = 29.016 \times 29.8 = 865 \text{ kg/cm}^2.$$

To ascertain the shear and adhesive stresses at the supports, $V = \frac{590 \times 2.00}{2} = 590$ kg. must be found. Then the shearing stress is

$$\tau_0 = \frac{V}{b \left(h - a - \frac{x}{3} \right)} = \frac{590}{100 \left(8.5 - \frac{2.9}{3} \right)} = 0.78 \text{ kg/cm}^2.$$

The adhesive stress is then

$$\tau_1 = \frac{b\tau_0}{u},$$

in which u represents the circumference of the reinforcement.

$$\tau_1 = \frac{100 \times 0.78}{10 \times 0.8 \times 3.14} = 3.10 \text{ kg/cm}^2.$$

Neither shearing or adhesive stresses reach the maximum permissible limits.

2. A simply supported T-beam, with single reinforcement is assumed, with a span of 2 m. The live load is 1000 kg/m², for a factory. The necessary size of concrete and reinforcement is to be ascertained on the assumption that the concrete employed will develop a compressive strength of 180 kg/cm².

For the calculation of the dead load, the thickness of the slab will be tentatively assumed as 18 cm., so that the total span considered is 2.18 m.

| | |
|--|---------|
| The dead weight of the slab per sq.m. is 0.18 × 2400 = | 432 kg. |
| The covering of cinders 20 cm. thick | 120 kg. |
| Cement finish 2.5 cm. thick | 48 kg. |
| Total | 600 kg. |

$$\text{Then } M = \frac{600 + 1.5 \times 1000}{8} \times 2.18^2 \times 100 = 124,700 \text{ kg.-cm.}$$

Since $\sigma_b = \frac{180}{6} = 30$ and $\sigma_e = 1000 \text{ kg/cm}^2$ are the permissible stresses, according to equation (6),

$$x = \frac{15 \times 30}{1000 + 15 \times 30} (h - a) = 0.31 (h - a),$$

and then by equation (41),

$$h - a = \sqrt{\frac{2}{\left(1 - \frac{0.31}{3}\right) 0.31 \times 30}} \sqrt{\frac{124,700}{100}} = 17.3 \text{ cm.}$$

According to equation (1) f_e is found to be

$$f_e = \frac{bx^2}{2n(h-a-x)} = \frac{100 \times 0.31^2 \times 17.3^2}{2 \times 15(17.3 - 0.31 \times 17.3)} = 8 \text{ cm}^2.$$

Nine round rods, 11 mm. in diameter, with a total area of 8.55 cm² may be employed. The total thickness of slab on account of the covering for the steel must be increased to 19 cm.

From Table II* for $\sigma_e = 1000$, and $\sigma_b = 30$, there is found

$$h - a = 0.49 \sqrt{1247} = 17.3 \text{ cm.},$$

$$f_e = 0.00228 \sqrt{12,470,000} = 8 \text{ cm}^2.$$

The shear at the abutment is

$$V = 600 + 1.5 \times 1000 = 2100 \text{ kg.}$$

The shearing stress is

$$\tau_0 = \frac{2100}{100 \left(17.3 - \frac{0.31 \times 17.3}{3}\right)} = 1.36 \text{ kg/cm}^2.$$

The adhesion is

$$\tau_1 = \frac{100 \times 1.36}{9 \times 1.1 \times 3.14} = 4.38 \text{ kg/cm}^2.$$

3. The floor described under 2 is to be investigated as to the stresses which occur when the tensile strength of the concrete is taken into consideration.

According to equation (27), with the concrete also acting in tension,

$$x = \frac{\frac{100 \times 19^2}{2} + 15 \times 8.55 \times 17.3}{100 \times 19 + 15 \times 8.55} = 10.02 \text{ cm.},$$

* See Note page 346.—(TRANS.)

and according to equation (31),

$$\sigma_{bd} = \frac{124,700 \times 10.02}{\frac{100 \times 10.02^3}{3} + \frac{100 \times 8.98^3}{3} + 15 \times 8.55 \times 7.28^2} = 19.4 \text{ kg/cm}^2;$$

$$\sigma_{bz} = \frac{19 - 10.02}{10.02} \times 19.4 = 17.4 \text{ kg/cm}^2;$$

$$\sigma_e = \frac{15(17.3 - 10.02)}{10.02} \times 19.4 = 211.4 \text{ kg/cm}^2.$$

A tensile stress of 17.4 kg/cm² is permissible when an ultimate tensile strength of $\frac{3}{4} \times 17.4 = 26.1$ kg/cm² is demonstrated by experiment. If such test is not feasible, the concrete employed must show an ultimate compressive strength of $10 \times 17.4 = 174$ kg/cm². This ultimate compressive strength must reach 180 kg/cm² because of the assumed permissible stress of 30 kg/cm².

To determine the shearing stress at the neutral axis, the distance z between the centroids of tension and compression must be found. This is obtainable from the condition that $M = Dz$, where $D = \frac{bx}{2} \sigma_b = \frac{100 \times 19.4 \times 10.02}{2} = 9720$,

so that

$$z = \frac{124,700}{9720} = 12.83 \text{ cm.}$$

Then

$$\tau_0 = \frac{2100}{100 \times 12.83} = 1.64 \text{ kg/cm}^2.$$

Because of the tensile strength of the concrete, the shear at the level of the reinforcement is somewhat less. In general

$$\tau_0 = \frac{VS}{Jb},$$

wherein S is the statical moment of the section above* the level in question,† and J is the moment of inertia of the whole section. Thus, for the section of the level of the reinforcement,

$$S = 100 \left(\frac{8.98^2}{2} - \frac{7.28^2}{2} \right) + 15 \times 8.55 \times 7.28 = 3698;$$

$$J = \frac{Mx}{\sigma_b} = \frac{124,700 \times 10.02}{19.4} = 64,420;$$

so that

$$\tau_0' = \frac{2100 \times 3698}{64,420 \times 100} = 1.21 \text{ kg/cm}^2.$$

The adhesion is then

$$\tau_1' = \frac{100 \times 1.21}{9 \times 1.1 \times 3.14} = 4 \text{ kg/cm}^2.$$

* Or below, as in the example.—(TRANS.)

† With reference to the neutral axis.—(TRANS.)

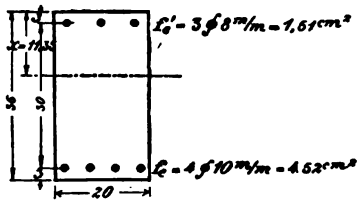

FIG. 8.

4. A reinforced concrete beam of 4 m. span, with dimensions as in the accompanying figure has an applied moment of 120,000 kg.-cm. The maximum compressive stress in the concrete and the stresses in the reinforcement, ignoring the tensile stress in the concrete, are required.

According to equation (17)

$$x = -\frac{14 \times 1.51 + 15 \times 4.52}{20} + \sqrt{\left(\frac{14 \times 1.51 + 15 \times 4.52}{20}\right)^2 + \frac{2}{20}(14 \times 151 + 15 \times 4.52 \times 33)} = 11.35 \text{ cm.}$$

Then, according to equation (19),

$$\sigma_b = \frac{120,000}{\frac{20 \times 11.35}{2}(33 - 3.78) + 14 \times 1.51 \times \frac{8.35}{11.35} \times 30} = 31.7 \text{ kg/cm}^2;$$

$$\sigma_s' = \frac{15 \times 8.35}{11.35} \times 31.7 = 350 \text{ kg/cm}^2;$$

$$\sigma_c = \frac{21.65}{8.35} \times 350 = 908 \text{ kg/cm}^2.$$

In computing the shearing stresses, the distance y_1 from equation (24) is to be found,

$$y_1 = \frac{\frac{20 \times 11.37^3}{3} + 14 \times 8.37^2 \times 1.51}{\frac{20 \times 11.37^2}{2} + 14 \times 8.37 \times 1.51} = 7.67 \text{ cm.}$$

Since the load per m. is 600 kg., $V = 2 \times 600 = 1200$ kg., and

$$\tau_0 = \frac{1200}{20(21.65 + 7.67)} = 2.05 \text{ kg/cm}^2;$$

$$\tau_1 = \frac{20 \times 2.05}{4 \times 1 \times 3.14} = 3.27 \text{ kg/cm}^2.$$

At the upper reinforcement, since

$$S = 20 \frac{11.35^2 - 8.35^2}{2} + 15 \times 1.51 \times 8.35 = 780,$$

and

$$J = \frac{120,000 \times 11.35}{31.7} = 42,970,$$

$$\tau_0' = \frac{1200 \times 780}{20 \times 42,970} = 1.09 \text{ kg/cm}^2,$$

$$\tau_1' = \frac{20 \times 1.09}{3 \times 0.8 \times 3.14} = 2.9 \text{ kg/cm}^2.$$

If the tensile stresses in the concrete are considered, according to equation (38),

$$x = \frac{\frac{20 \times 36^2}{2} + 14(1.51 \times 3 + 4.52 \times 33)}{20 \times 36 + 14(1.51 + 4.52)} = 18.8 \text{ cm.},$$

so that, according to equation (39),

$$\sigma_{bd} = \frac{120,000 \times 18.8}{\frac{20 \times 18.8^3}{3} + \frac{20 \times 17.2^2}{3} + 14(1.51 \times 15.8^2 + 4.52 \times 14.2^2)} = 23.4 \text{ kg/cm}^2;$$

$$\sigma_{bz} = \frac{17.2}{18.8} \times 23.4 = 21.4 \text{ kg/cm}^2;$$

$$\sigma_e = 15 \times \frac{14.2}{17.2} \times 21.4 = 265 \text{ kg/cm}^2.$$

The shearing stresses at the level of the upper reinforcement, since $J = 96,410$, will be

$$\tau_0 = \frac{1200}{96,410} \left(\frac{18.8^2 - 15.8^2}{2} + \frac{15 \times 1.51 \times 15.8}{20} \right) = 0.87 \text{ kg/cm}^2,$$

and the adhesive stress

$$\tau_1 = \frac{20 \times 0.87}{3 \times 0.8 \times 3.14} = 2.3 \text{ kg/cm}^2.$$

At the neutral axis,

$$\tau_0 = \frac{1200}{96,410} \left(\frac{18.8^2}{2} + \frac{15 \times 1.51 \times 15.8}{20} \right) = 2.4 \text{ kg/cm}^2.$$

5. A floor panel 3 m. wide and 4 m. long is to consist of a plain concrete slab, freely supported on all sides, with reinforcement in two directions parallel to the sides. Live and dead load amount to 600 kg/cm². The necessary thickness of floor and amount of reinforcement is required.

The applied moment, computed from the shortest span, is

$$M = \frac{600 \times 3.1^2 \times 100}{12} = 48,050 \text{ kg.-cm.}$$

The permissible stresses are $\sigma_e = 1000$ and $\sigma_b = 40$ kg/cm². Then, from Table II,*

$$h - a = 0.39 \sqrt{\frac{48,050}{100}} = 8.54 \text{ cm.},$$

$$f_e = 0.00293 \sqrt{4,805,000} = 6.42 \text{ cm}^2.$$

The thickness of the slab should be increased to 10 cm. For the reinforcement in the direction of the shorter span, 10 round rods of 9 mm. diameter with a total area of 6.36 cm²/m. width, should be used. The longer rods can be somewhat fewer, about in the ratio of the breadth to the length of the slab. For them, 8 rods per m. width, of the same size, may be employed.

* See note, page 346.—(TRANS.)

6. A T-beam of the dimensions shown in the accompanying figure is assumed with a span of 7.5 m. and a column spacing of 7.8 m., with a live load of 500 kg/m, in a store. The reinforcement consists of 6 round rods of 2.5 cm. diameter, with a total area of 29.45 cm². The maximum stresses in concrete and steel are to be determined.

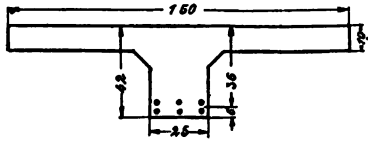

The dead load consists of:

| | |
|--|----------|
| The weight of the T-beam = $(1.5 \times 0.1 + 0.32 \times 0.25) \times 2400 \dots$ | 552 kg. |
| The weight of the floor filling, 6 cm. of rolled cinders . . . | 36 kg. |
| The weight of the cement finish, 2 cm. thick | 40 kg. |
| The weight of the plaster ceiling | 14 kg. |
| Total per sq. meter | 90 kg. |
| Thus, for 1.5 m ² , $1.5 \times 90 = \dots$ | 135 kg. |
| The live load | 500 kg. |
| Total | 1187 kg. |

or approximately, 1200 kg/m length of beam.

Then

$$M = \frac{1200 \times 7.8^2 \times 100}{8} = 912,600 \text{ kg.-cm.},$$

and, according to equation (11),

$$x = \frac{\frac{150 \times 10^2}{2} + 15 \times 29.45 \times 36}{150 \times 10 + 15 \times 29.45} = 12.05 \text{ cm.},$$

and according to equation (13)

$$y = 12.05 - 5 + \frac{10^2}{6(2 \times 12.05 - 10)} = 8.23 \text{ cm.},$$

consequently, according to equation (14)

$$\sigma_s = \frac{912,600}{29.45(36 - 12.05 + 8.23)} = 963 \text{ kg/cm}^2,$$

and according to equation (15)

$$\sigma_b = \frac{12.05}{15(36 - 12.05)} \times 963 = 32.3 \text{ kg/cm}^2.$$

The shear at the abutment is

$$V = \frac{7.5 \times 1200}{2} = 4500 \text{ kg.},$$

so that the shearing stress in the concrete is

$$\tau_0 = \frac{V}{b_1(h-a-x+y)} = \frac{4500}{25(36-12.05+8.23)} = 5.6 \text{ kg/cm}^2.$$

The permissible stress is thus exceeded. It is consequently advisable to bend upward near the end two rods of the upper layer of reinforcement. The point at which such bending should take place is determined by the condition that at this point the shear V should be only

$$\frac{4500 \times 4.5}{5.6} = 3616 \text{ kg.}$$

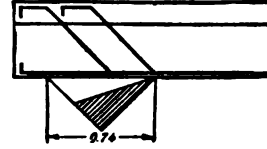

FIG. 10.

This is found at a point $\frac{4500 - 3616}{1200} = 0.74$ meters from the abutment.

The total tension Z to be taken by the bent portions of the rods is equal to the shear to be transferred to them, i.e.,

$$Z = \frac{74}{\sqrt{2}}(5.6 - 4.5) \frac{1}{2} \times 25 = 720 \text{ kg.}$$

The stress in the bent rods is therefore

$$\sigma_e = \frac{720}{2 \times 4.91} = 73 \text{ kg/cm}^2.$$

The adhesive stress on the four lower rods at the supports, amounts to

$$\tau_1 = \frac{b_1 \tau_0}{u} = \frac{25 \times 5.6}{4 \times 2.5 \times 3.14} = 4.5 \text{ kg/cm}^2.$$

If it is desired to ascertain the tension in the concrete, x must be determined from equation (32)

$$x = \frac{\frac{25 \times 42^2}{2} + \frac{125 \times 10^2}{2} + 15 \times 29.45 \times 36}{25 \times 42 + 125 \times 10 + 15 \times 29.45} = 16.12 \text{ cm.},$$

and according to equation (13)

$$y = 16.12 - 5 + \frac{100}{6(32.24 - 10)} = 11.87 \text{ cm.},$$

so that by equation (33a)

$$M = 912,600 = \left[\frac{150 \times 10 \times 11.87}{2} (2 \times 16.12 - 10) + \frac{25}{3} (6.12^3 + 25.88^3) + 15 \times 29.45 \times 19.88^2 \right] \frac{\sigma_{bd}}{16.12},$$

from which

$$\sigma_{bd} = 28.4 \text{ kg/cm}^2,$$

$$\sigma_{bz} = \frac{25.88}{16.12} \times 28.4 = 45.6 \text{ kg/cm}^2,$$

$$\sigma_e = 15 \times \frac{19.88}{16.12} \times 28.4 = 525 \text{ kg/cm}^2.$$

The stress $\sigma_{bs} = 45.6 \text{ kg/cm}^2$ is certainly too large, so that the width of the stem of the beam and the area of the reinforcement must be increased.

7. A continuous T-beam on four supports with the section shown in the accompanying illustration carries 500 kg/m, in a store. The maximum stresses in the concrete and the steel are required. The weight per m. length is:

$$(1.5 \times 0.10 + 0.3 \times 0.35) \times 2400 = \dots\dots\dots 612 \text{ kg.}$$

$$\text{To which is to be added the additional dead load of the last example. } 135 \text{ kg.}$$

$$\text{Total. } \dots\dots\dots 747 \text{ kg.}$$

or approximately 750 kg/m length of beam.

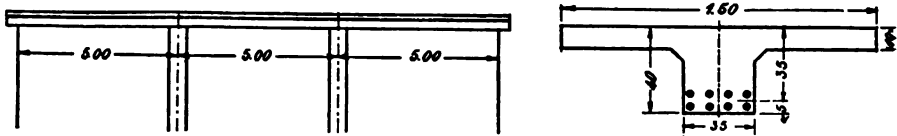

FIG. 11.

The calculations will be made on the assumption commonly made for continuous beams, of a uniform moment of inertia, ignoring the variations due to changes of size and location of reinforcement and of possible increase of strength over the supports. These points increase the factor of safety to some extent.

The applied moments are

(a) At 0.4 l of the first span:

$$M_g = +0.08 \times 750 \times 5.0^2 \times 100 = +150,000'$$

$$-M_p = -0.02 \times 500 \times 5.0^2 \times 100 = -25,000$$

$$+M_p = +0.10 \times 500 \times 5.0^2 \times 100 = +125,000$$

Thus,

$$M_{\max} = +275,000.$$

(b) Over the center supports:

$$M_g = -0.10000 \times 750 \times 5.0^2 \times 100 = -187,500$$

$$-M_p = -0.11667 \times 500 \times 5.0^2 \times 100 = -145,838$$

$$+M_p = +0.01667 \times 500 \times 5.0^2 \times 100 = +20,838$$

Thus,

$$M_{\max} = -333,338.$$

(c) In the center span:

$$M_g = +0.025 \times 750 \times 5.0^2 \times 100 = +46,875$$

$$-M_p = -0.050 \times 500 \times 5.0^2 \times 100 = -62,500$$

$$+M_p = +0.075 \times 500 \times 5.0^2 \times 100 = +93,750$$

Thus,

$$+M_{\max} = +140,625,$$

$$-M_{\max} = -15,625.$$

With these quantities the stresses are as follows:

(a) *At 0.4 l of the First Span.*—The reinforcement consists of 8 round rods of 15 mm. diameter and 14.14 cm² total area placed 5 cm. from the bottom of the beam.

Since the neutral axis falls within the slab, its location can be found by the help of equation (2)

$$x = \frac{15 \times 14.14}{150} \left[\sqrt{1 + \frac{2 \times 150 \times 35}{15 \times 14.14}} - 1 \right] = 8.63 \text{ cm.}$$

σ_b and σ_e are then given by equations (4) and (5) as

$$\sigma_b = \frac{2 \times 275,000}{150 \times 8.63 \times 32.12} = 13.2 \text{ kg/cm}^2,$$

$$\sigma_e = \frac{275,000}{14.14 \times 32.12} = 606 \text{ kg/cm}^2.$$

(b) *Over the Intermediate Supports.*—Since the concrete can carry no tensile stress, only the rectangular portion of the section with the reinforcement diverted to the top, is effective for the negative moments over the supports. Consequently, two additional rods 15 mm. in diameter are inserted so that the aggregate area becomes 17.67 cm².

The determination of the position of the neutral axis is again made by equation (2)

$$x = \frac{15 \times 17.67}{35} \left[\sqrt{1 + \frac{2 \times 35 \times 35}{15 \times 17.67}} - 1 \right] = 16.66 \text{ cm.},$$

$$\sigma_b = \frac{2 \times 333,338}{35 \times 16.66 \times 29.45} = 38.8 \text{ kg/cm}^2,$$

$$\sigma_e = \frac{333,338}{17.67 \times 29.45} = 640 \text{ kg/cm}^2.$$

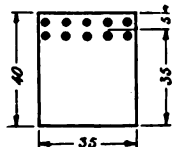

FIG. 12.

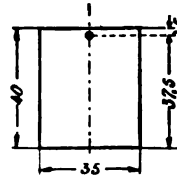

FIG. 13.

(c) *In the Central Span.*—The maximum positive moment is considerably smaller than at 0.4*l* of the first span. Four round rods with a total area of 7.07 cm², are sufficient.

$$x = \frac{15 \times 7.07}{150} \left[\sqrt{1 + \frac{2 \times 150 \times 37.25}{15 \times 7.07}} - 1 \right] = 6.58 \text{ cm.},$$

$$\sigma_b = \frac{2 \times 140,625}{150 \times 6.58 \times 35.06} = 8.1 \text{ kg/cm}^2,$$

$$\sigma_e = \frac{140,625}{7.07 \times 35.06} = 565 \text{ kg/cm}^2.$$

One round rod 1 cm. in diameter with an area of 0.79 cm² in the upper part of the section, is sufficient for the negative moment of -15,625. Then

$$x = \frac{15 \times 0.79}{35} \left[\sqrt{1 + \frac{2 \times 35 \times 37.5}{15 \times 0.79}} - 1 \right] = 4.71 \text{ cm.},$$

$$\sigma_e = \frac{15,625}{0.79 \times 35.93} = 550 \text{ kg/cm}^2.$$

If it is desired to ascertain in this case, and for 0.4*l* of the first span, what is the tensile stress in the concrete, there follows,

$$x = \frac{\frac{35 \times 40^2}{2} + \frac{115 \times 10^2}{2} + 15 \times 14.14 \times 35}{35 \times 40 + 115 \times 10 + 15 \times 14.14} = 14.9 \text{ cm.},$$

$$y = 14.9 - 5 + \frac{10^2}{6(29.8 - 10)} = 10.74 \text{ cm.}$$

Then, according to equation (33a),

$$275,000 = \frac{\sigma_{bd}}{14.9} \left[\frac{150}{2} \times 10 \times 10.74(29.8 - 10) + \frac{35}{3}(4.9^3 + 25.1^3) + 15 \times 14.14 \times 20.1^2 \right].$$

$$275,000 = 29,000 \sigma_{bd};$$

$$\sigma_{bd} = \frac{275,000}{29,000} = 9.5 \text{ kg/cm}^2;$$

$$\sigma_{bs} = \frac{25.1}{14.9} \times 9.5 = 16 \text{ kg/cm}^2.$$

The determination of the shearing and adhesive stresses is made as in the last example.

8. A reinforced concrete column 30×30 cm. in section, with 4 round rods of 16 cm² area, is centrally loaded with 30,000 kg. The induced stresses in concrete and steel are to be calculated.

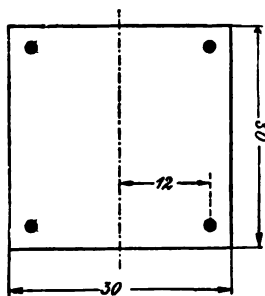

FIG. 14.

According to equations (43) to (45) there will result

$$30,000 = \sigma_b(30 \times 30 + 15 \times 16);$$

$$\sigma_b = \frac{30,000}{1140} = 26.3 \text{ kg/cm}^2;$$

$$\sigma_e = 15 \times 26.3 = 395 \text{ kg/cm}^2.$$

9. The same column is to be investigated for buckling; conditioned on its height being 4 m.

In Euler's formula

$$P = \frac{\pi^2 EJ}{l^2},$$

$E = \frac{2,100,000}{15} = 140,000$ is the value assumed for concrete and $s =$ the factor of safety $= 10$.

$$J = \frac{30^4}{12} + 15 \times 4 \times 4.0 \times 12^2 = 102,060,$$

so that

$$P = \frac{10 \times 140,000 \times 102,060}{10 \times 160,000} = 89,303 \text{ kg.}$$

Since, in the problem, P is only 30,000 kg., no risk is experienced of the buckling of the column. In order that no buckling should occur in the reinforcement, the condition must exist that

$$\frac{\pi^2 EJ}{5l^2} = Fk.$$

The stress k of the steel has been found to approximate 395 kg/cm². Since, for round rods

$$F = \frac{\pi d^2}{4} \quad \text{and} \quad J = \frac{\pi d^4}{64},$$

it follows that

$$\frac{J}{F} = \frac{d^2}{16},$$

and the permissible length of rod to prevent buckling is

$$l = d \sqrt{\frac{10 \times 2,100,000}{80 \times 395}} = 25.8d.$$

In order to avoid a buckling of the rods, they are to be connected by ties at distances not exceeding $25.8 \times 2.26 = 58$ cm. According to Sec. 15, No. 6, the extreme tie spacing should not be greater than 30 cm.

10. A reinforced concrete column 25×25 cm. in section, with four reinforcing rods of 2 cm. diameter, has a load of 5000 kg. placed eccentrically at a distance of 10 cm. from the center. The resulting concrete and steel stresses are required.

Two conditions apply to the solution of this problem:

1. The sum of the external and internal forces must be equal to zero; $\Sigma V = 0$.

2. The sum of the statical moments of the forces acting on a section must be zero; $\Sigma M = 0$.

Further, the condition must hold, that stresses* are to each other as the distances from the neutral axis multiplied by the modulus of elasticity, that is,

$$\sigma_b : \sigma_{ed} = x : n(x - a)$$

$$\sigma_b : \sigma_{ez} = x : n(h - a - x).$$

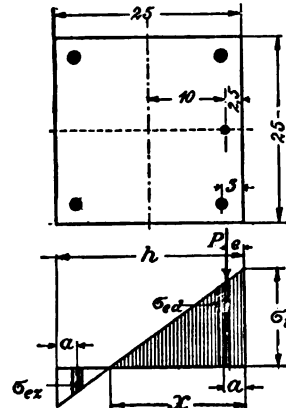

FIG. 15.

* Stresses in concrete and in steel.—(TRANS.)

From the first condition

$$(a) \quad P = \frac{bx}{2}\sigma_b + n f_e \sigma_b \left(\frac{x-a}{x} - \frac{h-a-x}{x} \right) = \sigma_b \left[\frac{bx}{2} + \frac{n f_e}{x} (2x-h) \right],$$

and from condition 2

$$(b) \quad P(x-e) = \sigma_b \frac{bx^2}{3} + n f_e \sigma_b \left[\frac{(x-a)^2}{x} + \frac{(h-a-x)^2}{x} \right] \\ = \sigma_b \left[\frac{bx^2}{3} + \frac{n f_e}{x} (2x^2 - 2hx + 2a^2 + h^2 - 2ah) \right].$$

Equating the value of σ_b obtained from these equations and reducing, there results

$$\frac{b}{6n f_e} x^3 - \frac{be}{2n f_e} x^2 - (2e-h)x = 2a^2 + h^2 - (2a+e)h,$$

or by substituting the values, $b=25$; $n=15$; $f_e=6.28$; $e=2.5$; $h=25$; $a=3$;

$$\frac{25}{6 \times 15 \times 6.28} x^3 - \frac{25 \times 2.5}{2 \times 15 \times 6.28} x^2 + 20x = 2 \times 3^2 + 25^2 - 8.5 \times 25, \\ x^3 - 7.5x^2 + 452.16x = 9734.$$

The solution is most easily accomplished by trial and there is found with sufficient accuracy

$$x = 16.3 \text{ cm.}$$

Then, by the aid of equation (a)

$$5000 = \sigma_b \left(\frac{25 \times 16.3}{2} + \frac{15 \times 6.28}{16.3} \times 7.6 \right), \\ \sigma_b = 20.2 \text{ kg/cm}^2,$$

and further,

$$\sigma_{ed} = \frac{15 \times 13.3 \times 20.2}{16.3} = 249 \text{ kg/cm}^2,$$

$$\sigma_{ee} = 249 \frac{5.7}{13.3} = 107 \text{ kg/cm}^2.$$

TABLE B
 MAXIMUM MOMENTS IN CONTINUOUS BEAMS

CONTINUOUS BEAMS OF TWO SPANS 1:1

| $\frac{x}{l}$ | MOMENTS | | |
|---------------|----------|---------------|---------------|
| | From g | From p | |
| | M | Max. (+ M) | Max. (- M) |
| 0 | 0 | + | - |
| 0.1 | +0.0325 | 0.03875 | 0.00625 |
| 0.2 | +0.0550 | 0.06750 | 0.01250 |
| 0.3 | +0.0675 | 0.08625 | 0.01875 |
| 0.4 | +0.0700 | 0.09500 | 0.02500 |
| 0.5 | +0.0625 | 0.09375 | 0.03125 |
| 0.6 | +0.0450 | 0.08250 | 0.03750 |
| 0.7 | +0.0175 | 0.06125 | 0.04375 |
| 0.75 | 0 | 0.04688 | 0.04688 |
| 0.8 | -0.0200 | 0.03000 | 0.05000 |
| 0.85 | -0.0425 | 0.01523 | 0.05773 |
| 0.9 | -0.0675 | 0.00611 | 0.07361 |
| 0.95 | -0.0950 | 0.00138 | 0.09638 |
| 1 | -0.1250 | 0 | 0.12500 |
| | gl^2 | pl^2 | pl^2 |

Note.—In this and the following table, in cases in which the calculations include only quiescent loads, as for roofs, it is recommended that the positive moments at centers of spans be increased to at least $\frac{gl^2}{20}$. In computations concerning partial live loads p in unfavorable positions, the deficient value due to g found in the table is overbalanced, so that the tabular values can be employed as they stand.

In beams with more than four spans, the end ones can be calculated like the first one of a beam of four spans, and the other spans in the longer beam like the second span of a continuous beam of four spans.

TABLE C
 MAXIMUM MOMENTS IN CONTINUOUS BEAMS

CONTINUOUS BEAMS OF THREE SPANS 1:1:1

| $\frac{x}{l}$ | MOMENTS | | |
|----------------|----------|---------------|---------------|
| | From g | From p | |
| | M | Max. (+ M) | Max. (- M) |
| First opening | | - | + |
| 0 | 0 | 0 | 0 |
| 0.1 | +0.035 | 0.005 | 0.040 |
| 0.2 | +0.060 | 0.010 | 0.070 |
| 0.3 | +0.075 | 0.015 | 0.090 |
| 0.4 | +0.080 | 0.020 | 0.100 |
| 0.5 | +0.075 | 0.025 | 0.100 |
| 0.6 | +0.060 | 0.030 | 0.090 |
| 0.7 | +0.035 | 0.035 | 0.070 |
| 0.8 | 0 | 0.04022 | 0.04022 |
| 0.85 | -0.02125 | 0.04898 | 0.02773 |
| 0.9 | -0.04500 | 0.06542 | 0.02042 |
| 0.95 | -0.07125 | 0.08831 | 0.01706 |
| 1 | -0.10000 | 0.11667 | 0.01667 |
| Second opening | | | |
| 0 | -0.10000 | 0.11667 | 0.01667 |
| 0.05 | -0.07625 | 0.09033 | 0.01408 |
| 0.1 | -0.05500 | 0.06248 | 0.00748 |
| 0.15 | -0.03625 | 0.05678 | 0.02053 |
| 0.2 | -0.020 | 0.050 | 0.030 |
| 0.2764 | 0 | 0.050 | 0.050 |
| 0.3 | +0.005 | 0.050 | 0.055 |
| 0.4 | +0.020 | 0.050 | 0.070 |
| 0.5 | +0.025 | 0.050 | 0.075 |
| | g^2 | p^2 | p^2 |

TABLE D
 MAXIMUM MOMENTS IN CONTINUOUS BEAMS

CONTINUOUS BEAMS OF FOUR SPANS 1:1:1:1

| $\frac{x}{l}$ | MOMENTS | | |
|----------------|----------|---------------|---------------|
| | From g | From p | |
| | M | Max. ($-M$) | Max. ($+M$) |
| First opening | | - | + |
| o | o | o | o |
| o.1 | +0.03429 | 0.00536 | 0.03964 |
| o.2 | +0.05857 | 0.01071 | 0.06929 |
| o.3 | +0.07286 | 0.01607 | 0.08893 |
| o.4 | +0.07714 | 0.02143 | 0.09857 |
| o.5 | +0.07143 | 0.02679 | 0.09822 |
| o.6 | +0.05572 | 0.03214 | 0.08786 |
| o.7 | +0.03000 | 0.03750 | 0.06750 |
| o.7857 | o | 0.04209 | 0.04209 |
| o.8 | -0.00571 | 0.04309 | 0.03738 |
| o.85 | -0.02732 | 0.05216 | 0.02484 |
| o.9 | -0.05143 | 0.06772 | 0.01629 |
| o.95 | -0.07803 | 0.09197 | 0.01393 |
| 1.0 | -0.10714 | 0.12054 | 0.01340 |
| Second opening | | | |
| o | -0.10714 | 0.12054 | 0.01340 |
| o.05 | -0.08160 | 0.09323 | 0.01163 |
| o.1 | -0.05857 | 0.07212 | 0.01455 |
| o.15 | -0.03803 | 0.06340 | 0.02537 |
| o.2 | -0.02000 | 0.05000 | 0.03000 |
| o.2661 | o | 0.04882 | 0.04882 |
| o.3 | +0.00857 | 0.04821 | 0.05678 |
| o.4 | +0.02714 | 0.04643 | 0.07357 |
| o.5 | +0.03572 | 0.04464 | 0.08036 |
| o.6 | +0.03429 | 0.04286 | 0.07715 |
| o.7 | +0.02286 | 0.04107 | 0.06393 |
| o.8 | +0.00143 | 0.04027 | 0.04170 |
| o.8053 | o | 0.04092 | 0.04092 |
| o.85 | -0.01303 | 0.04754 | 0.03451 |
| o.9 | -0.03000 | 0.06105 | 0.03105 |
| o.95 | -0.04947 | 0.08120 | 0.03173 |
| 1.0 | -0.07143 | 0.10714 | 0.03571 |
| | gl^2 | pl^2 | pl^2 |

TABLE E
CONVERSION TABLE, METRIC TO ENGLISH

| No. | Kilograms to Averdupois Pounds. | Tonnes to Tons of 2000 Pounds. | Centimeters to Inches. | Meters to Feet. | Square Centimeters to Square Inches. | Square Meters to Square Feet. |
|-----|---------------------------------------|--------------------------------------|---------------------------|--------------------|---|--|
| 1 | 2.20462 | 1.10231 | 0.39370 | 3.280833 | 0.155 | 10.76387 |
| 2 | 4.40924 | 2.20462 | 0.78740 | 6.561667 | 0.310 | 21.52773 |
| 3 | 6.61387 | 3.30693 | 1.18110 | 9.842500 | 0.465 | 32.29160 |
| 4 | 8.81849 | 4.40924 | 1.57480 | 13.123333 | 0.620 | 43.05547 |
| 5 | 11.02311 | 5.51156 | 1.96850 | 16.404167 | 0.775 | 53.81934 |
| 6 | 13.22773 | 6.61387 | 2.36220 | 19.685000 | 0.930 | 64.58320 |
| 7 | 15.43236 | 7.71618 | 2.75590 | 22.965833 | 1.085 | 75.34707 |
| 8 | 17.63698 | 8.81849 | 3.14960 | 26.246667 | 1.240 | 86.11094 |
| 9 | 19.84160 | 9.92080 | 3.54330 | 29.527500 | 1.395 | 96.87481 |

| No. | Cubic Meters to Cubic Yards. | Hektoliters to Bushels. | Kilograms per Square Centimeters to Pounds per Square Inch. | Kilograms per Square Meter to Pounds per Square Foot. | Kilograms per Cubic Meter to Pounds per Cubic Foot. |
|-----|---------------------------------|----------------------------|---|--|--|
| 1 | 1.30794 | 2.83774 | 14.22340 | 0.20482 | 0.06243 |
| 2 | 2.61589 | 5.67548 | 28.44680 | 0.40963 | 0.12486 |
| 3 | 3.92383 | 8.51323 | 42.67020 | 0.61445 | 0.18728 |
| 4 | 5.23177 | 11.35097 | 56.89359 | 0.81927 | 0.24971 |
| 5 | 6.53971 | 14.18871 | 71.11699 | 1.02408 | 0.31214 |
| 6 | 7.84766 | 17.02645 | 85.34039 | 1.22890 | 0.37457 |
| 7 | 9.15560 | 19.86420 | 99.56379 | 1.43372 | 0.43700 |
| 8 | 10.46354 | 22.70194 | 113.78719 | 1.63854 | 0.49943 |
| 9 | 11.77149 | 25.53968 | 128.01059 | 1.84335 | 0.56185 |

INDEX

| | PAGE |
|---|--------------------|
| A DHESION | 42 |
| proof of existence of | 2 |
| Adhesive forces, formulas for | 145, 146 |
| stresses developed | 157, 161, 184, 186 |
| Anchorage for ends of rods | 148, 149 |
| Arch bridges, examples | 266-284 |
| Arches | 14 |
| in buildings | 235 |
| B EAMS, graphical methods of calculating | 130-137 |
| of variable depth, shear in | 190, 191 |
| Bending and tensile strengths, explanation of discrepancy between | 26, 27, 28 |
| relation of | 27-29 |
| of rods, effects of | 181, 182 |
| strength of concrete | 25 |
| tests to determine extensibility | 55, 56 |
| with axial compression, formula for | 119-123 |
| with axial stress, graphical methods for | 132-137 |
| with axial tension | 127-129 |
| with axial thrust | 119-127 |
| Beton Frette | 67 |
| Brackets | 8, 9 |
| Breaking strength of columns | 63 |
| Brick curtain walls | 215 |
| Buildings of reinforced concrete, examples of | 210 |
| C ANTILEVERS, examples | 257 |
| Cellars, Water-tight | 247 |
| Cement bins, examples | 295-298 |
| Coal pockets, examples | 290 |
| Coefficient of expansion, concrete | 3 |
| steel | 3 |

| | PAGE |
|---|---------------|
| Column tests | 60, 61 |
| Columns | 11 |
| breaking strength of | 63 |
| effect of ties on | 62 |
| flexure of | 65 |
| with longitudinal rods | 59 |
| with spiral reinforcement | 67 |
| Compression | 59 |
| Compressive strength of concrete | 19, 20 |
| Computation, suggested methods of | 323, 333, 340 |
| Concrete, bending strength of | 25 |
| compressive strength of | 19 |
| elasticity of | 21 |
| extensibility of | 50 |
| punching resistance of | 31 |
| shearing strength of | 31 |
| tensile strength of | 20 |
| torsional strength of | 39, 40 |
| Continuous bridges, examples | 263-266 |
| T-beams, experiments with | 199-203 |
| slabs | 5, 6 |
| Cooling towers, example of | 313-315 |
| Corrosion, proof of prevention of | 1, 2 |
| Cracking of T-beams | 188-190 |
| stage, methods of computation for | 137, 138 |
| Cracks, safety against tension | 105, 106, 107 |
| Curtain walls of brick | 215 |
| D EFLECTION of beams | 192, 193 |
| of Isar-Grimwald arch bridge | 280 |
| Deformation | 192, 193 |
| Deformed bars, objections against | 17, 18 |
| Distributing rods | 5 |
| Domes | 235 |
| Double reinforcement, formulas for | 87, 88 |
| for slabs, with methods of figuring | 94 |
| tests of slabs with | 93 |
| E FFECTIVE depth, alteration of, from cracks | 171 |
| Effect of humidity on extensibility of reinforced concrete | 53-58 |
| Elasticity of concrete | 21 |
| Elastic limit of concrete | 21 |
| Examples of methods of computation | 326-333 |
| Expanded metal, objections against | 17 |
| Expansion by heat, coefficient of, concrete | 3 |
| coefficient of, steel | 3 |

INDEX

365

| | PAGE |
|--|------------------------------|
| E xtensibility | 50 |
| from bending tests | 55, 56, 57 |
| of reinforced concrete | 51, 52 |
| Euler's formula not applicable to long columns | 65 |
| F IREPROOF quality of reinforced concrete, | |
| example of | 212 |
| Flexure of columns | 65 |
| Floor systems | 209 |
| Footings | 241 |
| G OVERNMENT (Prussian) regulations | |
| Grain bins, examples | 304-306 |
| Graphical methods of calculating beams | 130-137 |
| Grimwald-Isar arch bridge | 271-280 |
| H AUNCHES | |
| in continuous beams, effect of | 6, 8, 9 203 |
| History | 204, 205 |
| Hooks, effects of | 158, 161, 162, 164, 178, 182 |
| Humidity, effect of on concrete | 4 |
| I NTERIOR treatment of reinforced concrete | |
| buildings | 224 |
| Isar-Grimwald arch bridge | 271-280 |
| K NEES | |
| | 8, 9, 10 |
| L EITSÄTZE | |
| Longitudinal and spiral reinforcement for columns | 15, 317, 333 |
| rods, effects of | 72, 73 64 |
| M ELAN arch bridges | |
| Methods of computation, suggested | 281-283 323, 333, 340 |
| Modulus of elasticity of concrete | 21-25 |
| Moments, computation of | 194-197 |
| in slabs | 6 |
| N EUTRAL axis, position of | |
| | 95-98 |
| O RE pockets, examples | |
| | 290, 293, 298 |
| P ILE formula | |
| Piles | 255 250 |
| Prussian government regulations for reinforced concrete work | 16 |

| | PAGE |
|--|----------------------------|
| Pumice concrete | 19 |
| Punching resistance of concrete | 31 |
| R EGULATIONS of Prussian government | 16 |
| Reinforcing rods, arrangement in columns | 12 |
| arrangement of, in arches | 11 |
| arrangement of, in slabs | 5, 6, 9, 10 |
| Remant stresses | 198 |
| Reservoirs, examples | 284-287 |
| Rich mixture, necessity of | 18 |
| Roof construction | 230 |
| coverings | 219-230 |
| Rust, proof of prevention of | 2 |
| S AFE stresses, suggested | 323-339 |
| Safety against tension cracks | 105-107 |
| Sand-boxes for Isar Grimwald arch bridge | 276 |
| Scherfestigkeit | 31, 32 |
| Schubfestigkeit | 31, 32 |
| Shearing forces, effects of | 139, 141, 147, 148 |
| experiments concerning, by author | 151-173 |
| experiments concerning at Stuttgart | |
| Testing Laboratory | 173, 174 |
| formulas for | 141-146 |
| theory of action of | 151 |
| strength of concrete | 31, 33, 34, 35, 36, 37, 38 |
| from slotted beams | 40, 41, 42 |
| relation of tensile and compressive to | 32, 33, 35, 42 |
| stresses | 31, 32 |
| in beams of variable depth | 190, 191 |
| in reinforced concrete | 31, 32, 55 |
| Shipping platform, example of | 312 |
| Shrinkage stresses | 198 |
| Simple bending | 74 |
| Silos, computation of stresses in | 306-312 |
| examples | 287-312 |
| Slab culverts, examples | 256 |
| Slabs | 4 |
| formulas for computation of | 77-82 |
| graphical computation of | 76 |
| tables for computation of | 83-86 |
| tests of simple | 90 |
| tests of, with double reinforcement | 93 |
| with double reinforcement, methods of figuring | 94 |
| Sliding resistance of rods in concrete | 43, 44, 45, 46, 47 |
| Slope of bent rods | 7 |

| | PAGE |
|--|--|
| Spiral and longitudinal reinforcement for columns | 72, 73 |
| reinforcement for columns | 231 |
| notes regarding | 71 |
| for columns, how computed | 67 |
| Spirally reinforced columns | 13 |
| Splitting effect of Thacher rods | 47 |
| Stages in simple bending | 74, 75 |
| Stairs | 232 |
| Steel, properties of | 16 |
| Stirrups | 8 |
| action of | 149, 150 |
| effects of | 155, 156, 158, 159, 164, 168, 175, 177, 178, 180, 181, 183, 184, 188 |
| on adhesion | 48, 49 |
| tests concerning effect of | 152 |
| Stress distribution over section | 98-104 |
| Stresses at failure | 172-179 |
| in T-beams | 112-113 |
| for slabs, working | 92 |
| Sunken well casings | 244 |
| Suspension system of reinforcement, tests concerning . . | 164, 165, 166, 168 |
| Systems of construction | 206-209 |
| T ABLES for beams subjected also to thrust | 125, 126, 127 |
| T-beam bridges, examples | 258-266 |
| T-beams | 8-107 |
| continuous, experiments with | 199-203 |
| cracking of | 188-190 |
| diagrams for | 115 |
| economical spacing of | 8 |
| experiments concerning, by Stuttgart Labora- tory | 176 |
| formulas for | 108-110, 114, 116, 117 |
| stresses in | 112 |
| Tensile strength of concrete | 20 |
| Tension bending with axial | 127, 128, 129 |
| Tests of spirally reinforced columns | 68, 69 |
| Thacher rods, splitting effect of | 47 |
| Theory, development of | 208 |
| Thrust, axial bending with | 119-127 |
| Ties in columns, effect of | 62-64 |
| Torsional strength of concrete | 39, 40 |
| Torsion tests on hollow cylinder | 53, 54, 55 |
| Truss action of reinforcement | 160, 161 |
| theory of | 161, 183, 187, 188 |
| Tunnel lining, example of | 312 |

| | PAGE |
|---|----------|
| V ARIABLE depth, shear in beams of | 190, 191 |
| W ATERTIGHT cellars | 247 |
| Weld, location of | 11 |
| Well casings | 244 |
| Wet mixture, strength of | 18-20 |
| Working stresses for slabs | 92 |





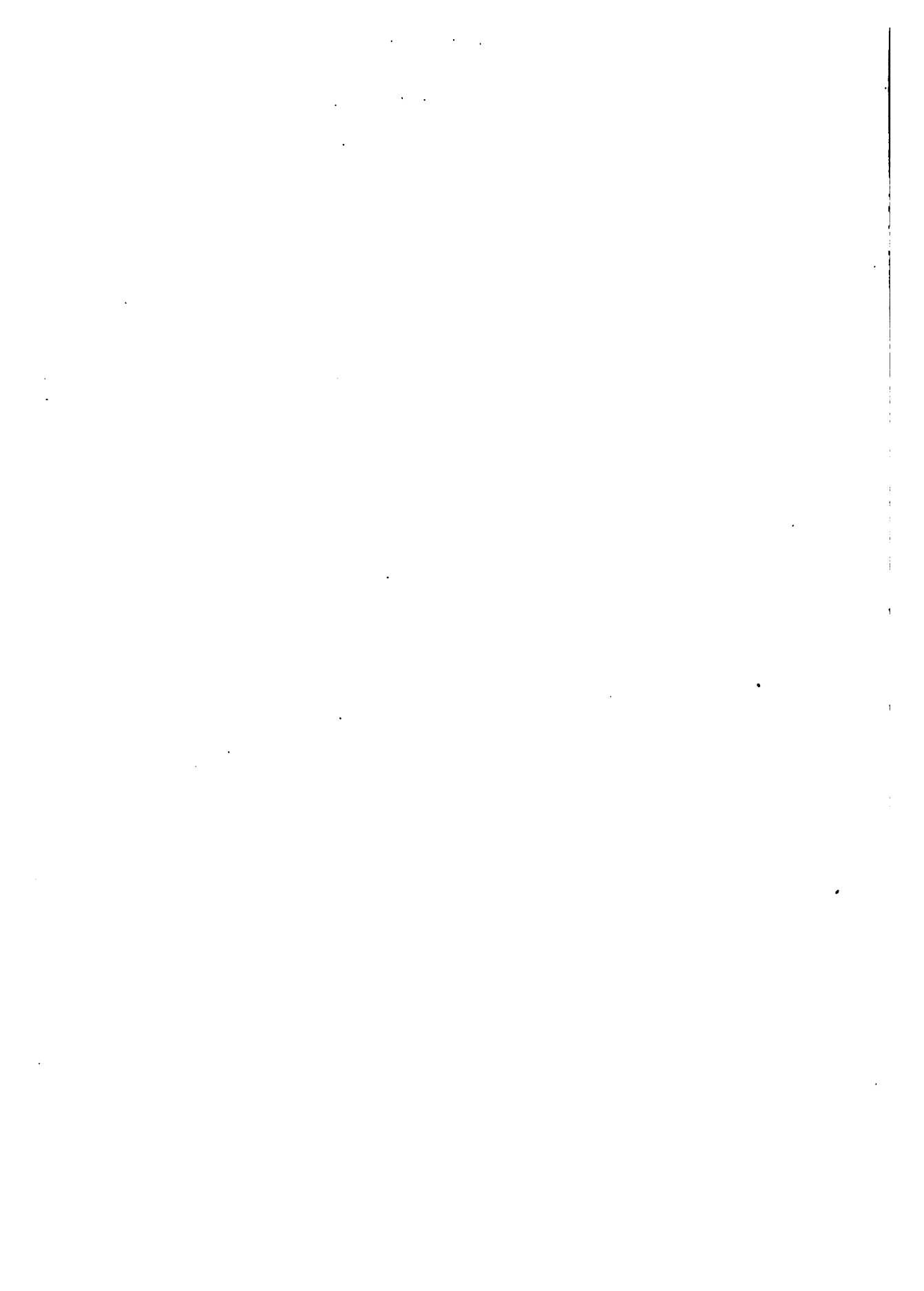

89080447535



b89080447535a

from asew

